

PETROGLYPH NATIONAL MONUMENT

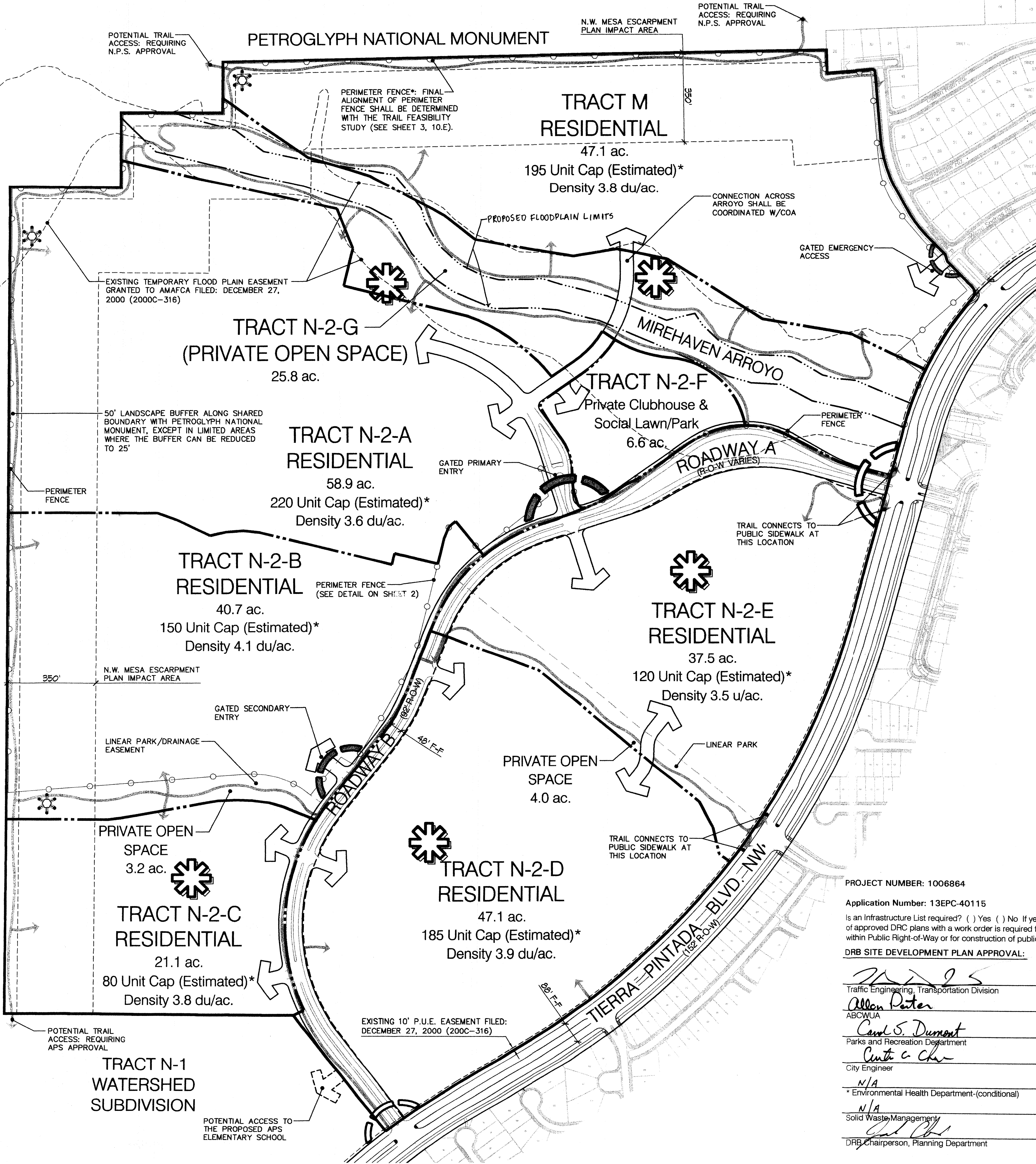

SITE PLAN FOR SUBDIVISION - REQUIRED INFORMATION

The Site: 284.8 acres comprised of Tract N-2 (237.7 acres) and Tract M (47.1 acres) within the Westside Strategic Plan, Northwest Mesa Escarpment Plan, Arroyo Facility Plan, Westland Master Plan, and Western Albuquerque Land Holdings Sector Plan area and subject to the regulations of those plans. The boundary between Tracts N-2 and M shall be vacated with plat. Development within the Northwest Mesa Escarpment Plan shall be subject to the applicable regulations contained in the Design Overlay Zone.

Zoning: SU-2 for PDA, see Westland Master Plan for details of regulations for SU-2 zones.

Land Use: R-T Uses. Single Family Residential Subdivision, Private Clubhouse (including indoor and outdoor recreational amenities), and private pocket parks and trails. Accessory structures are allowed. A Conditional Use permit shall be required for accessory living quarters (with a kitchen). No Commercial Use is allowed.

Pedestrian and Vehicular Ingress and Egress

Vehicular Access: Vehicular access is from Tierra Pintada, an existing minor arterial, via Roadways A and B. Roadway A (northern access point) is the primary access point to Watershed and Roadway B (southern access point) is the secondary access. There is also an emergency access and egress point north of the Mirehaven Arroyo within Tract A, which connects to Tierra Pintada. Anticipated access points into the individual neighborhoods have been identified along Roadways A and B and between the individual tracts. Final access shall be determined through preliminary and final plats as determined by the Development Review Board (DRB). A potential access point to the future APS Educational Campus has been provided from Roadway B, which will require coordination with APS.

Pedestrian Access/Circulation: There will be an extensive trail network developed as part of the project. The primary trail network will be along the naturalized arroyos through the property and along the Petroglyph National Monument boundary. Connections into the individual neighborhood will also be provided to ensure that all residents have access to the trails and interior private pocket parks. (See sheet 3 for more detail on trails).

Transit Access: Transit access is not currently available along Tierra Pintada, but additional transit service is anticipated as development occurs in this area.

Petroglyph National Monument Emergency Access: Vehicular access at the north-eastern corner of the proposed project shall be provided for emergency response in the event of an incident. Two public access points are shown, but these are dependent on a feasibility study and N.P.S. approval (See Sheet 3, 10.E).

Building Heights:

- Buildings within the 350 foot Impact Area of the Northwest Mesa Escarpment Plan (NWMEP) shall be limited to a building height of 15 feet, in accordance with the Design Overlay Zone.
- Buildings outside the 350 foot Impact Area of the Northwest Mesa Escarpment Plan shall be limited to 26 feet in height, with the exception of the Private Clubhouse, which is limited by the 40-foot height restriction of the SU-2/PDA zone as provided by the Westland Master Plan.

Setbacks:

- Minimum Front Yard Setbacks: 15 feet, except 20 feet for garages facing street.
- Minimum Rear Yard Setbacks: 15 feet.
- Minimum Rear Yard Setbacks for Alley-loaded Garages: 5 feet to allow for proper turning clearances.
- Minimum Side Yard Setbacks: 5 feet, except 10 feet for lots adjacent to roadway. Zero lot line is permitted provided 10 feet of separation between buildings is maintained. For single family attached units, no required side yard setback, except there shall be 10 feet on the street side of corner lots.

Density:

The overall density is established through the Westland North Sector Plan and Western Albuquerque Land Holdings Sector Plan. The Sector Plan calls for a maximum gross density of 4 dwelling units per acre. This project is consistent with that requirement and allows for a maximum of 950 dwellings (3.34 du/ac.).

TRACT	ACREAGE	LAND USE	*ESTIMATED UNIT CAP	DENSITY
M	47.1	Residential	195	3.8
N-2-A	58.9	Residential	220	3.6
N-2-B	40.7	Residential	150	4.1
N-2-C	21.1	Residential	80	3.8
N-2-D	47.1	Residential	185	3.9
N-2-E	37.5	Residential	120	3.3
N-2-F	6.6	Private Clubhouse	N/A	N/A
N-2-G	25.8	Private Open Space	N/A	N/A
TOTAL	284.8		950	3.34*

*Note: Density and Unit Cap may shift between tracts. However, the maximum number of dwelling units shall be 950.

Landscape Plan:

Future Landscape Plans will be prepared in conjunction with each phase and subdivision plat and shall be consistent with the design standards. These standards provide for landscaping along the public rights-of-way and along the internal drives (See Section 14, Sheet 9).

Approval Process:

- This Site Plan for Subdivision shall be submitted for final sign-off to the Development Review Board (DRB) concurrently with a Bulk Land Plat/Variance.
- The first tract to develop adjacent to Petroglyph National Monument shall return to the EPC for review of the Site Development Plan for Subdivision. At that time, the EPC can choose to delegate future Site Development Plans for Subdivision to administrative review or retain its approval authority and review a subsequent submission. Administrative review would consist of the Planning Director, or his/her designee, and an EPC staff planner performing a design review analysis with each site development plan for subdivision for the proposed tracts to ensure compliance with applicable rules, regulations, standards, and policies prior to submittal to the DRB.
- The applicant shall consult with the National Park Service and Parks and Recreation prior to approval of development adjacent to the Petroglyph National Monument.
- A data recovery plan has been completed for Tract N-2 (Tracts B-F), which has been cleared for construction by the SHPO. A data recovery plan shall be completed for Tract M (Tract A), prior to any building permits being issued for this portion of the property.
- An analysis of the operation and mitigation necessary to return traffic operations to that of the No-Build condition at the Ladera and Unser intersection is required. This analysis shall be performed and submitted to the City and NMDOT for review prior to the first subdivision plat approval by the DRB.

PROJECT NUMBER: 1006864

Application Number: 13EPC-40115

Is an Infrastructure List required? () Yes () No If yes, then a set of approved DRC plans with a work order is required for any construction within Public Right-of-Way or for construction of public improvements.

DRB SITE DEVELOPMENT PLAN APPROVAL:

<i>[Signature]</i>	09-11-13
Traffic Engineering, Transportation Division	Date
<i>[Signature]</i>	09/11/13
ABC/WJA	Date
<i>[Signature]</i>	9-24-13
Parks and Recreation Department	Date
<i>[Signature]</i>	9-11-13
City Engineer	Date
N/A	Date
* Environmental Health Department-(conditional)	Date
N/A	Date
Solid Waste Management	Date
<i>[Signature]</i>	9-20-13
DRB Chairperson, Planning Department	Date

SITE VICINITY MAP

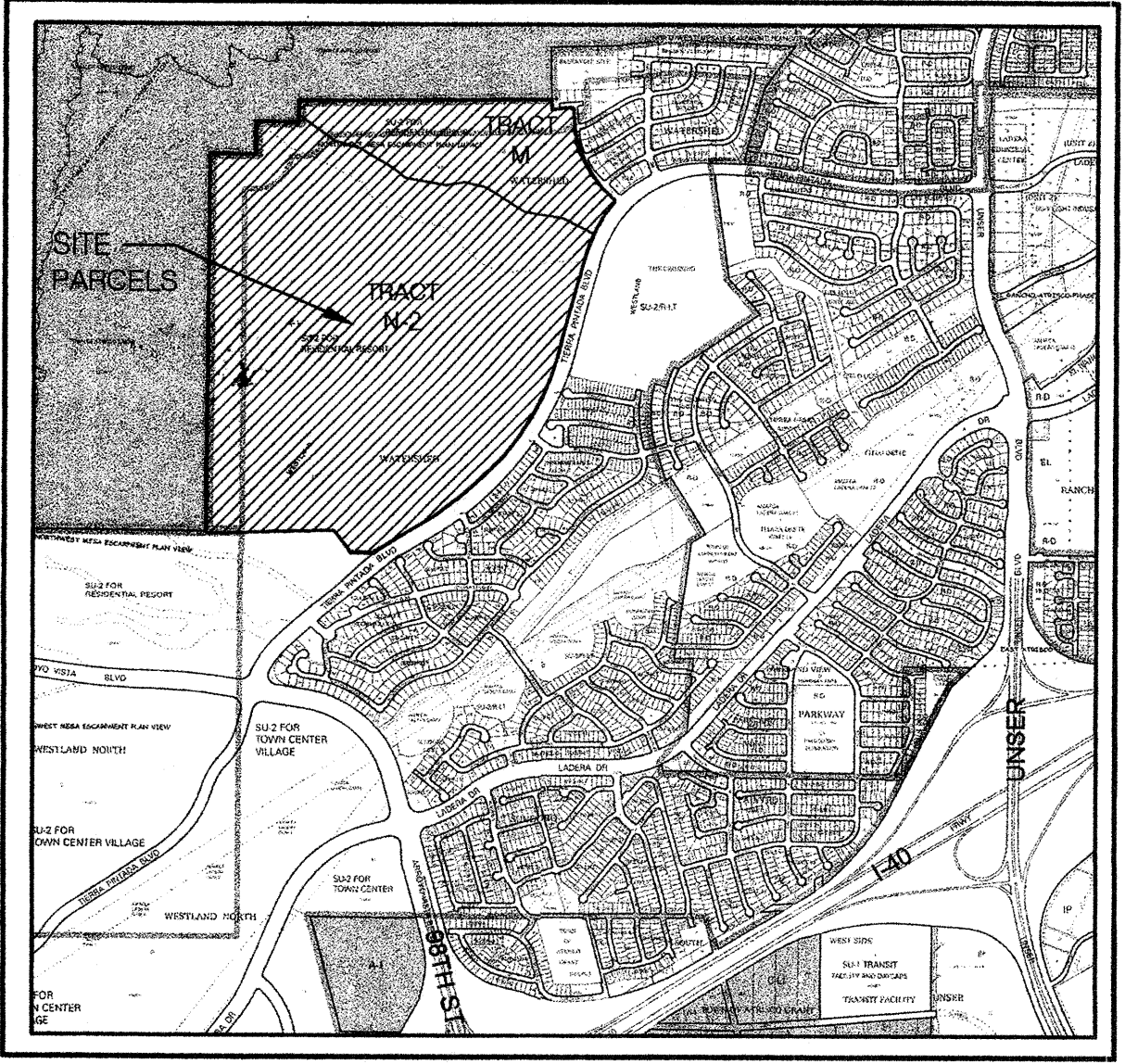

LEGEND

- Property Boundary
- Parcel Boundary
- Trailhead Park
- Private Pocket Park (Built and maintained by HOA-See sheet 3).
- Pedestrian/ Vehicular Access
- Trail & Pedestrian Access
- Potential APS Elementary School Access
- Gated Primary Entry/ Primary Entry
- Gated Secondary Entry/ Secondary Entry
- Gated Emergency Access
- Perimeter Fence

WATERSHED @ ESTRELLA

SITE PLAN FOR SUBDIVISION

Prepared For:
FulteGroup

Prepared By:
SEC Planning, LLC
Consensus Planning, Inc.
Bohannon Huston, Inc.

CONSENSUS PLANNING, INC.
Planning / Landscape Architecture
302 Eighth Street NW
Albuquerque, NM 87102
(505) 764-9801 Fax 842-5495
e-mail: cp@consensusplanning.com

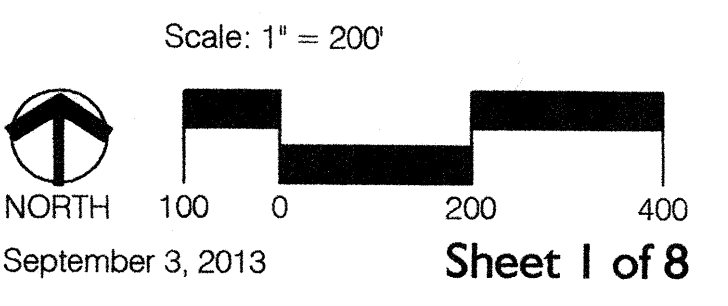

1006864

WATERSHED DESIGN STANDARDS

The purpose of these Design Standards is to provide a framework to assist the architects, landscape architects, and designers in understanding the vision and development goals for the property, which is anticipated to occur in phases. The primary goal for Watershed is to provide lifestyle choices for active adults and traditional, mixed-generation families within two, side-by-side communities that feature private parks, private open space, trails, and other amenities that are sensitive to and complement the adjacent Petroglyph National Monument.

These standards address the issues of landscape, setbacks, pedestrian amenities, screening, lighting, signage, and architecture that will create the visual image desired for Watershed. These Design Standards are intended to supplement, but not replace, the Westland Master Plan Design Guidelines. Future subdivision plats and development shall be consistent with this Site Plan for Subdivision and Design Standards, Westland Master Plan, and the Northwest Mesa Escarpment Plan. Minor amendments to this Site Plan for Subdivision shall be approved administratively by the Planning Director in accordance with the Comprehensive City Zoning Code and major amendments shall be approved by the Environmental Planning Commission (EPC).

1. APPROVAL PROCESS

A. The first tract to develop adjacent to the Petroglyph National Monument shall return to the EPC for review of the Site Development Plan for Subdivision. At that time, the EPC can choose to delegate future site development plans for subdivision to administrative review or to retain its approval authority and review a subsequent submittal. Administrative review would consist of the Planning Director or her/his designee, and an EPC staff planner, performing a design review analysis with each site development plan for subdivision for the proposed tracts to ensure compliance with applicable rules, regulations, standards, and policies prior to submittal to the DRB.

B. The applicant shall consult with the National Park Service and Parks and Recreation prior to approval of development adjacent to the Petroglyph National Monument.

2. DENSITY and MINIMUM LOT AREA

A. Pursuant to the Westland Master Plan and Western Albuquerque Land Holdings Sector Development Plan, the overall gross density of the Watershed development shall be limited to 4 dwelling units per acre.

B. Pursuant to the Westland Master Plan, the minimum lot area shall be 3,200 square feet per dwelling unit and the minimum lot width shall be 32 feet for properties zoned SU-2 for PDA that will be developed with houses.

3. PARKING and PARKING LOT STANDARDS

Parking at Watershed is primarily for single family residential development, however, the private clubhouse will include parking areas. The goal is to provide enough, but not excessive, amounts of parking so that the development does not become dominated by parking. All single family residential homes will include a garage.

A. Off-street parking for single family residential development shall be provided at the following rate:

- 2 spaces per 2 bedroom dwelling unit
- 3 spaces per 3-4 bedroom dwelling unit
- 4 parking spaces per 5 bedrooms or greater dwelling unit
- 3 spaces for rear-loaded 3-4 bedroom dwelling unit, of which 1 parking space can be met on-street

B. The minimum number of parking spaces for the private clubhouse (the only non-residential use allowed) shall be a minimum of 75, which based on a 12,000 square foot building and outdoor recreational amenities (e.g., tennis, pickleball, bocce, event lawn, etc.).

C. The number and design of handicapped spaces, motorcycle spaces, and bicycle spaces at the private clubhouse shall be based on the final number of parking spaces provided and in accordance with the City Zoning Code, Section 14-16-3-1 Off-Street Parking Regulations.

4. UTILITIES and SCREENING

To ensure the overall aesthetic quality of the property, the visual impact of utilities and equipment shall be minimized by the following:

A. On-site utilities, including electrical, telephone, and communication wires and equipment shall be installed and maintained underground.

B. Transformers, utility pads, cable TV, and telephone boxes shall be located out of view from public rights-of-way or visually screened with vegetation, fences, or walls. Screening shall be designed to allow for access to utility facilities. All screening and vegetation surrounding ground-mounted transformers and utility pads are to allow 10 feet of clearance in front of the equipment door and 5-6 feet of clearance on the remaining three sides for safe operation, maintenance, and repair purposes. Refer to PNM Electric Service Guide at www.pnm.com for specifications.

B. Developers shall contact PNM's New Service Delivery Department to coordinate electric service to avoid potential delays in meeting in-service target dates. Any existing or proposed public utility easements shall be indicated on subsequent Site Plan utility sheets. PNM's standard for electric distribution public utility easements is 10 feet in order to ensure adequate and safe clearances.

C. When an above-ground backflow prevention device is required by the City of Albuquerque, the heated enclosure shall be constructed of materials compatible with the architectural materials used as the main elements of the building. If pre-fabricated fiberglass enclosures are used, they shall be appropriately screened from view by walls and/or landscaping.

D. Alleys and interior parking courts may be used for dry utilities and sewer, wherever practical.

E. All roof-mounted equipment shall be screened from public view by materials of the same nature as the basic materials of the building.

F. Freestanding cellular antenna and cell towers shall be discouraged. Antennas shall be integrated with buildings, light poles, existing utility structures and other public facilities.

5. SIGNAGE

The signage standards were developed to regulate the size, location, type, and quality of sign elements within the Watershed development. The goal is to provide a wayfinding system throughout Watershed that maintains a consistent style, creates a sense of arrival, and complements the visual character of the property. A specific signage design program shall be approved by the Planning Director, concurrently with the review of each future subdivision.

A. All signs shall be in compliance with Section 14-16-3-5 General Sign Regulations of the Comprehensive City Zoning Code and the Westland Master Plan Design Guidelines. Pursuant to the SU-2 for PDA zone, the general principles guiding signage within the SU-2 for PDA zone should follow C-1 sign controls or as determined by an approved site development plan, which is satisfied by this Site Plan for Subdivision.

B. The primary Watershed community entry sign (Sign A) shall be part of a larger wall / landscape entry, and shall identify the project with wall-mounted lettering. Active adult residential signs, neighborhood signs, facility signs (i.e., private parks, trails, trailheads), and directional signs (Signs B, C, and D) shall be monument-style.

C. All signs shall have a stone or stucco base and columns, the sign face shall be stucco, metal, or cast in place concrete, and shall be lighted with fixtures that meet night sky requirements and illuminate the lettering on the sign only.

D. Entry monument signs for Watershed and each subdivision shall be placed on both sides of the entry road, where practical.

E. Directional signs shall be provided within the private roadway easements in Tracts A, B, and F.

F. Signage within the NWMEP Impact Area cannot exceed 6 square feet of sign face area.

G. Landscaping and signage shall not interfere with clear sight requirements. All signs, walls, trees, and shrubs between 3 and 8 feet tall (as measured from the gutter pan) shall not be acceptable in this area.

H. Free-standing signs shall not require any external bracing, angle-iron supports, guy wires or similar devices. No signage is allowed that uses moving parts, makes audible sounds, or has blinking or flashing lights. Off-premise signs, signs with reader boards, and electronic signs are prohibited.

I. Building-mounted signs shall not be permitted.

J. Signs shall not overhang into the public right-of-way or extend above the building roof line.

K. ILLUSTRATIVE SIGNAGE LOCATIONS. The following illustrations provide the location and size standards for the sign program at Watershed.

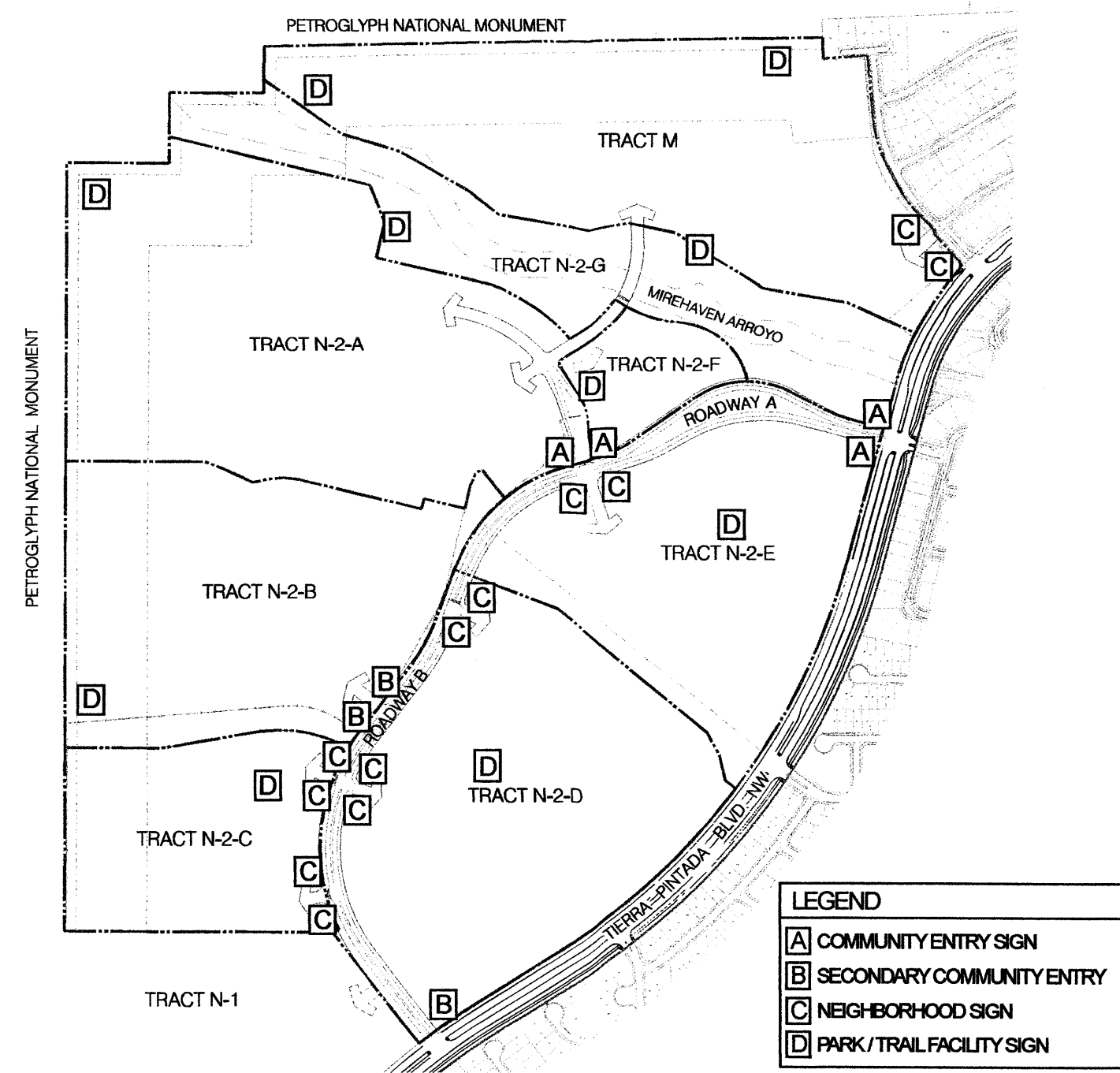

L. ILLUSTRATIVE COMMUNITY ENTRY WALL / SIGN - A



M. ILLUSTRATIVE SECONDARY COMMUNITY ENTRY - B
Max. Height: 6 feet. Max. Length: 12 feet. Max. Sign face: 35 SF.

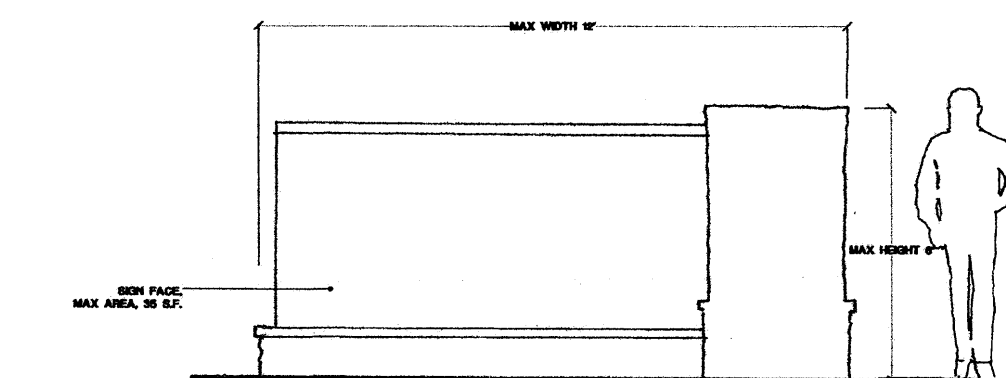

N. ILLUSTRATIVE RESIDENTIAL NEIGHBORHOOD SIGN - C
Max. Height: 5 feet. Max. Length: 8 feet. Max. Sign face: 18 SF

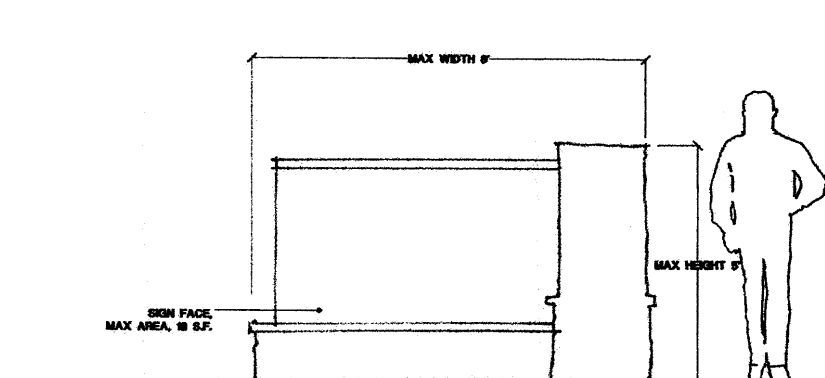

O. ILLUSTRATIVE FACILITIES SIGN - D
(within NWMEP Impact Area)
Max. Height: 3.5 feet. Max. Length: 5 feet. Max. Sign face: 6 SF

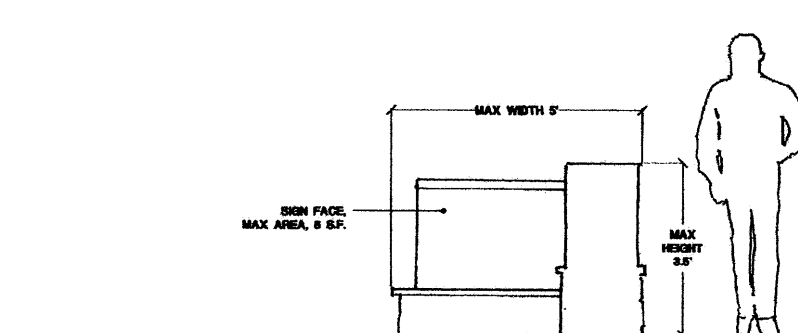

P. ILLUSTRATIVE FACILITIES SIGN - D
Max. Height: 4 feet. Max. Length: 6 feet. Max. Sign face: 12 SF

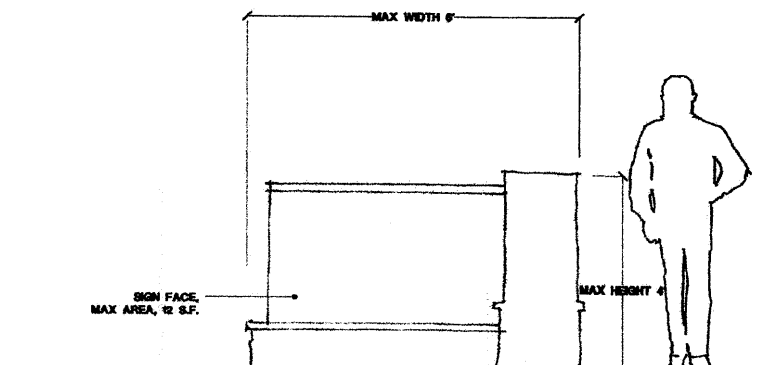

6. WALLS / FENCES

The intent of the wall and fence program for Watershed is to minimize their visual impact through landscaping, meandering within a landscape area, providing openings, and view fence, where appropriate.

- A. Walls and fences shall comply with City Comprehensive Zoning Code, Section 14-16-3-19, General Height and Design Regulations for Walls, Fences, and Retaining Walls and as specified below.
- B. Landscape provided along walls shall comply with the regulations contained in City Comprehensive Zoning Code, Section 14-16-3-19 (B) (2) (b) e.
- C. View fence (tubular steel) shall be provided in areas adjoining private parks, the Petroglyph National Monument, and the Mirehavan Arroyo. The maximum height of the view fence shall be 6 feet (see illustrations below).
- D. The perimeter wall shall be a combination of walls, view fence, and open fencing. Acceptable materials include CMU block, tubular steel, and other materials pursuant to the City Comprehensive Zoning Code.

E. Perimeter fences and/or walls shall include pedestrian openings (may be gated) at key locations within the development to ensure convenient access to other areas within the property.

F. Yard walls shall be finished to match adjoining exterior house walls, where applicable. Walls shall not exceed 6 feet in height except at the gate opening.

G. No pedestrian or vehicular access gates or openings from private residences directly into the Petroglyph National Monument shall be allowed.

H. Pursuant to the Northwest Mesa Escarpment Plan (NWMEP), stucco wall colors within the Impact Area shall be limited to yellow ochres, browns, dull reds, and grey-greens existing on the mesa and escarpment, exclusive of the basal. The reflectance of the approved colors ranges between 14 percent and 63 percent of the light which falls on them. This middle range of reflectance is intended to avoid very light and very dark colors. A chart of the approved colors is available for review at the City Planning Department.

I. Rear and side yard view fence/walls facing the Petroglyph National Monument shall be staggered by 3 feet horizontally for every two lots.

J. Development at the edge of public or private open space shall be designed to complement and enhance the open space. Where the adjacent land use requires visual privacy, non-continuous, non-perimeter walls may be constructed. Varied setbacks and landscaping are required.

K. Unfinished block walls and barbed wire, chain link, concertina wire, wood picket, and plastic/vinyl fencing are prohibited.

L. ILLUSTRATIVE WALL ELEVATION

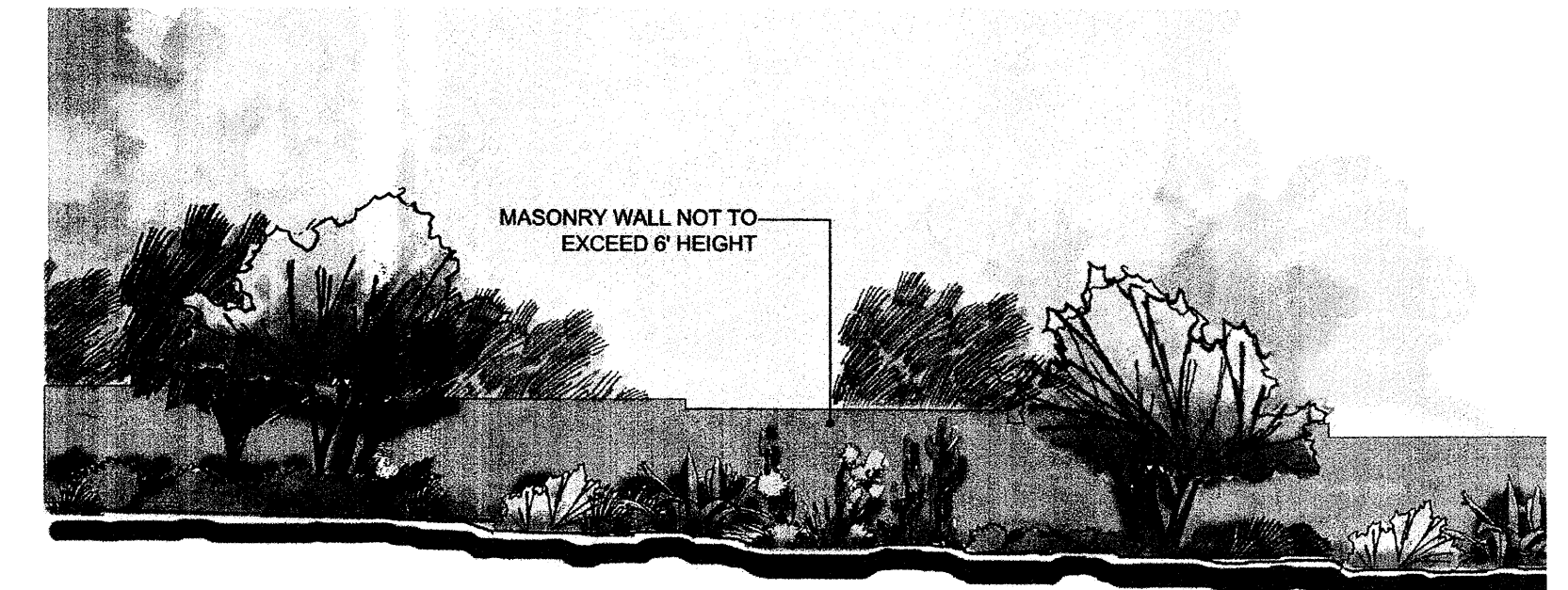

M. ILLUSTRATIVE VIEW FENCE (PERIMETER FENCE) ADJACENT TO PRIVATE PARKS, PETROGLYPH NATIONAL MONUMENT, MIREHAVEN ARROYO

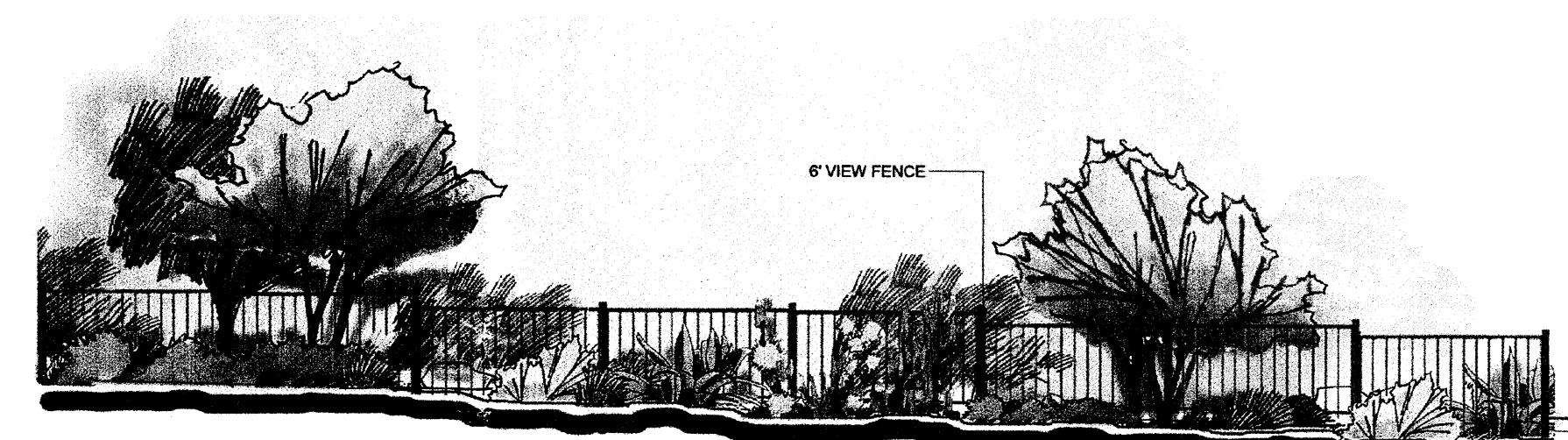

N. ILLUSTRATIVE VIEW FENCE WITH MASONRY BASE ADJACENT TO PRIVATE PARKS, PETROGLYPH NATIONAL MONUMENT, MIREHAVEN ARROYO

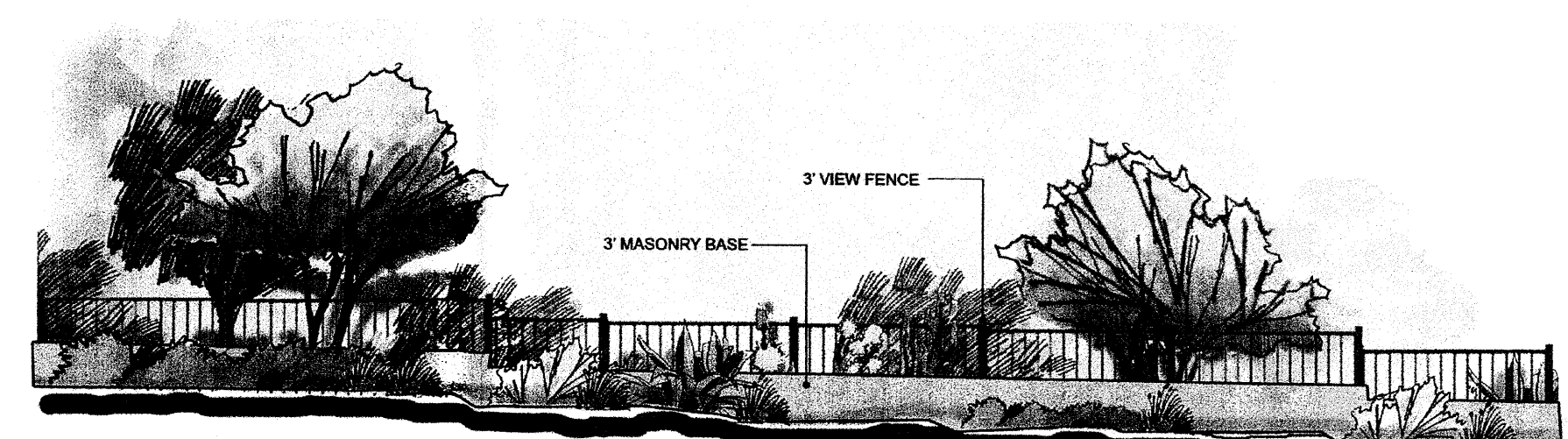

WATERSHED @ ESTRELLA

SITE PLAN FOR SUBDIVISION

Prepared For:

Pulte Group

August 30, 2013

Prepared By:

SEC Planning, LLC
Consensus Planning, Inc.
Bohannon Huston, Inc.
Sheet 2 of 8

7. SIDEWALKS, TRAILS, and PEDESTRIAN CROSSINGS

Sidewalks and trails at Watershed are intended to lessen the need for vehicular use and provide connectivity to create a pedestrian-oriented community. Individual development phases should ensure off-road pedestrian and bicycle access to the various park facilities, Petroglyph National Monument, and the Mirehaven Arroyo, as applicable.

- A. All sidewalks and ramps within public rights-of-way shall meet City standards and be designed to be handicapped accessible (see Americans with Disabilities Act Criteria for Barrier-Free Design), except where topography makes this unfeasible.
- B. Sidewalks on local residential streets shall be a minimum of 4 feet in width. Sidewalks along collectors or major local streets shall be a minimum of 6 feet in width. Where sidewalks are planned on one side only of the collector or major local street, that sidewalk shall be a minimum of 8 feet in width (Roadways A and B), and shall require a sidewalk design variance request to the DRB.
- C. Trails shall be designed for multi-use and accommodate pedestrians, runners, and bicyclists, except the perimeter trail shall prohibit bicycles due to soil conditions and erosion potential. Connections shall be made from individual neighborhoods to the community trail system via trails and/or sidewalks as determined in the subdivision phase.
- D. Trails shall use Barrier-Free Design to accommodate physically challenged individuals as trail users, where feasible.
- E. All private trails shall be concrete, asphalt, or stabilized crusher fines and have a minimum width of 8 feet.
- F. Pedestrian crossings shall be clearly demarcated with colored, textured paving where they cross vehicular entrances and streets.

G. ILLUSTRATIVE PEDESTRIAN CIRCULATION

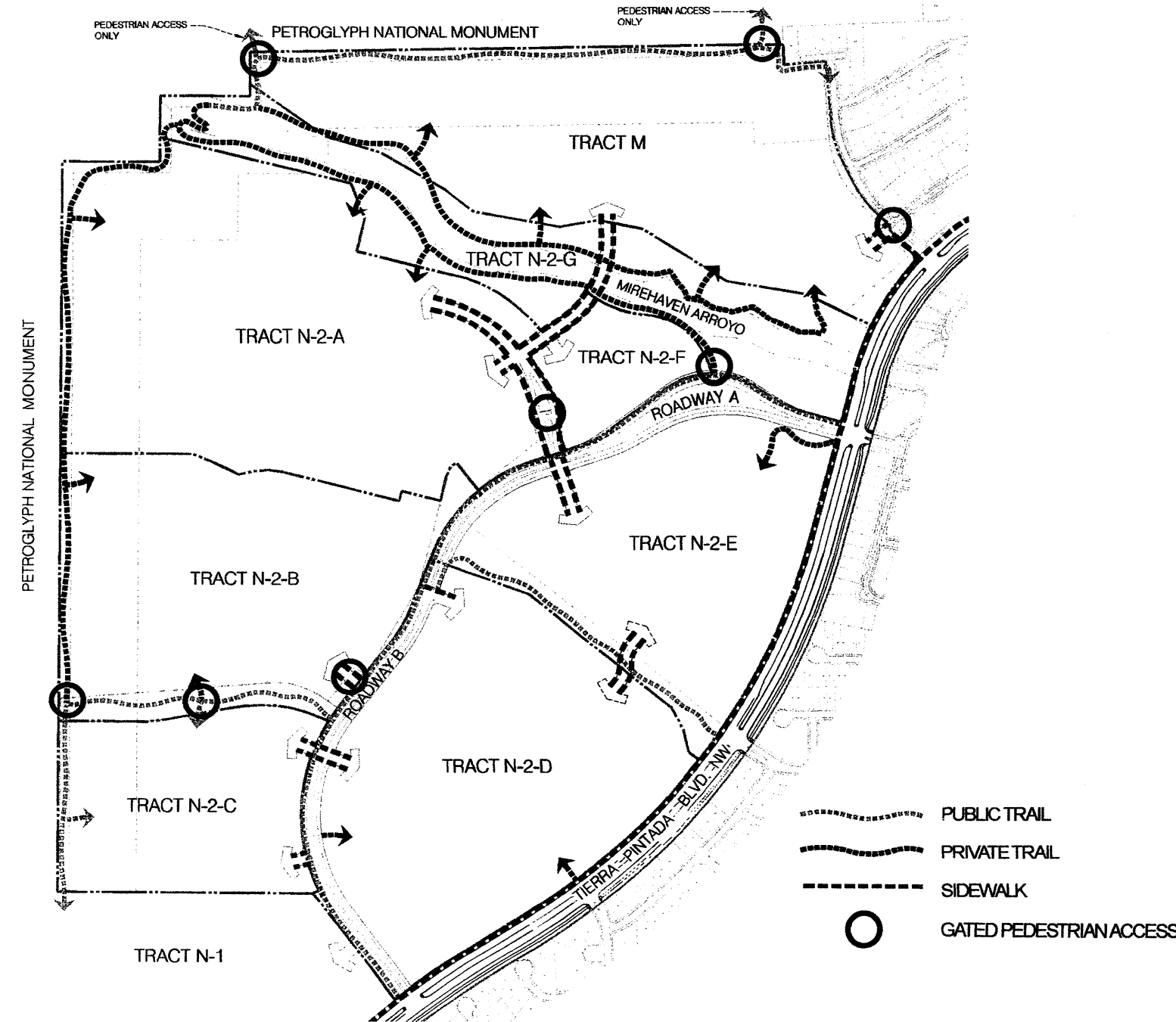

8. PRIVATE PARKS and COMMON AREAS

A defining feature of Watershed are the common areas along the Petroglyph National Monument, Mirehaven Arroyo, and private pocket parks that are spread throughout Watershed, within the active adult areas and the traditional, mixed generation areas.

GENERAL

- A. Where private parks or private open space are adjacent to the Mirehaven Arroyo or other drainageways, natural landscaping elements shall be provided to guide or restrict access, where appropriate.
- B. Where houses are adjacent to the Mirehaven Arroyo or other drainageways, the boundary between the house and the Arroyo / drainageway shall be treated similarly to houses abutting the Petroglyph National Monument as specified in the Walls and Fences section.

PRIVATE PARKS

- C. Private pocket parks shall be provided throughout the Watershed community. Each pocket park shall include turf grass, deciduous and evergreen trees, shrubs, and groundcovers; and benches, shade structures, and pedestrian pathways. Children's play areas shall also be provided in the traditional, mixed generation neighborhood, private pocket parks.
- D. Private pocket parks shall be provided throughout Watershed and shall be built and maintained by the Homeowners' Association.
- E. Tract F (see Sheet 1) shall contain a larger private park facility and private clubhouse, both to be built and maintained by the Homeowners' Association.

F. ILLUSTRATIVE POCKET PARK

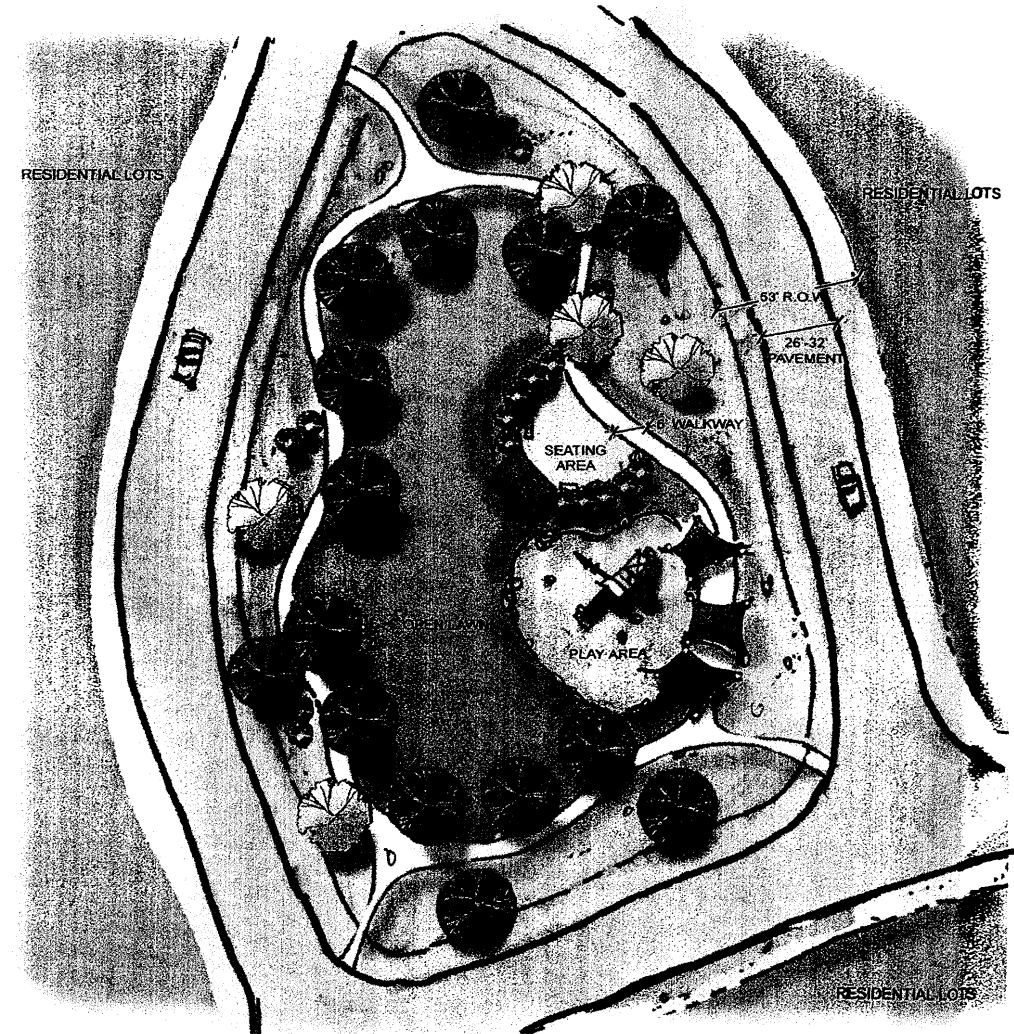

F. In addition to private pocket parks, the drainageways that run through the project shall be developed as private linear parks that convey stormwater, serve as a recreational amenity for Watershed residents, and are open to the public. The linear park section (see Section and Plan View below) shall be a minimum of 70 feet in width, and include landscape on both sides of the arroyo and a meandering 10-foot trail. The private linear parks shall be built and maintained by the Homeowners' Association.

G. LINEAR PARK - Illustrative Section and Plan View

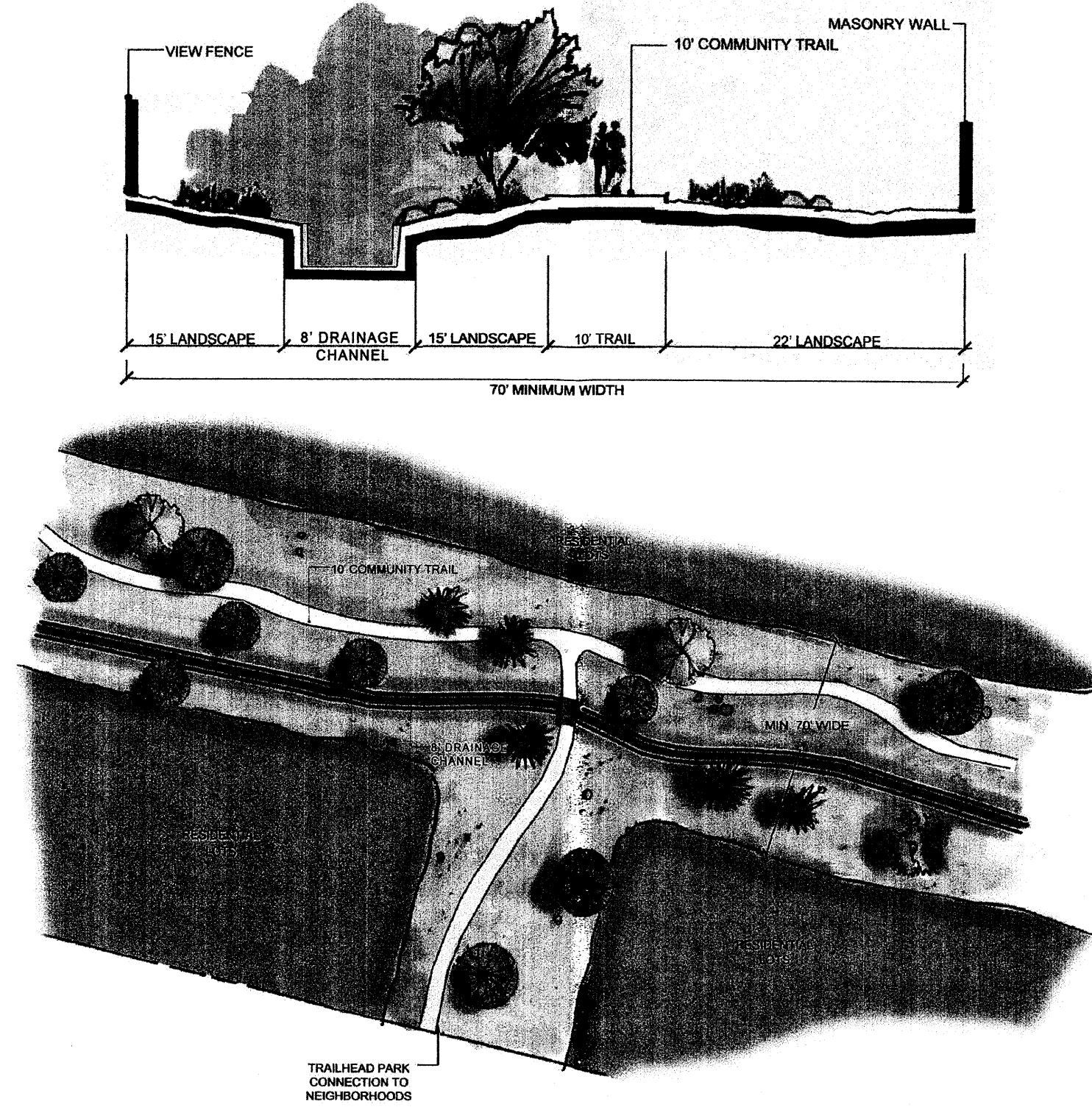

9. MIREHAVEN ARROYO

The Mirehaven Arroyo is a significant drainage feature that is designated by the Facility Plan for Arroyos as an Urban Recreational Arroyo. The intent is to treat the Mirehaven Arroyo as an important element of the private open space area within Watershed and to provide visual relief from development.

- A. Mirehaven Arroyo shall be preserved in a naturalized state and shall require bank stabilization, in accordance with Section 14, Drainage on Sheet 6.
- B. Treatment for the Mirehaven Arroyo shall be in coordination with and to the satisfaction of the City of Albuquerque.
- C. The buffer between the channel edge of the Mirehaven Arroyo and the development area of Watershed shall be a minimum of 50 feet in width and shall contain trails with a minimum width of 8 feet.
- D. Access to the Mirehaven Arroyo shall be restricted to the residents of the active adult community.

E. MIREHAVEN ARROYO - Illustrative Section and Plan View

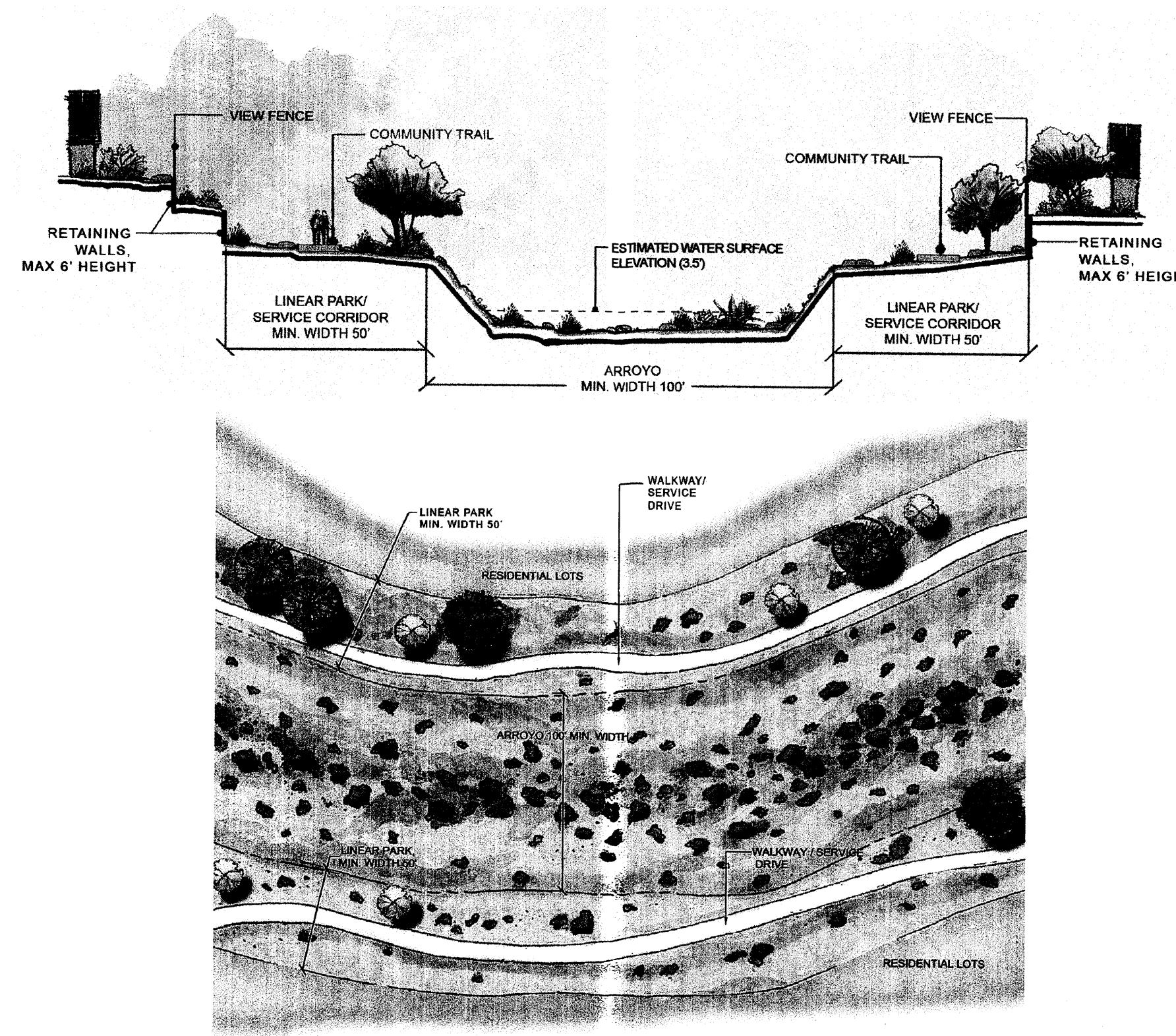

10. PETROGLYPH NATIONAL MONUMENT

The edge treatment adjacent to the Petroglyph National Monument is intended to minimize the development impact to the Monument and to provide for visual surveillance into the Monument.

- A. A primarily single-loaded local street shall run along the shared edge with the Petroglyph National Monument. There shall be a minimum 25 to 50 foot buffer between the Monument edge and the local street or residential lots. With regard to the buffer proposed along the common boundary between the project and the Monument, no more than 30% of the linear footage of this buffer shall be permitted to encroach into the 50 foot buffer, and in no case shall the buffer be less than a minimum width of 25 feet.
- B. Residential lots shall not abut more than 30% (approximately 23 lots) of the Monument edge.
- C. The typical section for the Monument edge will include a 10-foot meandering trail within a naturalized landscape area adjacent to the Monument and a single-loaded 26 to 32-foot paved roadway (see Section and Plan View below).
- D. The location of access points into the Monument shall be coordinated with and contingent upon approval from the National Park Service.
- E. A trail feasibility study shall be required prior to development of Tract A for the northern perimeter trail for public access to the Petroglyph National Monument and submitted to the Planning Director, City Park and Recreation Department/Open Space Division, and Petroglyph National Monument for review. The study shall consider existing soils, grade, slope, and parking. If it is determined by the Planning Director that this trail is not feasible, the applicant shall not be required or allowed to construct the trail or access to the Petroglyph National Monument.

F. PETROGLYPH NATIONAL MONUMENT EDGE TREATMENT - Illustrative Sections (top - single-loaded; bottom - double-loaded) and Plan View

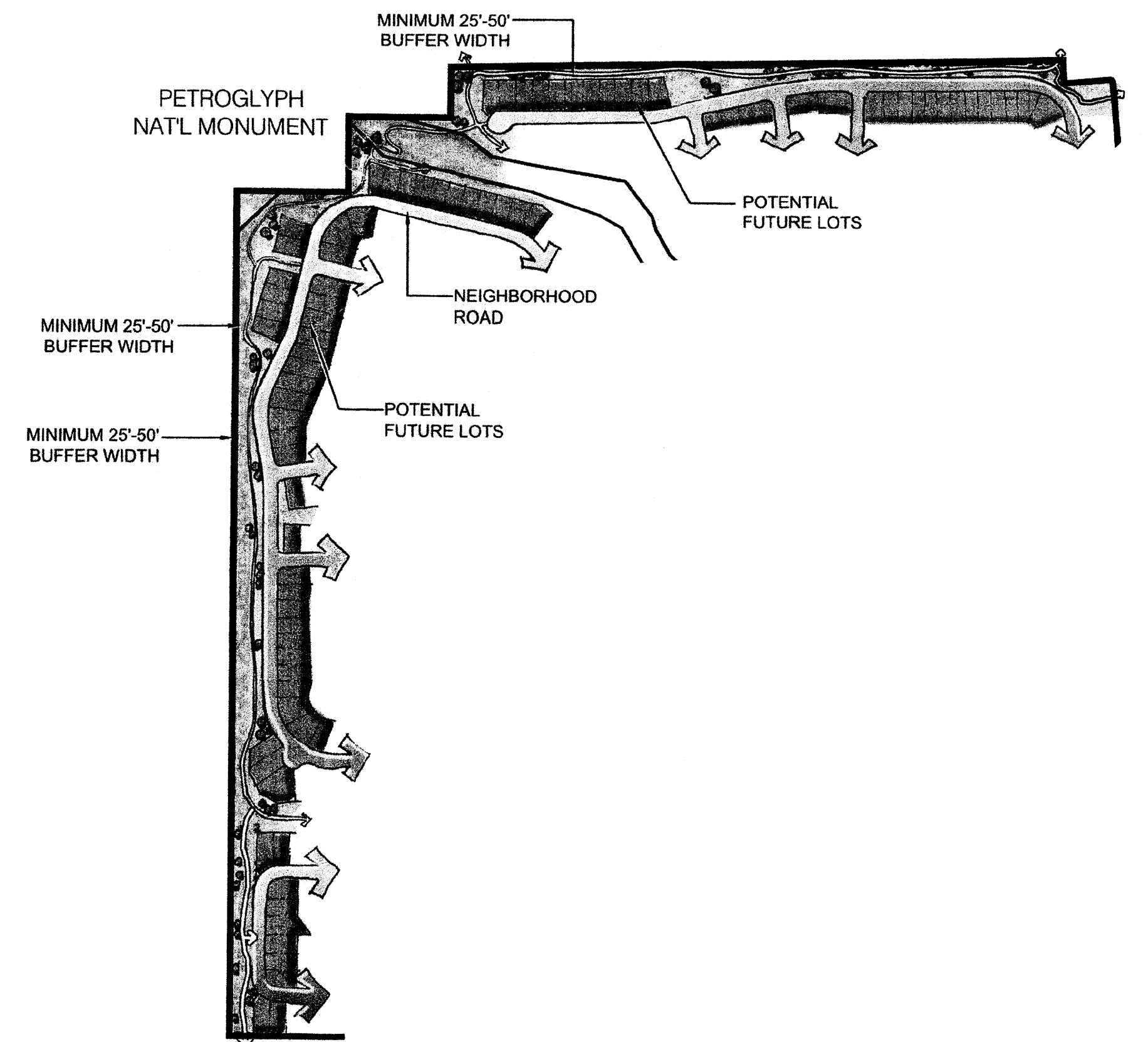
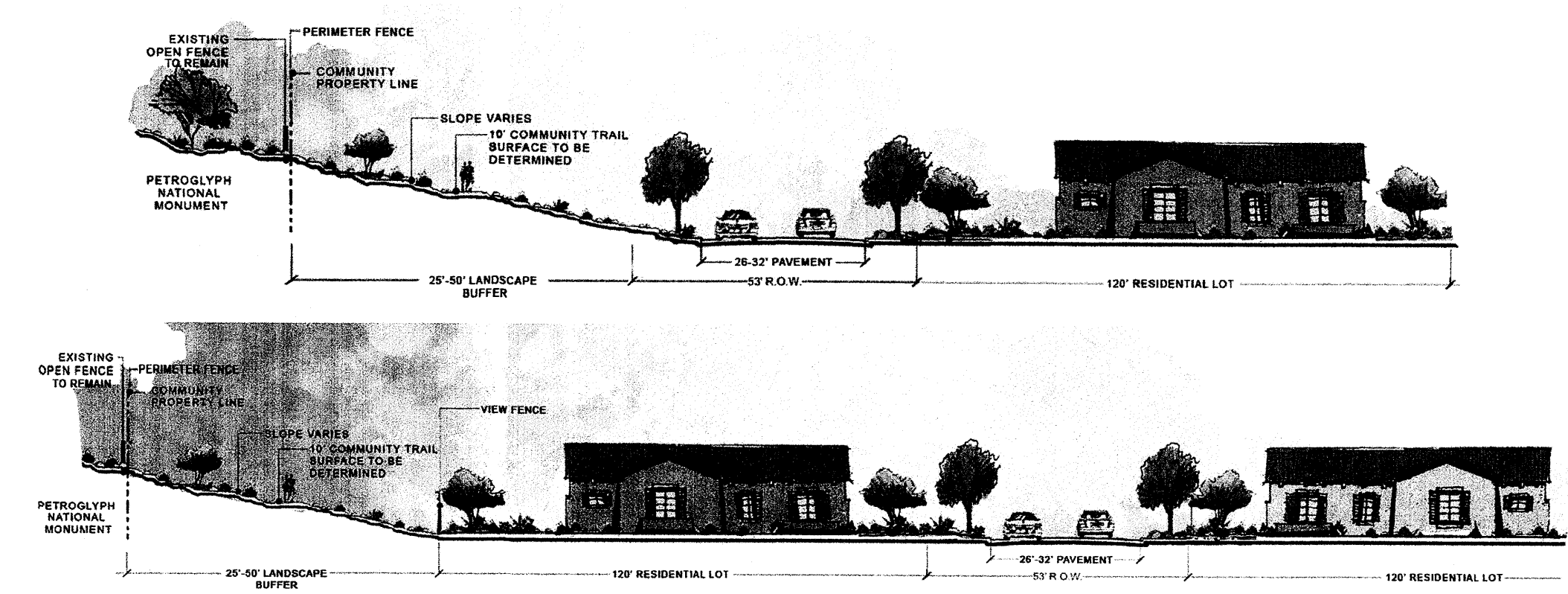

WATERSHED @ ESTRELLA
SITE PLAN FOR SUBDIVISION

Prepared For:

Pulte Group

September 11, 2013

Prepared By:

SEC Planning, LLC
Consensus Planning, Inc.
Bohannon Huston, Inc.
Sheet 3 of 8

11. STREETS and STREETSCAPES

The design of streets within Watershed are intended to serve multi-modal transportation systems. Vehicular travel lanes, sidewalks and/or trails, and bicycle lanes will be provided within all major streets as shown below in the street sections.

- A. Streets within Tracts C, D, and E shall be public and streets within Tracts A, B, and F shall be private and maintained by the Homeowners' Association.
- B. Public streets within Watershed shall meet the City's Development Process Manual (DPM) standards, except as noted below. Any necessary variances shall go through the standard variance process.
- C. All streets within Watershed shall comply with the DPM's Single Access Criteria.
- D. Where possible, street design shall maximize water harvesting for landscaping.
- E. Major Local Street A is the primary entry off Tierra Pintada Boulevard and includes a large landscaped median with significant slope. The section will include a 20-foot paved roadway surface in each direction, with 14 feet of travel lane and 6 feet of bicycle lane (see section - 11.J).
- F. Major Local Street B is a continuation of the same roadway, but the right-of-way is 92 feet in width. The section includes an 8-foot landscaped median, 15-foot landscaped area, 14-foot trail lanes, and a 6-foot bicycle lane. Sloped areas will include retaining walls in accordance with City regulations (see section - 11.K).
- G. A sidewalk design variance request to the Development Review Board (DRB) shall be required to allow for the single 8-foot wide meandering sidewalk on Roadways A and B.
- H. A design variance request to the DRB shall be required to allow for the 8-foot wide median in Roadway B.
- I. A landscape maintenance agreement with the City of Albuquerque shall be required for Tierra Pintada (west side) and Roadways A and B. Coordination between Watershed and Stormcloud (to the east) neighborhoods shall be required to provide consistency with design and maintenance of the streetscapes and medians. All landscaping along streets and medians are to be maintained by the Homeowners' Association.
- J. ROADWAY A (MAJOR LOCAL STREET) - Illustrative Section and Plan Views

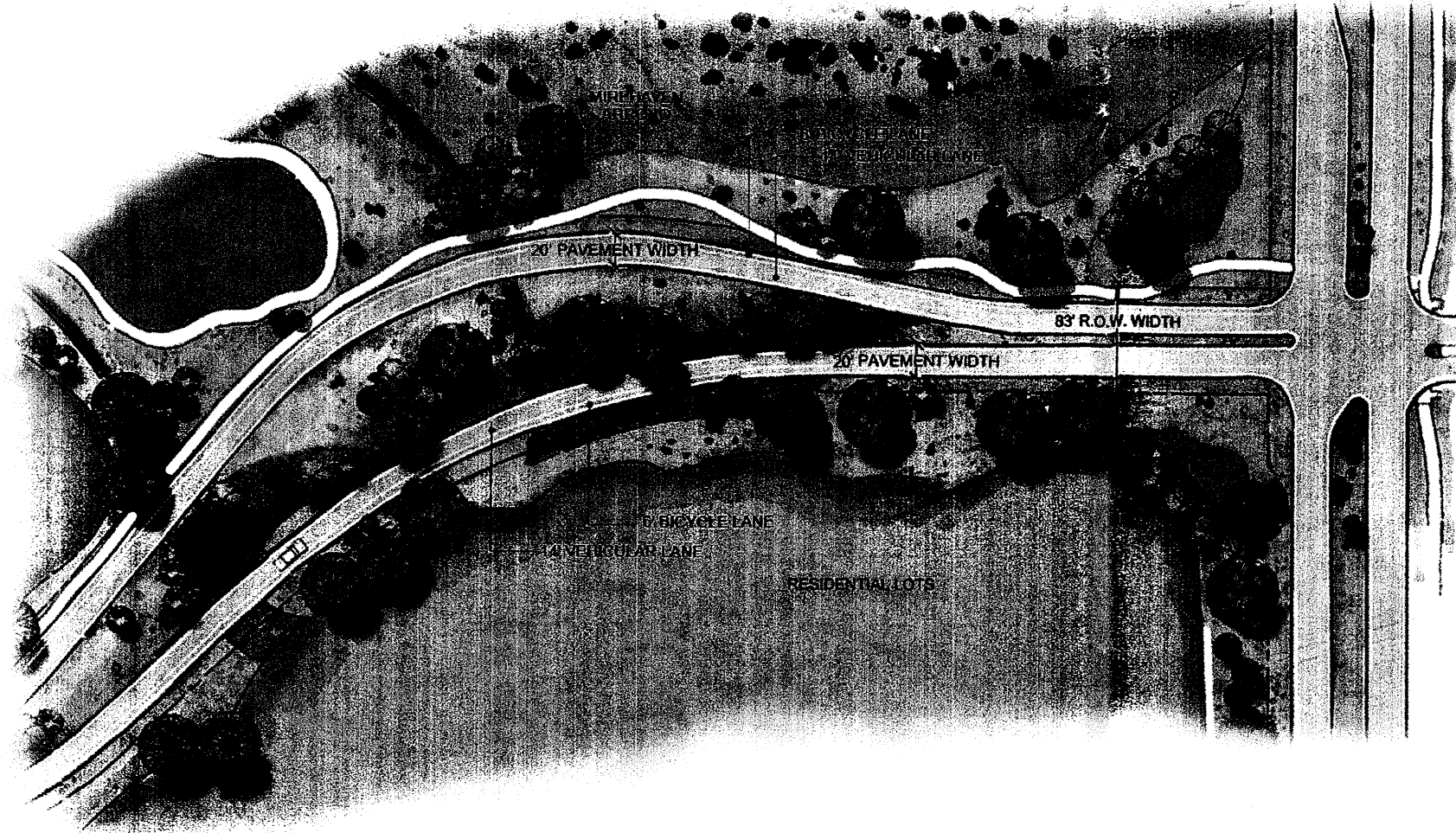
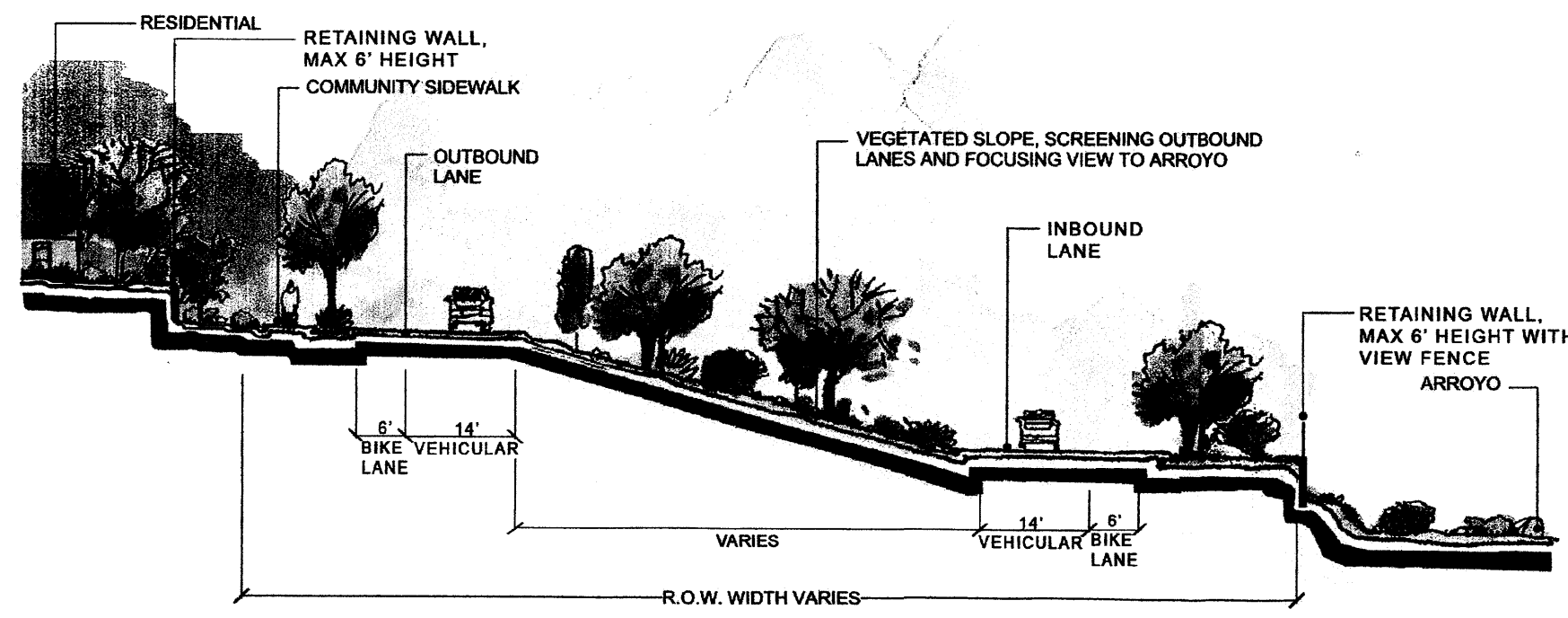

K. ROADWAY B (MAJOR LOCAL STREET) - Illustrative Section and Plan Views

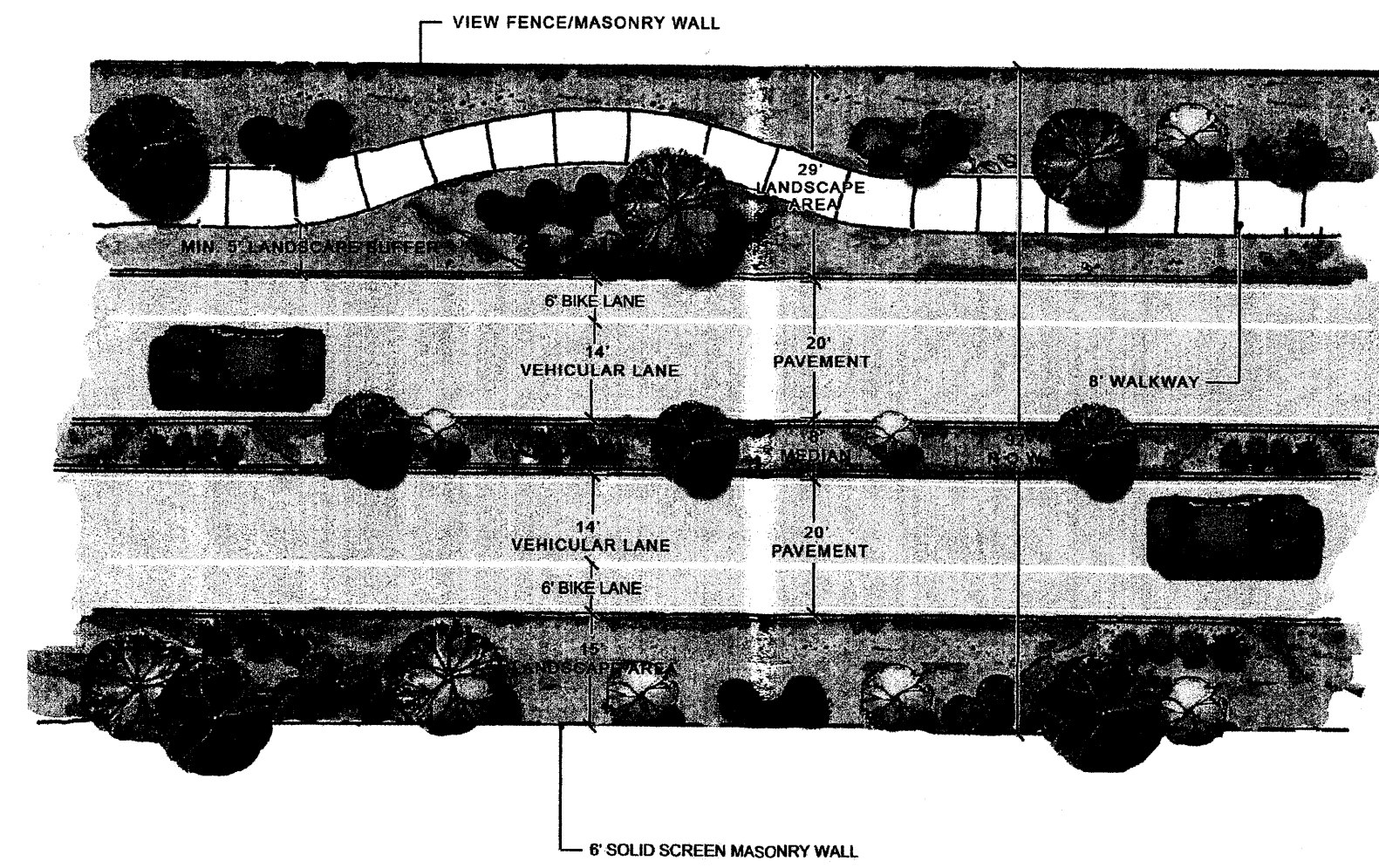
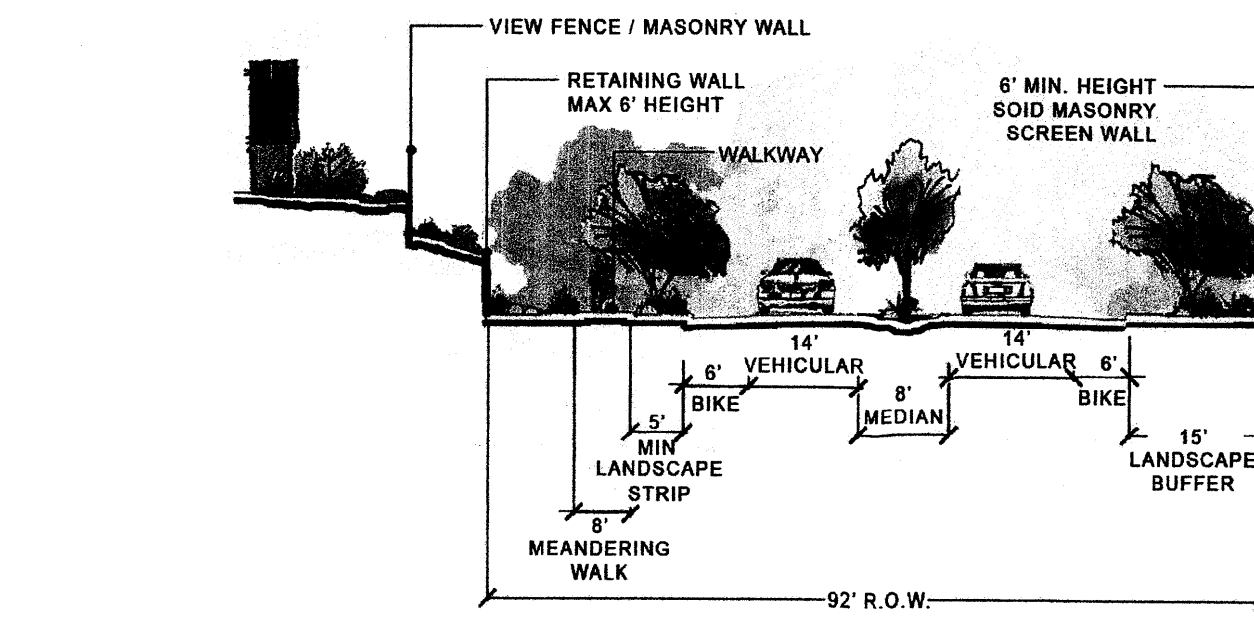

L. The roadway section for Tierra Pintada includes a landscaped median, an existing 10-foot wide trail on the east side and an existing 6-foot wide sidewalk on the west side. Landscaped parkways and buffers shall be provided on both sides of the roadway.

M. TIERRA PINTADA BOULEVARD - Illustrative Section and Plan Views

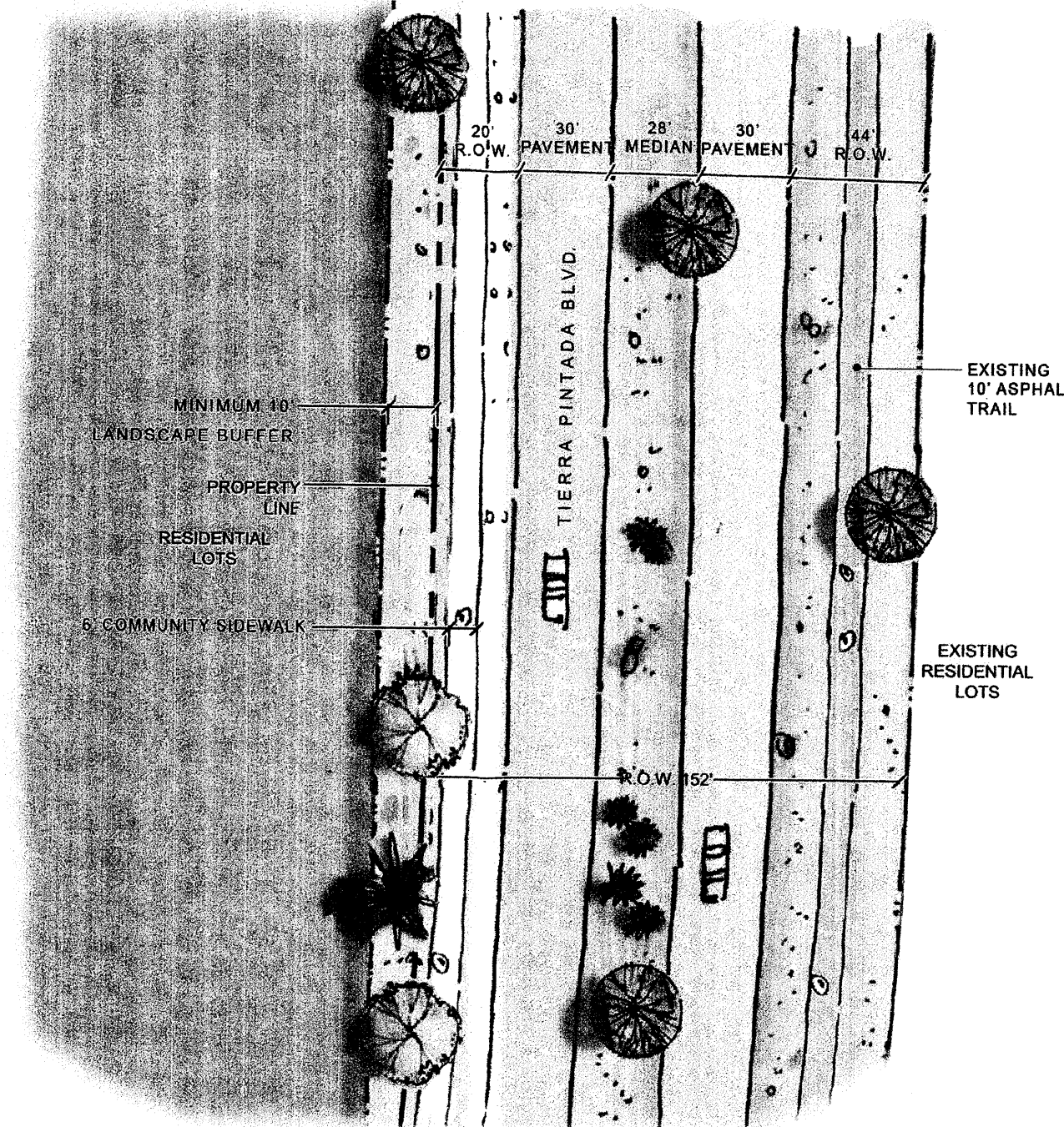
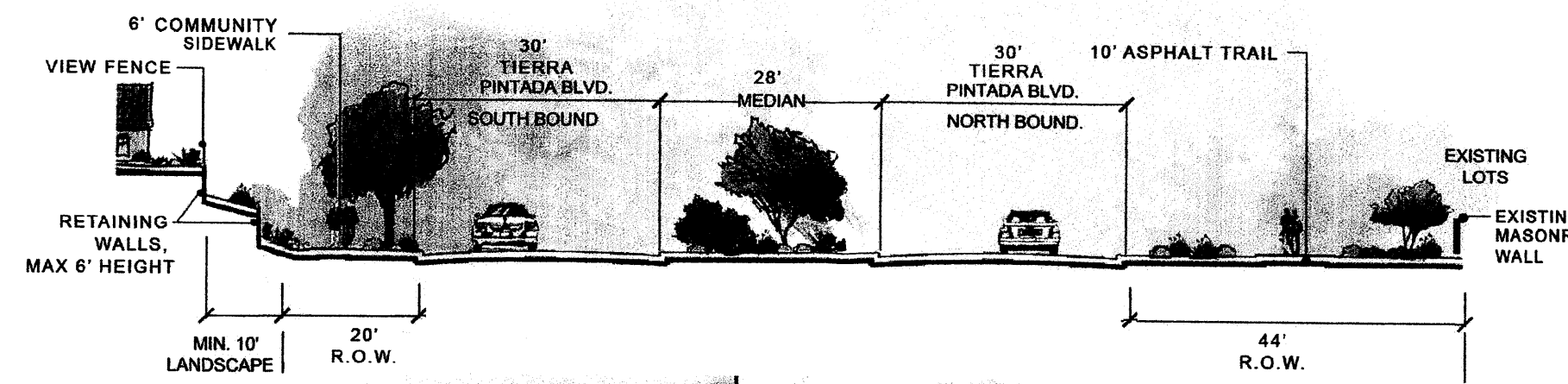

N. The majority of streets within Watershed shall be private local residential streets. The street section shall include 26 to 32 feet of road surface, and 4-foot sidewalks and a landscaped parkway on both sides of the street.

O. LOCAL RESIDENTIAL STREET - Illustrative Section View

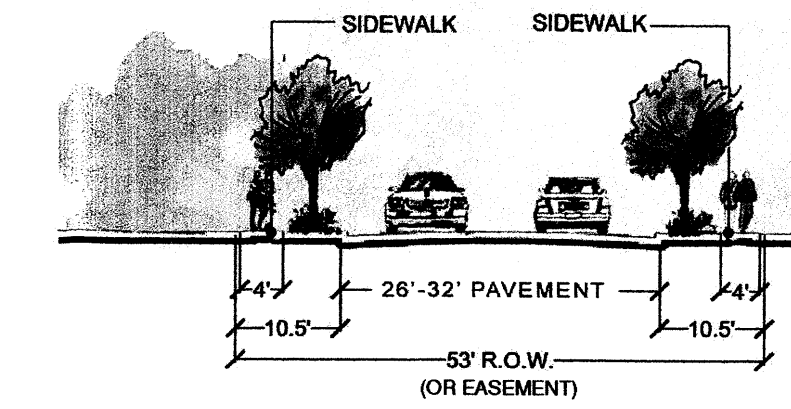

P. Pedestrian crosswalks shall be a minimum of 6 feet in width and constructed of colored textured paving.

Q. Coordination with City Traffic Operations shall be required for proposed crosswalks within City rights-of-way at any unsignalized intersections or mid-block crossings.

R. TYPICAL PEDESTRIAN CROSSWALK - Illustrative Plan View

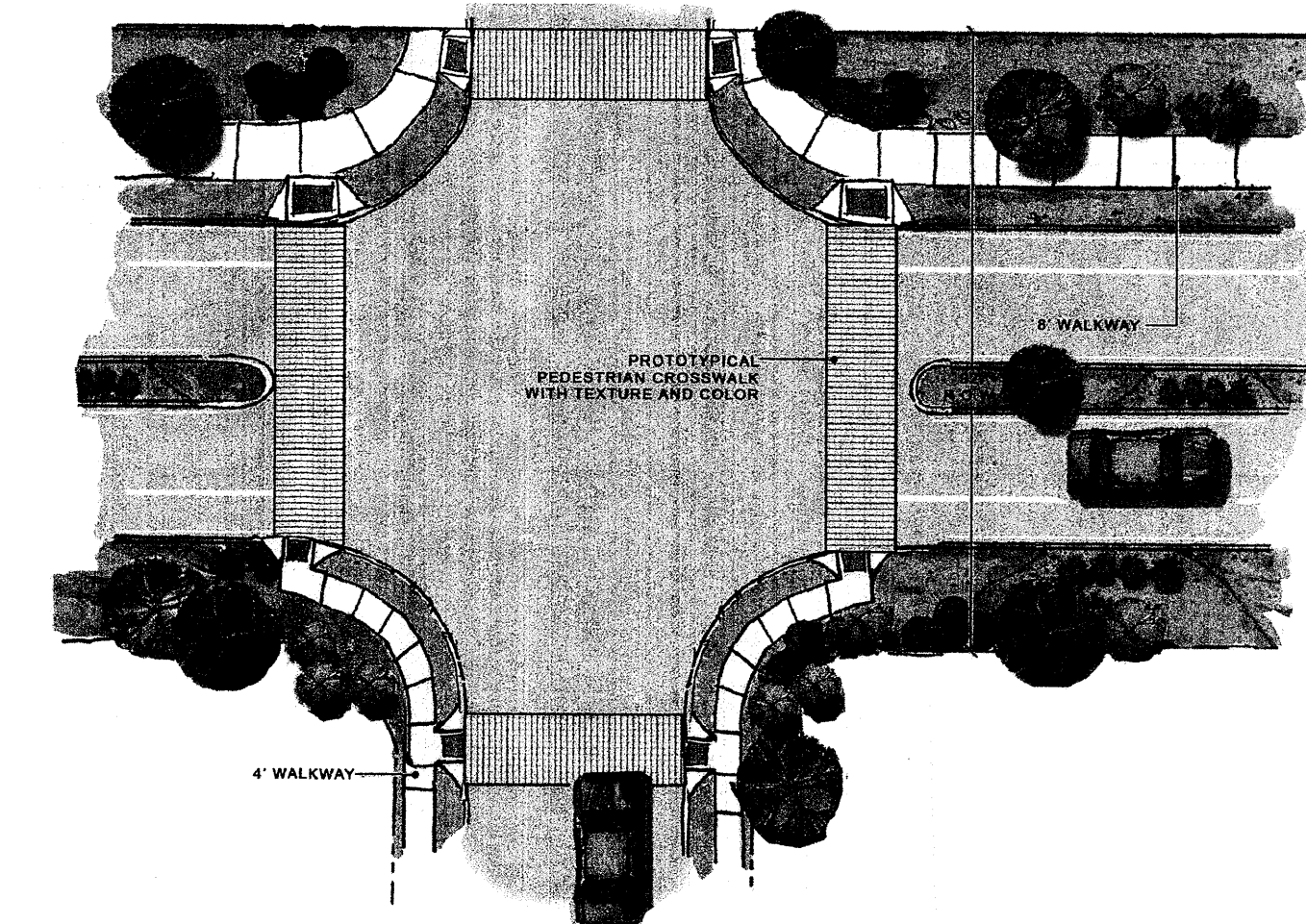

WATERSHED @ ESTRELLA

SITE PLAN FOR SUBDIVISION

Prepared For:

Pulte Group

August 30, 2013

Prepared By:

SEC Planning, LLC
Consensus Planning, Inc.
Bohannon Huston, Inc.
Sheet 4 of 8

12. ARCHITECTURE

This section is intended to convey the high quality of construction desired for Watershed. It applies to the residential units and the private clubhouse, unless explicitly stated otherwise.

Views and Maximum Building Height

The goal is to retain views, as much as feasible, by minimizing the visual impact of structures, enhancing the views from the structures, while still allowing for full development of the property.

- A. Pursuant to the Westland Master Plan Design Guidelines, though not required, buildings with flat roofs are encouraged because they will help preserve views in addition to being more Southwestern in style.
- B. Buildings located within the 350 foot Impact Area of the Northwest Mesa Escarpment Plan (NWMEP) shall be limited to a building height of 15 feet, in accordance with the Design Overlay Zone.
- C. Buildings located outside the 350 foot Impact Area of the NWMEP shall not exceed 2 stories and are limited to 26 feet in height (height as defined in the City Comprehensive Zoning Code), with the exception of the Private Clubhouse, which is limited by the 40-foot height restriction of the SU-2/PDA zone as provided for in the Westland Master Plan.

Casitas

- D. For residential structures with casitas, the casitas in the front yard shall not block the view to the main building entrance.

Front Porches

- E. Front porches, if used, shall have a minimum 6 foot depth.

Building Materials, Colors, and Reflectivity

- F. Stucco shall be the primary building material for both the residential units and the private clubhouse.
- G. Pursuant to the NWMEP, stucco colors within the Impact Area shall be limited to yellow ochres, browns, dull reds, and grey-greens existing on the mesa and escarpment, exclusive of the basalt. Mechanical devices, and roof vents shall also be consistent with approved colors. The reflectance of the approved colors ranges between 14 percent and 63 percent of the light which falls on them. This middle range of reflectance is intended to avoid very light and very dark colors. A chart of the approved colors is available for review at the City Planning Department.
- H. Stucco colors in areas outside of the NWMEP Impact Area (including residential units and the private clubhouse) shall be limited to warm, desert earth tones. Other colors may be used to accent architectural features, such as entry ways, window trim, fascias, and other traditional southwestern architectural features. Metallic and high intensity colors will not be permitted.
- I. Stone or brick can be used as accent materials on the residential units and the private clubhouse. Colors shall be limited to earth tone colors.
- J. Windows may be wood, metal, or solid vinyl. All windows visible from nearby streets and paths shall be glazed with clear, non-reflective glass. Reflective film is prohibited.
- K. Exterior doors, including garage doors, shall be stained or painted wood, or painted metal.

Roof Forms, Colors, and Materials

- L. Roofs may be flat, pitched, or combination of both and shall be made of non-reflective materials. Roof colors within the NWMEP Impact Area shall be limited to the approved colors as noted above.
- M. Allowable pitched roof materials include clay or concrete barrel tile, or architectural shingles. Metal roofs are not allowed.
- N. Dish antennae shall not be placed on roofs within the NWMEP Impact Area.

Articulation

- O. Residential structures shall provide articulation through massing, changes in height, accent materials, recessed glazing, and covered entries.

Private Clubhouse and Social Lawn

The private clubhouse is intended to be a landmark for the active adult community, and will contain a variety of amenities (e.g., fitness center, social gathering spaces, class and meeting rooms, staff offices, restrooms and lockers). The social lawn provides a variety of outdoor amenities for the residents of the active adult community (tennis, bocce, pickleball, hardscape, landscape, gathering areas for outdoor entertainment, etc.).

- P. The private clubhouse building shall contain 9,000 to 12,000 square feet of interior space, one story, and shall be no greater than the maximum building height allowed by the SU-2 PDA zone (40 foot maximum).
- Q. The architectural style shall be Contemporary Southwestern, as described below, and will include recessed windows and door openings, and heavy timber structures to create covered and shaded exterior spaces.

Architectural Style - Residential and Private Clubhouse

R. The following descriptions are intended to portray the architectural styles desired for the Watershed development. The use of a single architectural style within a neighborhood is discouraged. The intent is to offer a homebuyer a choice in architectural styles with a variety of one and two story units, pitched and flat roofs, rear and front loaded units.

- Contemporary Southwestern - This style is characterized by multiple, volumetric masses with clean, sharp lines; walls punctuated with small asymmetrical windows; and flat roofs (with varying parapet heights) or a combination of flat and pitched roofs. Windows are typically recessed and casement style, (awning and fixed). Covered, portal entries with stucco columns are typical of this style.
- Territorial - This style is characterized by multiple, volumetric, rectilinear forms; flat roofs with varying parapet heights that are straight and accented with brick coping, metal or wood canales; and windows that are divided into vertically proportioned rectangles. Windows and doors typically include white painted trim, with pediment or corniced header trim. Covered, portal entries with painted columns, lintels, and trim are typical of this style.
- Spanish Eclectic - This style is characterized by an L-shaped or rectangular footprint; one or two stories; with an asymmetrical front elevation and round or square towers as accents. Roofs are pitched with a low to medium slope (gable or hip) and are covered in clay or concrete barrel tile. Windows and doors can be recessed and accented with painted trim, lintels, and sills.

S. ILLUSTRATIVE - FRONT-LOADED, PITCHED ROOF, ONE-STORY UNITS

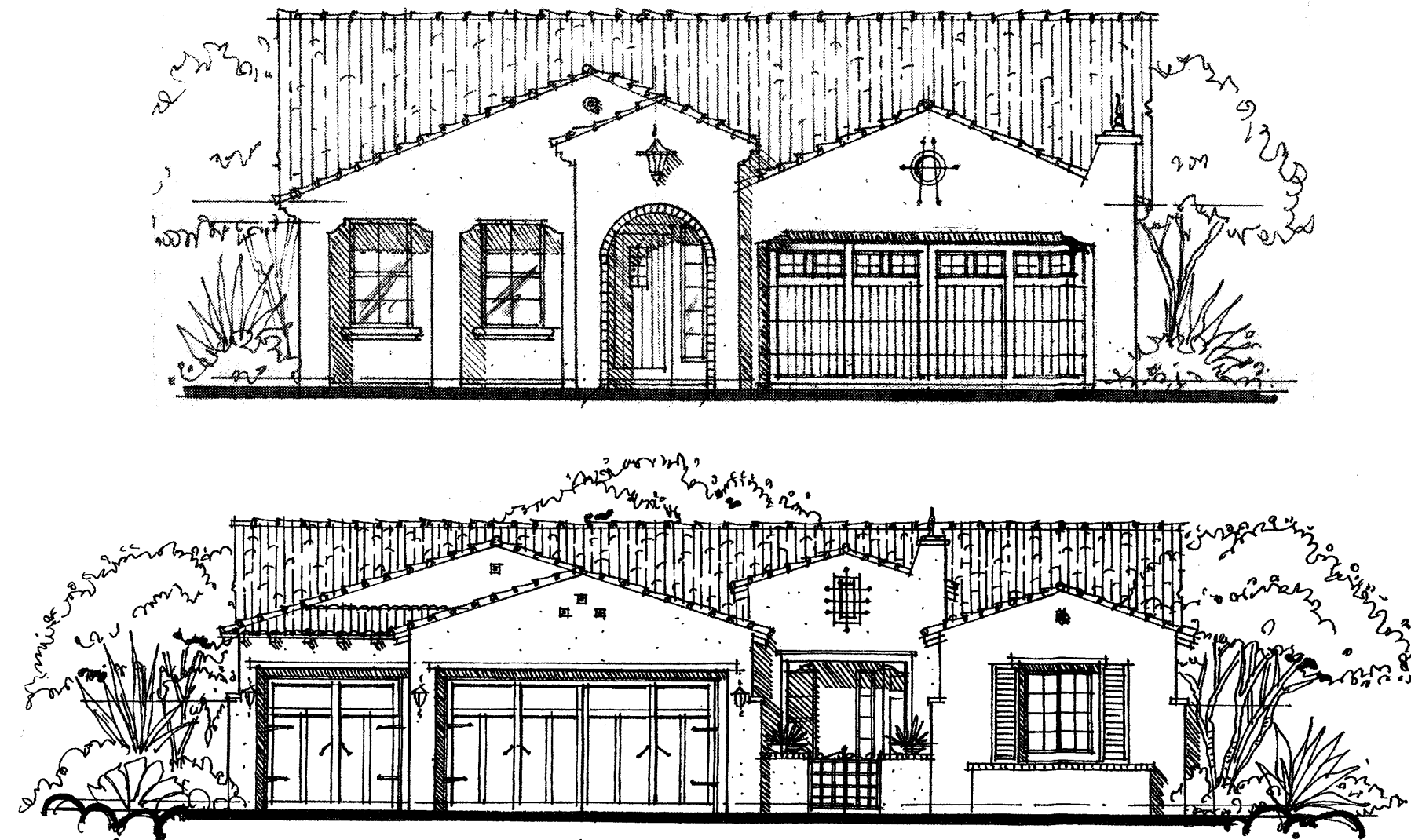

T. ILLUSTRATIVE - REAR-LOADED, FLAT ROOF, ONE AND TWO-STORY UNITS

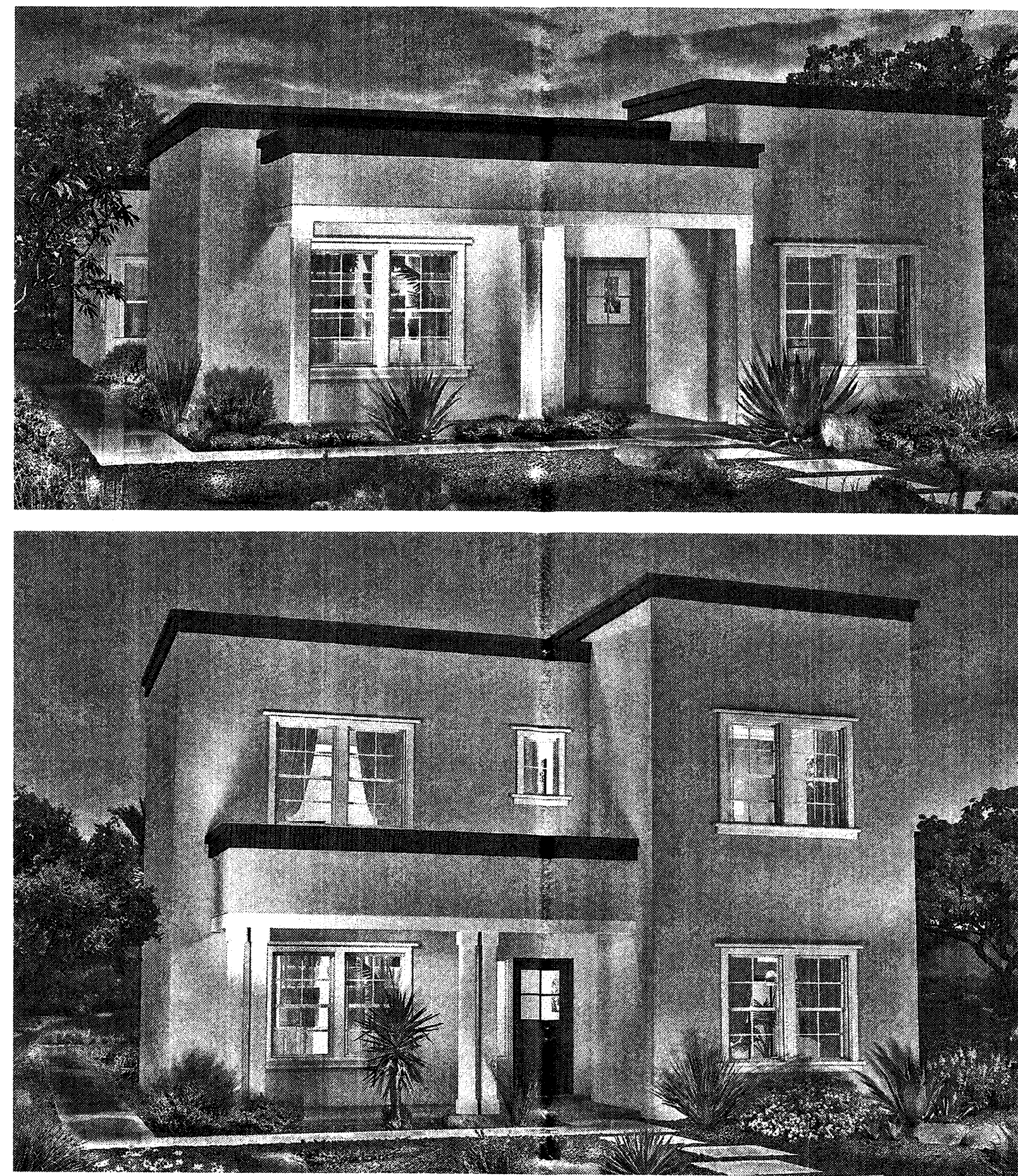

U. ILLUSTRATIVE - FRONT-LOADED, FLAT ROOF, ONE AND TWO-STORY UNITS

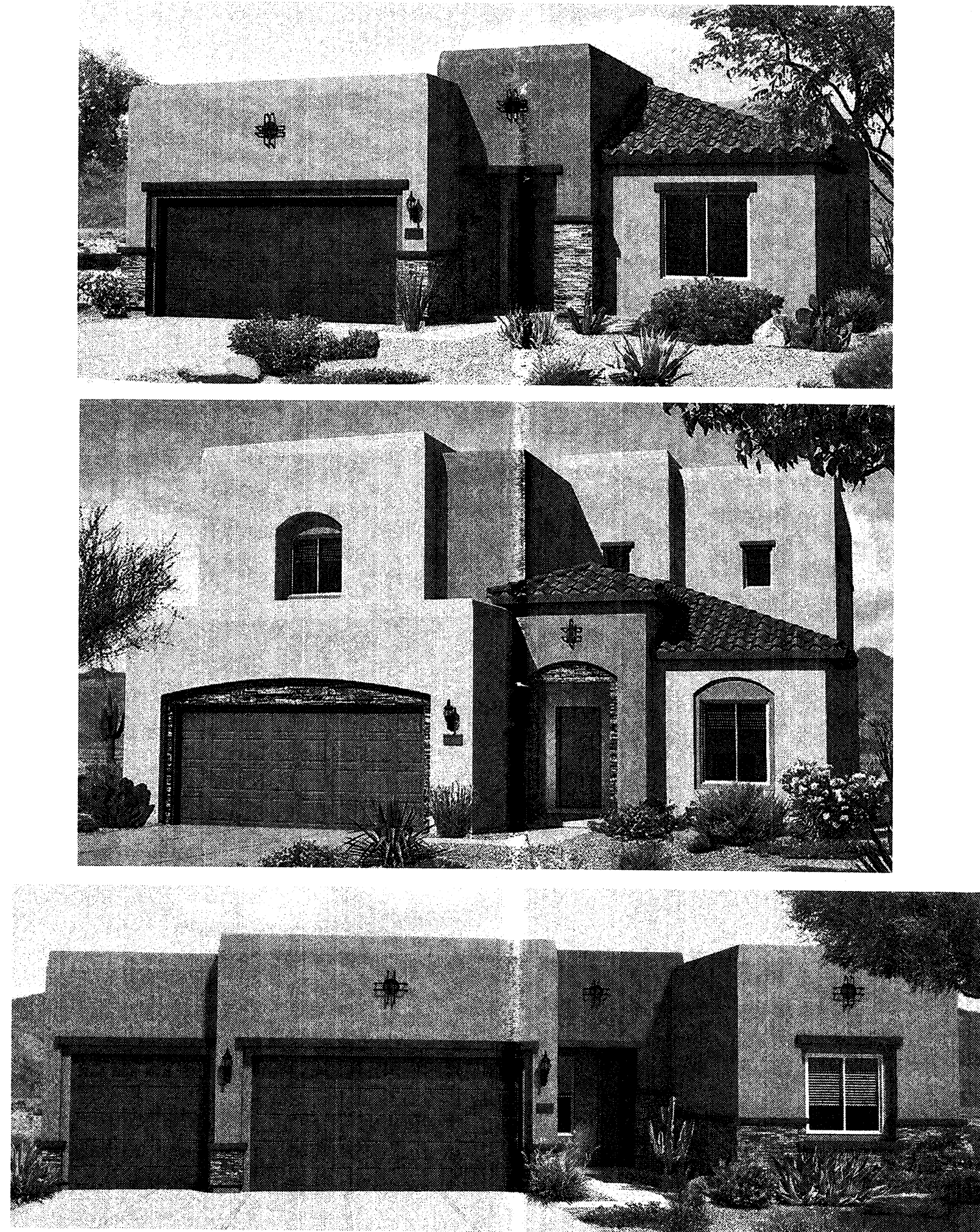

V. ILLUSTRATIVE - FRONT-LOADED, PITCHED and FLAT ROOF, ONE and TWO-STORY UNITS - OPTIONAL J-LOAD GARAGE OR CASITA



WATERSHED @ ESTRELLA

SITE PLAN FOR SUBDIVISION

Prepared For:

Pulte Group

August 30, 2013

Prepared By:

SEC Planning, LLC
 Consensus Planning, Inc.
 Bohannon Huston, Inc.
 Sheet 5 of 8

13. LIGHTING

In order to enhance the safety, security, and visual aesthetics; careful consideration must be given to both the daytime and night-time appearance of the lighting design and fixtures. The primary design objective of the site lighting system shall be to preserve the "dark sky" and maximize public safety, while not affecting adjacent properties, buildings, or roadways with unnecessary glare or reflection.

In order to accomplish the lighting goals, the following standards shall be required for the design of the Watershed lighting program:

- Placement of fixtures and standards shall conform to state and local safety and illumination standards.
- All lights shall be shielded source to prevent spillage onto adjoining properties or light pollution of the existing "dark sky". Cobra lights and high pressure sodium lights are prohibited.
- The maximum height of private clubhouse parking lot fixtures shall be 20 feet.
- The maximum height of street lights shall be 20 feet. Street lights shall be coordinated with and approved by the City of Albuquerque and maintained by the Homeowners' Association.
- Pedestrian lighting shall not exceed 15 feet in height from the adjacent grade to the top of the fixture. Bollards, if provided, shall not be greater than 3 feet in height and shall include shatter-proof covering. Ground-mounted (flush) lights are also allowed.
- ILLUSTRATIVE STREET LIGHT / PEDESTRIAN LIGHT

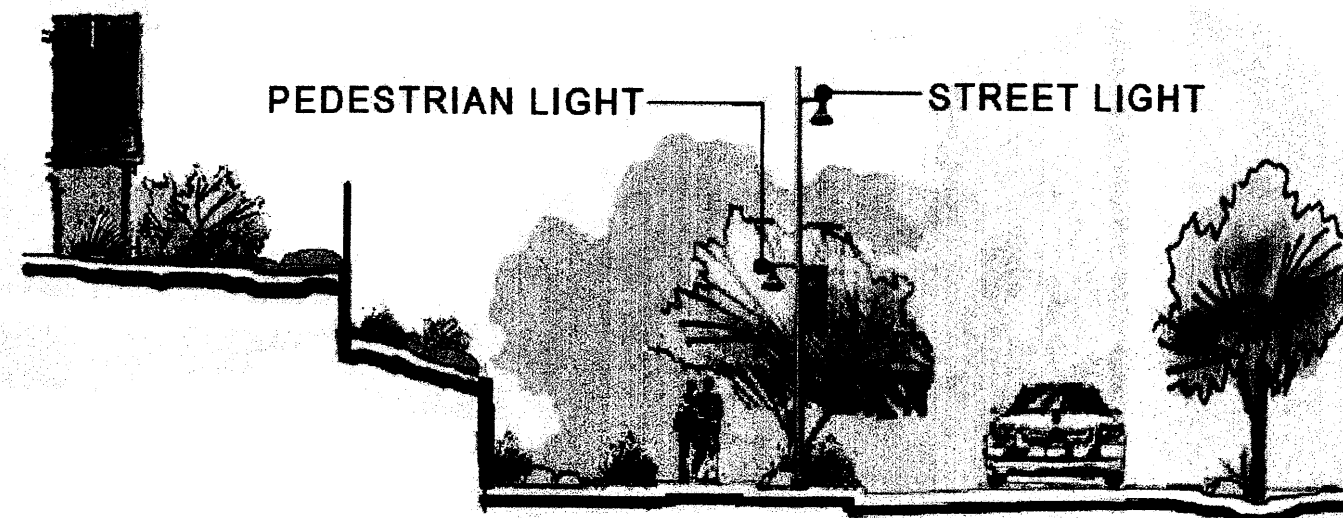

14. LANDSCAPE

The landscape standards shall be required in addition to the City requirements in the Water Conservation Landscaping and Water Waste Ordinance, the Street Tree Ordinance, landscape regulations included in the City of Albuquerque Comprehensive City Zoning Code, and the Westland Master Plan Design Guidelines.

- In locations where residential lots do not face the street, street trees shall be provided along public rights-of-way with either even spacing or in random clusters. The spacing of evenly spaced street trees shall be no greater than the diameter of the street tree canopy at full maturity (i.e. smaller trees require closer spacing than larger trees). Where street trees are randomly clustered, the number of street trees shall be equal to or exceed the number required if trees were evenly spaced; however, gaps between randomly spaced street trees that exceed 50 feet are prohibited.
- Within residential subdivisions, street trees shall be provided at a rate of one tree per residential lot. Street trees shall be planted within 12 feet of the curb.
- Individual residential lot owners will be responsible for the installation and maintenance of the landscape on their property. All plant material, including trees, shrubs, groundcovers, turf, wildflowers, etc. shall be maintained by the lot owner in a living, attractive condition.
- All landscape within Watershed private pocket parks, common areas, rights-of-way, and social lawn / private clubhouse shall be built and maintained by the Homeowners' Association.
- All planting areas not covered with turf shall have a ground topping of river rock, shredded bark, gravel mulch, or similar material which extends completely under the plant material.
- An automatic underground irrigation system shall be provided to support all required landscaping. Irrigation components should be maintained periodically to ensure maximum efficiency.
- All plant materials for residential yards, streetscapes, and social lawn / private clubhouse shall be chosen from the Westland Master Plan Design Guidelines or the Albuquerque Bernalillo County Water Utility Authority Xeriscaping Plant List.
- Plant materials for the natural and private open space areas (excluding the private pocket parks and Social Lawn) shall be chosen from the following list:

NATURALIZED AND PRIVATE OPEN SPACE PLANT PALETTE

TREES

Scientific Name	Common Name
Cercocarpus ledifolius	Curlleaf Mountain Mahogany
Chilopsis linearis	Desert Willow
Juniperus monosperma	Oneseed Juniper
Juniperus scopulorum	Rocket Mountain Juniper, female
Juniperus virginiana	Juniper, female
Leucanea retusa	Golden ball leadtree
Melia azedarach	Chinaberry
Prosopis glandulosa	Honey mesquite
Prosopis pubescens	Screwbean Mesquite
Prosopis torreyana	Western Honey Mesquite
Quercus grisea	Gray Oak
Quercus suber	Cork Oak
Quercus turbinella	Shrub live oak
Sambucus mexicana	Mexican Elder
Sapindus drummondii	Western soapberry
Zizyphus jujuba	Jujube

SHRUBS

Scientific Name	Common Name
Agave sp.	Agave
Artemisia filifolia	Sand sage
Atriplex canescens	Fourwing saltbrush
Brickellia californica	California brickellbush
Salvia domii	Purple sage
Dasylium sp.	Sotol
Fallugia paradoxa	Apache plume
Fouquieria splendens	Ocotillo
Krascheninnikovia lanata	Winterfat
Nolina microcarpa	Beargrass
Opuntia sp.	Prickly pear
Rhus trilobata	Skunkbush sumac
Ribes sp.	Gooseberry
Yucca sp.	Yucca

FORBS, GRASSES, AND GROUNDCOVERS

Scientific Name	Common Name
Abronia villosa	Sand verbena
Andropogon Saccharoides	Silver beardgrass
Abronia villosa	Sand verbena
Andropogon saccharoides	Silver beardgrass
Aristida purpurea	Purple threeawn
Artemisia ludoviciana	Prairie sage
Asclepias speciosa	Showy milkweeds
Baileya multiradiata	Desert Marigold
Bouteloua curtipendula	Sideoats grama
Bouteloua gracilis	Blue grama
Bouteloua eripoda	Black grama
Elymus elymoides	Bottlebrush squirreltail
Eriogonum annuum	Annual buckwheat
Gaillardia pulchella	Firewheel
Hilaria jamesii	Galleta
Linum perenne lewisii	Blue flax
Mirabilis sp.	Four O'clock
Muhlenbergia porteri	Bush Muhly
Oenothera sp.	Evening primrose
Oryzopsis hymenoides	Indian ricegrass
Parthenium incanum	Mariola
Penstemon ambiguus	Bear tongue
Phacelia integrifolia	Scorpionflower
Philostrophe taetina	Paperflower
Sporobolus cryptandrus	Sand dropseed
Zinnia grandiflora	Desert zinnia

- Minimum plant sizes at time of installation shall be as follows:
 - Trees: 2 inch caliper measured 6 inches above grade, or 10 to 12 feet in height
 - Shrubs and low-growing evergreens: 1 gallon
 - Groundcover and turf grass: shall provide general ground coverage within 1 growing season after installation.
- For residential lots, proposed landscape plans shall have a limited amount of turf area, in accordance with the City Comprehensive Zoning Code and Water Conservation Landscaping and Waste Water Ordinance.
- For common areas, turf shall generally be located in high pedestrian use areas, including the private pocket parks and the social lawn. It shall not be planted on slopes greater than 5:1 or in any street medians. If turf is to be used in non-pedestrian areas, it shall be one or a combination of the drought tolerant grass species.
- Landscape and signage shall not interfere with clear sight requirements. All signs, walls, trees, and shrubs between 3 and 8 feet tall (as measured from the gutter pan) shall not be acceptable in this area.
- The landscape within the private clubhouse parking area shall be designed in accordance with the City Zoning Code, Section 14-16-3-10 Landscape Regulations Applicable to Apartment and Nonresidential Development.

15. DRAINAGE

The Mirehaven Arroyo and other drainage ways are intended to be treated as a significant design feature for Watershed, and are considered to be a significant private open space element for the community. The intent is to preserve and stabilize the Mirehaven Arroyo by contouring and stabilizing the arroyo bottom using and maintaining its existing earthen bedding while installing adjacent bank protection and isolated strategically located drop structures.

- The Mirehaven Arroyo shall reflect a more naturalized appearance. The arroyo treatment shall include rip-rap, concrete structures (some hidden) for isolated areas along the bank stabilization and drop structures, and native vegetation instead of concrete for lining drainage ways.
- In order to provide the necessary protection to the adjacent development, vertical and sloped bank stabilization shall be provided. Necessary drop structures shall be provided at isolated areas within the arroyo to control and stabilize the degradation.
- The bottom of the Mirehaven Arroyo shall not be hard-lined concrete, except for isolated drop structures to control and stabilize the natural arroyo bottom.
- The project shall accept existing drainage (generally in a sheet manner, not concentrated) from the Petroglyph National Monument within the 50 foot buffer zone along the north and west edges and intersect the single-loaded roadway that parallels the Monument boundary. The storm water shall be directed safely to the internal downstream drainage infrastructure.
- Where concentrated flows occur from the Monument, the storm water shall be either captured in rain gardens (e.g., water harvesting areas) adjacent to the single-loaded roadway where it will be allowed to pond and overflow into the roadway or captured and directed into a small drainage canal that will convey the stormwater to the internal downstream infrastructure. City Hydrology shall evaluate whether and how ponds should overflow into the roadway on a case-by-case basis.
- No developed flows shall be allowed into Petroglyph National Monument.
- On-site drainage, including rear-lot ponding, is encouraged for decreasing street flows and the need for large, drainage facilities. Detention ponds and other water harvesting methods shall be utilized to supplement landscape irrigation. Pursuant to the City DPM, there will be no credit for rear lot ponding.
- The use of private open space areas and private parks for water harvesting of more frequent storm events (2 and 10 year) is encouraged, with the City's concurrence.
- The use of rear yard alleys may be used for the conveyance of drainage.
- Cut and fill required by drainage and detention facilities shall be rounded whenever possible to avoid steep unnatural slopes.

16. GRADING and SURFACE DISTURBANCE

The intent of the project is to provide for grading that meets the overall intent of the NWMEP and the Westland Master Plan. Within the NWMEP Impact Area, the intent is to generally lower the existing topography so that the building heights can be minimized in order to create a more unobstructed view of the Petroglyph National Monument as viewed from the east and to create better view corridors from the project towards the Rio Grande Bosque and the Sandia Mountains. As related to grading activities, an overall goal for the project is to engage in adequate dust control measures during surface disturbance.

GRADING

- Grading shall comply with the development criteria as defined in the NWMEP Impact Area and the Westland Master Plan.
- Grading plans for the NWMEP Impact Area shall demonstrate that cut and fill has been kept to a minimum, unless the excavation reduces the profile of construction in a way that materially improves the site plan. Cut and fill shall be done in a manner that does not negatively impact trail feasibility.
- The transition between new grades and the existing terrain shall be smooth and rounded. All graded slopes and disturbed areas shall be revegetated to prevent soil erosion.
- Individual parcels shall be graded in such a way to direct runoff away from buildings and into drainage facilities.
- Grading for new roads should run with the existing contours, whenever feasible. Natural drainage patterns should be maintained to prevent soil erosion.
- Graded slopes, in conjunction with landscape materials and walls, may be used to help screen the parking area at the private clubhouse.
- Retaining walls may be used as a technique to minimize grading and stabilize slopes. Terracing of walls is encouraged for retaining walls, and shall be designed in accordance with the City Comprehensive Zoning Code, Section 14-16-3-19, General Height and Design Regulations for Walls, Fences, and Retaining Walls.
- Slope enhancements shall include local boulder stabilization and revegetation with a native flora mix including grasses, forbs, shrubs, and limited native trees chosen from the plant palette provided in Section 14, Landscape, to lend the landscape an appearance and function similar to that of the undisturbed expanses of the adjacent Petroglyph National Monument.
- Areas which are damaged or altered shall be restored through the replacement of boulders to approximate the original location, angle, and surface exposure. Revegetation to approximate original cover with appropriate native or naturalized plants as identified in Section 14, Landscape, is required within 90 days of project completion. A variance may be granted if the type of vegetation or time of year make vegetation within 90 days impossible.

J. ILLUSTRATIVE GRADING PHASING PLAN

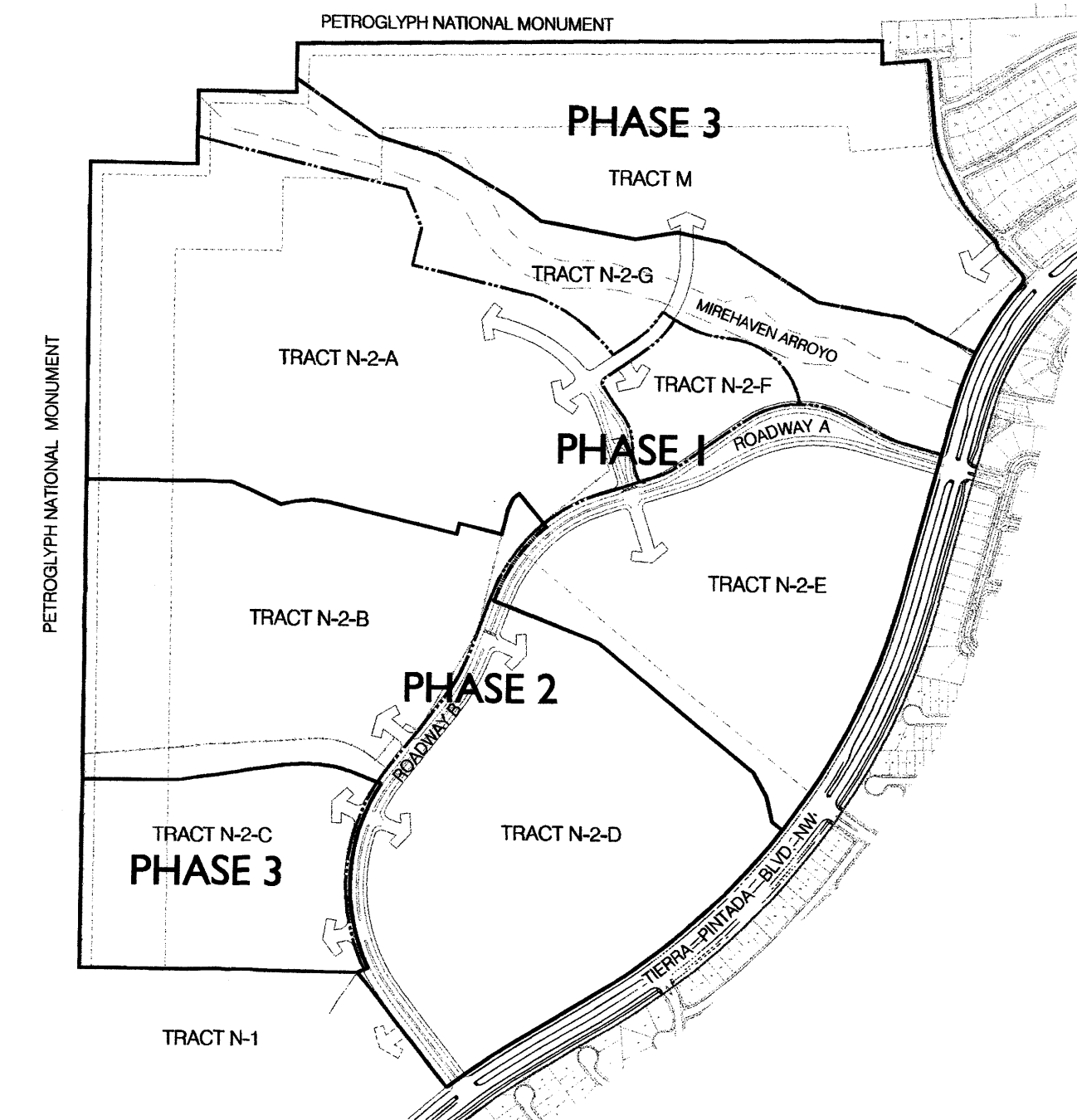

- The Grading Phasing Plan is illustrative. Specific grading and drainage plans shall be reviewed and approved by City Hydrology.

SURFACE DISTURBANCE

- The developer shall obtain a fugitive dust control permit as required pursuant to Albuquerque/Bernalillo County Air Quality Control Board (AQCB) regulations and shall comply with these regulations.
- Reasonably available control measures (RACT), or any other effective control measure, shall be used during active operations and/or on inactive disturbed surface areas as necessary to prevent the release of fugitive dust.
- The developer shall comply with any applicable EPA regulations concerning surface disturbance that are applicable at the time of development of the individual tracts.

WATERSHED @ ESTRELLA

SITE PLAN FOR SUBDIVISION

Prepared For:

Pulte Group

September 11, 2013

Prepared By:

SEC Planning, LLC
Consensus Planning, Inc.
Bohannon Huston, Inc.
Sheet 6 of 8

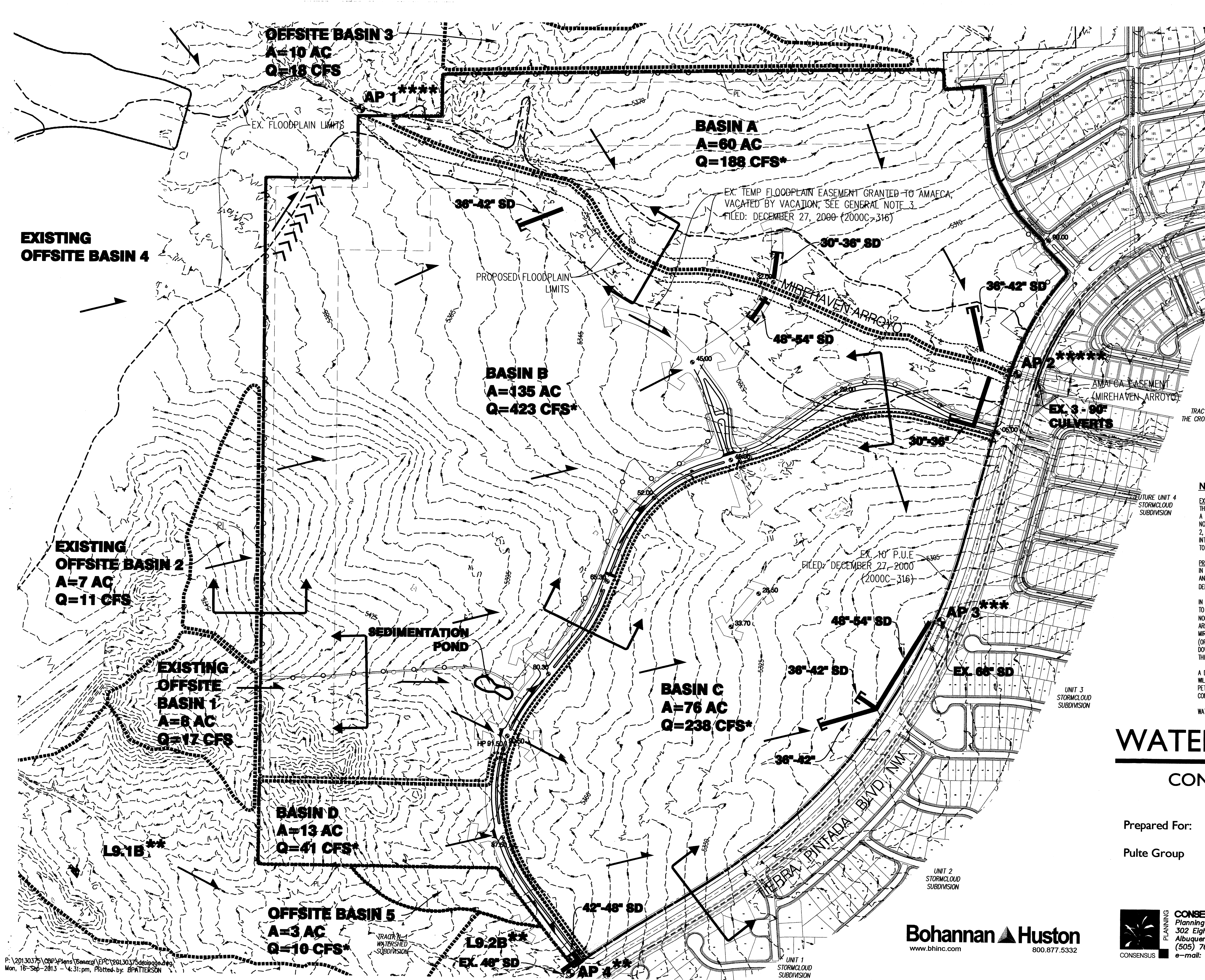

LEGEND

- PROPOSED STORM DRAIN
- STORM DRAIN CULVERT
- EXISTING STORM DRAIN
- FLOW ARROWS
- PROPOSED SPOT ELEVATION
- DIVERSION BANK
- EXISTING FLOODPLAIN LIMITS
- PROPOSED FLOODPLAIN LIMITS
- PROPOSED BASIN BOUNDARY
- PROPOSED FENCE

ANALYSIS POINT	Qallowable (CFS)	Qproposed (CFS)
1	N/A	1373****
2	1495*****	1495
3	375***	238
4	216**	216

* BASED ON 3.17 DU/AC AND USING THE DPM TABLE A-5, GIVES A Q VALUE OF 3.13 CFS/AC
 ** PER "DRAINAGE ANALYSIS REPORT FOR ARROYO VISTA BLVD & TIERRA PINTADA BLVD", APRIL 4, 2012
 *** PER "DRAINAGE REPORT FOR STORMCLOUD SUBDIVISION", MAY 27, 2005
 ****UPSTREAM FLOWS ARE FROM "WEST I-40 DMP UPDATE 2011", DECEMBER 2011
 ***** PER TECHNICAL MEMORANDUM "PRELIMINARY HYDRAULIC ANALYSIS FOR MIREHAVEN ARROYO CROSSING", JANUARY 10, 2012.

- GENERAL NOTES**
- EXISTING TOPO CONTOURS ARE SHOWN AT 5' INTERVALS.
 - FOR ALL CROSS SECTIONS, PLEASE SEE THE SITE PLAN FOR SUBDIVISION SHEETS.
 - THE EXISTING AMAFCA TEMPORARY FLOODPLAIN EASEMENT WILL BE VACATED BY FUTURE ACTION BY EITHER REMOVING ALL OR A PORTION OF THE EASEMENT / FLOODPLAIN TO CONTAIN THE SAID EASEMENT / FLOODPLAIN WITHIN THE PROPOSED CHANNEL LIMITS. IT IS ANTICIPATED THAT AMAFCA MAY ASSIGN THEIR TEMPORARY FLOODPLAIN EASEMENT TO THE CITY OF ALBUQUERQUE BY FUTURE ACTION. A LETTER OF MAP REVISION WILL BE REQUIRED TO REMOVE ALL OR A PORTION OF THE EXISTING FLOODPLAIN.
 - DESIGN CRITERIA FOR GRADING AND DRAINAGE WILL FOLLOW DESIGN STANDARDS ESTABLISHED IN THE NORTHWEST MESA ESCARPMENT PLAN AND THE WESTLAND MASTER PLAN AS DESCRIBED IN THE DESIGN STANDARDS.
 - SIZES OF PROPOSED STORM DRAIN STUBS ASSUME A SLOPE RANGE OF 2-5%.

NARRATIVE

EXISTING CONDITIONS
 THE EXISTING TOPOGRAPHY SLOPES FROM WEST TO EAST ACROSS THE SITE AND RANGE FROM 4% - 15%. A SIGNIFICANT PORTION OF THE SITE DRAINS TO THE MIREHAVEN ARROYO, WHICH RUNS THROUGH THE NORTHERN PORTION OF THE SITE. STORM WATER FLOWS THAT LEAVE THE SITE, DO SO AT ANALYSIS POINTS 2, 3 AND 4. THERE IS AN EXISTING SWALE ALONG THE WEST SIDE OF TIERRA PINTADA BLVD WHICH INTERCEPTS UPLAND STORM WATER AND CONVEYS IT TO EXISTING STORM DRAINS THAT DIRECT THE WATER TO THE AMAFCA LADERA FACILITIES.

PROPOSED CONDITIONS
 IN THE PROPOSED CONDITION, GRADING WILL BE DESIGNED WITH THE USE OF TERRACED RETAINING WALLS AND SLOPING WITHIN OPEN SPACE AREA. SEE SITE PLAN FOR SUBDIVISION SHEETS FOR CROSS SECTIONS DEPICTING HOW THIS MIGHT BE ACCOMPLISHED ALONG THE PERIMETER / BOUNDARY.

IN THE PROPOSED CONDITION, DRAINAGE PATTERNS WILL REMAIN FOR THE MOST PART THE SAME, DRAINING TO THE EAST INTO THE EXISTING DRAINAGE INFRASTRUCTURE AND TO THE MIREHAVEN ARROYO TO THE NORTH. WE WILL SUBMIT A LOMR/CLOMR TO REDUCE THE EXISTING FLOODPLAINS OF THE MIREHAVEN ARROYO WITHIN THE STRETCH OF THE WATERSHED SITE LIMITS. WE ANTICIPATE DUPLICATING DOWNSTREAM MIREHAVEN ARROYO IMPROVEMENTS BY STABILIZING THE MIREHAVEN ARROYO BANKS WHILE LEAVING A SOFT (OR NATURAL) BOTTOM WITH ISOLATED DROP STRUCTURES AS NECESSARY. BY REPLICATING THE DOWNSTREAM IMPROVEMENTS, WE ESTIMATE A WATER SURFACE ELEVATION OF APPROXIMATELY 3.5 FT IN THIS SECTION OF THE MIREHAVEN ARROYO.

A DIVERSION BANK IS PROPOSED ALONG THE NORTHWEST BOUNDARY OF THE SITE. THE DIVERSION BANK WILL BE CONSTRUCTED ONSITE AND IS INTENDED TO DIVERT EXISTING, UNDEVELOPED FLOWS FROM THE PETROGLYPH NATIONAL MONUMENT NORTH INTO THE MIREHAVEN ARROYO. THE DIVERSION BANK SHALL BE CONSTRUCTED TO AVOID CONFLICTS WITH PROPOSED IMPROVEMENTS INCLUDING THE PERIMETER TRAIL.

WATER HARVESTING TECHNIQUES WILL BE IMPLEMENTED WHERE POSSIBLE.

WATERSHED @ ESTRELLA

CONCEPTUAL GRADING AND DRAINAGE PLAN

Prepared For: Pulte Group

Prepared By: SEC Planning, LLC
 Consensus Planning, Inc.
 Bohannon Huston, Inc.

Bohannon Huston
 www.bhinc.com 800.877.5332

CONSENSUS PLANNING, INC.
 Planning / Landscape Architecture
 302 Eighth Street NW
 Albuquerque, NM 87102
 (505) 764-9801 Fax 842-5495
 e-mail: cp@consensusplanning.com

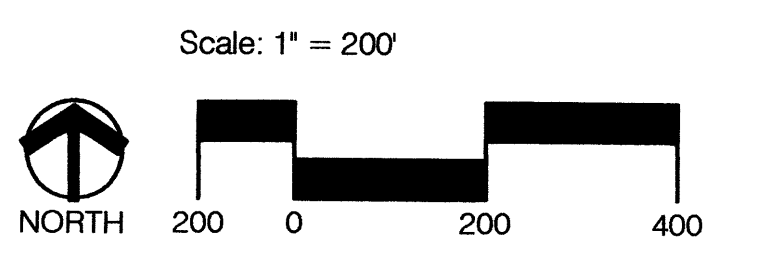

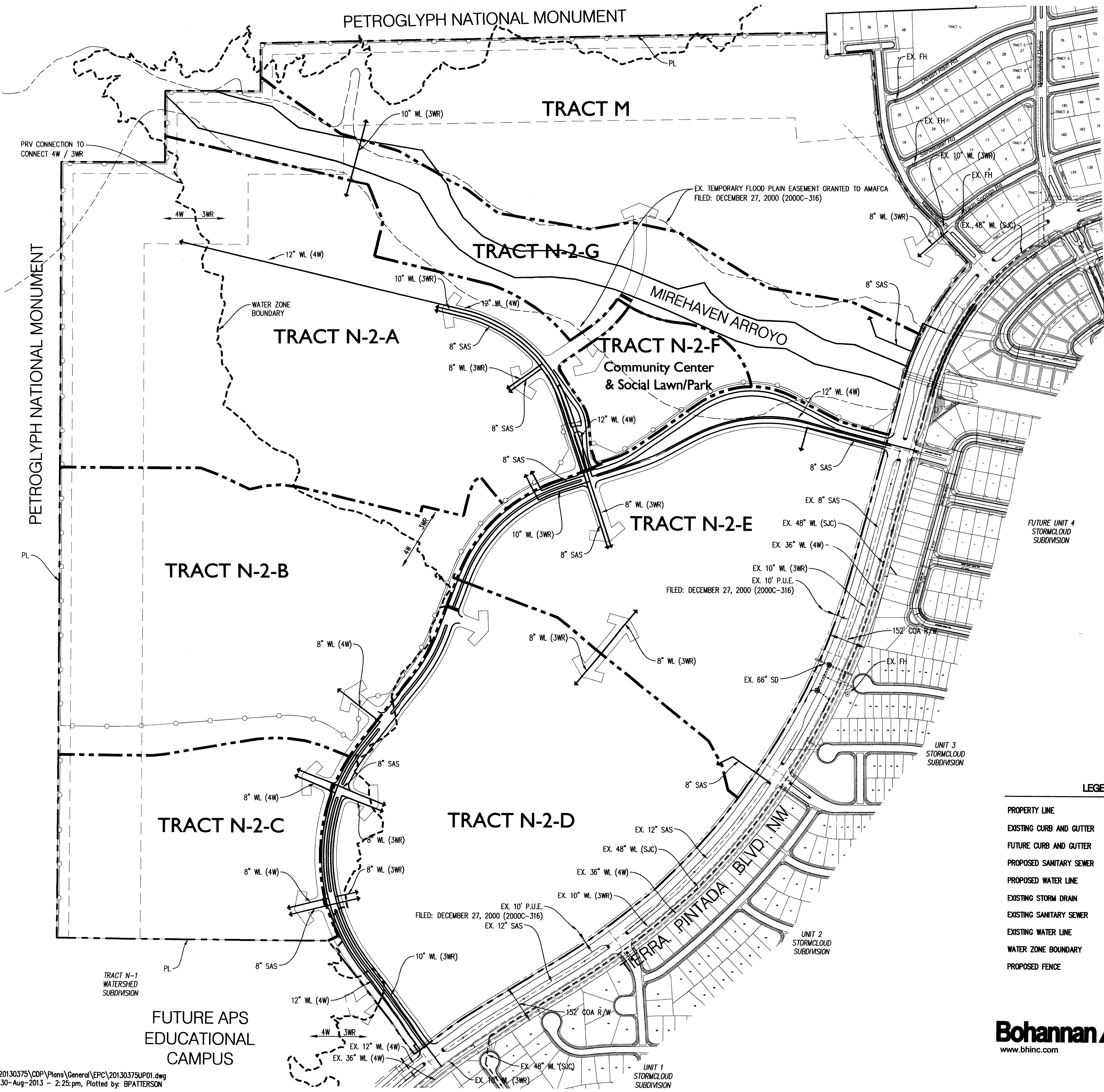

GENERAL NOTES

1. ALL WATER AND SANITARY SEWER LINES SHALL BE LOCATED WITHIN CITY OF ALBUQUERQUE (COA) PUBLIC RIGHT-OF-WAY OR WITHIN A UTILITY EASEMENT THAT WILL BE DEDICATED TO ALBUQUERQUE BERNALILLO COUNTY WATER UTILITY AUTHORITY (ABCWUA) WITH FUTURE PLATS.
2. ALL EXISTING WATER AND SANITARY SEWER LINES ARE LOCATED WITHIN CITY OF ALBUQUERQUE (COA) PUBLIC RIGHT-OF-WAY OR WITHIN AN EXISTING UTILITY EASEMENT.
3. UTILITY LINES AND FIRE HYDRANT'S SHALL BE LOCATED PER CRITERIA STATED IN THE COA'S DEVELOPMENT PROCESS MANUAL.
4. ALL FUTURE WATER AND SANITARY SEWER LINES SHALL BE DESIGNED IN ACCORDANCE WITH CRITERIA STATED IN THE APPROVED WATER-SANITARY SEWER AVAILABILITY LETTER PROVIDED BY ABCWUA.
5. FUTURE SANITARY SEWER LINES WILL TIE TO EXISTING 8" AND 12" SANITARY SEWER LINES IN TIERRA PINTADA BLVD.
6. THE SITE LIES WITHIN TWO (2) WATER PRESSURE ZONES: 4W AND 3WR.

WATER PRESSURE ZONE 4W
 -THERE IS AN EXISTING 10"/12" WATERLINE LOCATED IN TIERRA PINTADA BLVD THAT APPEARS WILL BE ABLE TO SERVE FUTURE LOTS LOCATED WITHIN THE 4W WATER PRESSURE ZONE.
 -THERE IS AN EXISTING 36" TRANSMISSION LINE WITHIN TIERRA PINTADA BLVD AND ADJACENT TO THE PROPOSED DEVELOPMENT.
 -THERE IS A 48" SAN JUAN-CHAMA WATERLINE ADJACENT TO THE PROPERTY LOCATED WITH TIERRA PINTADA BLVD.

WATER PRESSURE ZONE 3WR
 -THERE IS AN EXISTING 36" TRANSMISSION LINE LOCATED IN TIERRA PINTADA BLVD.
 -THERE IS AN EXISTING 10" WATERLINE LOCATED IN TIERRA PINTADA BLVD.
 -THERE IS AN EXISTING 10" WATERLINE LOCATED IN WESTCREEK PLACE.

LEGEND

PROPERTY LINE	---
EXISTING CURB AND GUTTER	==
FUTURE CURB AND GUTTER	====
PROPOSED SANITARY SEWER	---
PROPOSED WATER LINE	---
EXISTING STORM DRAIN	---
EXISTING SANITARY SEWER	---
EXISTING WATER LINE	---
WATER ZONE BOUNDARY	-----
PROPOSED FENCE	○

WATERSHED @ ESTRELLA

CONCEPTUAL UTILITY PLAN

Prepared For:
 Pulte Group

Prepared By:
 SEC Planning, LLC
 Consensus Planning, Inc.
 Bohannon Huston, Inc.

Bohannon & Huston
 www.bhinc.com 800.877.5332

CONSENSUS PLANNING, INC.
 Planning / Landscape Architecture
 302 Eighth Street NW
 Albuquerque, NM 87102
 (505) 764-9801 Fax 842-5495
 e-mail: cp@consensusplanning.com

