



DEVELOPMENT HEARING OFFICER
SUPPLEMENTAL SUBMITTAL

(Deadline is Friday at noon unless noted on DHO calendar – late submittals will not be accepted unless approved by the DHO)

PROJECT NO. PR-2020-003484

Application No. SD-2023-00048

TO:

- Planning Department
- Hydrology
- Transportation Development
- ABCWUA
- Code Enforcement
- Parks & Rec
- City Engineer

*(Please attach this sheet with each collated set for each DFT member)

NOTE: ELECTRONIC VERSION is Required. Submittal will not be accepted without.

DHO SCHEDULED HEARING DATE: November 8, 2023 HEARING DATE OF DEFERRAL: October 25, 2023

SUBMITTAL DESCRIPTION: Preliminary Plat and excavation exhibit for sanitary sewer connection.

CONTACT NAME: THE Group / Ron E. Hensley

TELEPHONE: 505-470-1622 EMAIL: ron@thegroup.cc

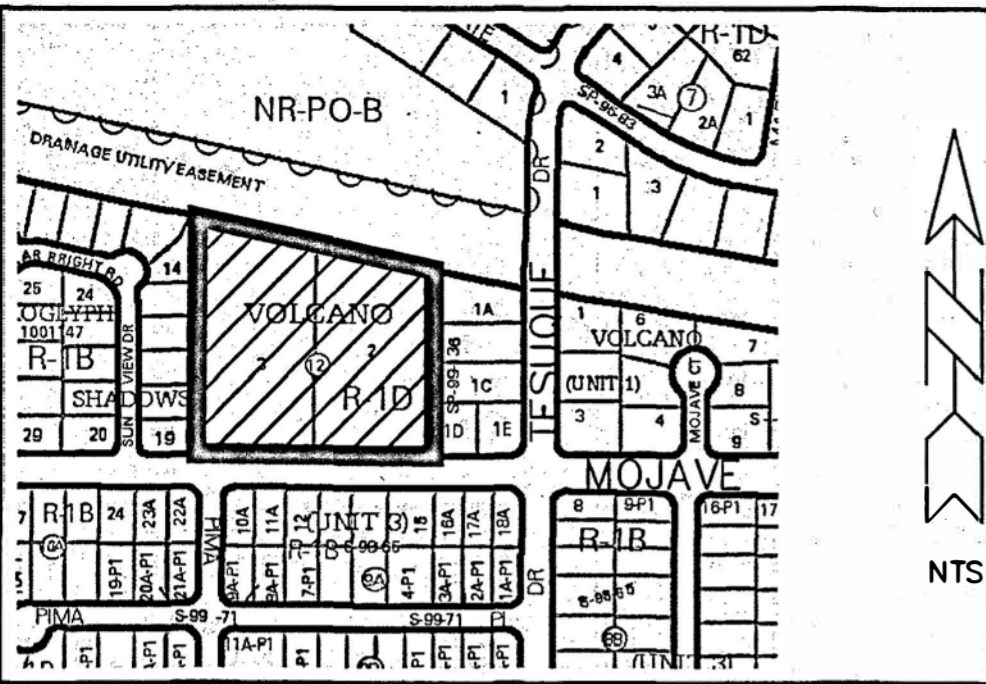

LOCATION MAP E-10-Z

PURPOSE OF PLAT

1. To eliminate lot line and create lots as shown hereon.
2. To grant and vacate easements as shown hereon.
3. To dedicate public street right-of-way as shown hereon.

SUBDIVISION DATA

1. Project No.:
2. Application No.:
3. Zone Atlas Index No.: E-10-Z
4. Total Number of Lots created: 18
5. Total Number of Tracts created: 1
6. Total Number of existing Lots: 2
7. Gross Subdivision Acreage: 4.2482 Acres
8. Public street right-of-way dedicated: 0.7587 Acres

NOTES

1. Bearings are New Mexico State Plane Grid Bearings (Central Zone).
2. Distances are ground distances.
3. Bearings and distances in parenthesis are record.
4. Basis of boundary is the plat of record entitled: "VOLCANO CLIFFS SUBDIVISION, UNIT 3", (02-15-1966, C06-107) all being records of Bernalillo County, New Mexico.
5. Field Survey: August, 2021.
6. Title Report(s): None provided.
7. Address of Property: Mojave Street NW, Albuquerque, NM 87120
8. City of Albuquerque, New Mexico IDO Zone: R-1D
9. 100 Year Flood Zone Designation: ZONE X and ZONE AE (REGULATORY FLOODWAY) as shown on Panel 112 of 825, Flood Insurance Rate Map, City of Albuquerque, Bernalillo County, New Mexico, dated September 26, 2008, City of Albuquerque, Bernalillo County, New Mexico, and revised to reflect LOMR effective February 16, 2017.
10. Unless shown otherwise all points are set 1/2" rebar with cap or PK nail with tag "LS 7719".

FREE CONSENT AND DEDICATION

The subdivision hereon described is with the free consent and in accordance with the desires of the undersigned owner(s) and/or proprietor(s) thereof. Said owner(s) and/or proprietor(s) do hereby consent to the creation of lots as shown hereon. Said owner(s) and/or proprietor(s) do hereby consent to the granting and vacating of easements as shown hereon. Said owner(s) and/or proprietor(s) do hereby dedicate public street right-of-way to the City of Albuquerque in fee simple with warranty covenants. Said owner(s) and/or proprietor(s) do hereby consent to all the foregoing and do hereby certify that this subdivision is their free act and deed. Said owner(s) warrant that they hold among them complete and indefeasible title in fee simple to the land subdivided.

Owner: Nafeesa Pashtoon 12/12/2022
 Nafeesa Pashtoon

BRIANNA VASQUEZ
 Notary Public - State of New Mexico
 Commission # 1126074
 My Comm. Expires May 13, 2023

STATE OF NEW MEXICO)
 BERNALILLO COUNTY)
 On this 12 day of December, 2022, this instrument was acknowledged before me by Nafeesa Pashtoon.
[Signature]
 Notary Public

DESCRIPTION

A tract of land situate within Section 27, Township 11 North, Range 2 East, New Mexico Principal Meridian, City of Albuquerque, Bernalillo County, New Mexico, being all of LOTS 2 & 3, BLOCK 12, UNIT 3, VOLCANO CLIFFS SUBDIVISION, as the same is shown and designated on said plat, filed for record in the office of the County Clerk of Bernalillo County, New Mexico, on February 15, 1966, in Plat Book C06, Page 107, and containing 4.2482 acres more or less.

PUBLIC UTILITY EASEMENTS

PUBLIC UTILITY EASEMENTS shown on this plat are granted for the common and joint use of:

1. Public Service Company of New Mexico (PNM) for the installation, maintenance and service of overhead and underground electrical lines, transformers, and other equipment, fixtures, structures and related facilities reasonably necessary to provide electrical services.
2. New Mexico Gas Company (NMGCO) for installation, maintenance, and service of natural gas lines, valves and other equipment and facilities reasonably necessary to provide natural gas services.
3. Lumen for installation, maintenance and service of all buried and aerial communication lines and other related equipment and facilities reasonably necessary to provide communication services, including but not limited to above ground pedestals and enclosures.
4. Comcast for the installation, maintenance, and service of such lines, cable and other related equipment and facilities reasonably necessary to provide Cable TV services.

Included, is the right to build, rebuild, construct, reconstruct, locate, relocate, change, remove, modify, renew, operate, and maintain facilities for the purposes described above, together with free access to, from, and over said right-of-way and easement, with the right and privilege of going upon, over and across adjoining lands of Grantor for the purposes set forth herein and with the right to utilize the right-of-way and easement to extend services to customers of Grantee, and to trim and remove trees, shrubs or bushes which interfere with the purposes set forth herein. No building, sign, pool (above ground or subsurface), hot tub, concrete or wood pool decking, or other structure shall be erected or constructed on said easements, nor shall any well be drilled or operated thereon. Property owners shall be solely responsible for correcting any violations of National Electrical Safety Code by construction of pools, decking, or any structures adjacent to or near easements shown on this plat. Easements for electric transformers/switchgears, as installed, shall extend ten (10) feet in front of transformer/switchgear doors and five (5) feet on each side.

DISCLAIMER

In approving this plat, PNM, NMGCO, LUMEN and COMCAST did not conduct a title search of the properties shown hereon. Consequently, PNM, NMGCO, LUMEN and COMCAST do not waive or release any easement or easement rights which may have been granted by prior plat, replat or other document and which are not shown on this plat.

SOLAR NOTE

No property within the area of requested final action shall at any time be subject to a deed restriction, covenant or binding agreement prohibiting solar collectors from being installed on buildings or erected on the lots or parcels within the area of this plat.

PRELIMINARY PLAT FOR
 MOJAVE RIDGE SUBDIVISION
 (A REPLAT OF LOTS 2 & 3, BLOCK 12,
 UNIT 3, VOLCANO CLIFFS SUBDIVISION)

WITHIN
 SECTION 27,
 TOWNSHIP 11 NORTH, RANGE 2 EAST, N.M.P.M.
 CITY OF ALBUQUERQUE
 BERNALILLO COUNTY, NEW MEXICO
 JANUARY, 2023

PROJECT NUMBER: _____
 Application Number: _____

PLAT APPROVAL

Utility Approvals:

<u>[Signature]</u>	02/26/2023
Public Service Company of New Mexico	Date
<u>[Signature]</u>	2/8/2023
New Mexico Gas Company	Date
<u>Abdul A. Bhuiyan</u>	02/07/2023
Lumen	Date
<u>Wikea Morten</u>	02/07/2023
Comcast	Date

City Approvals:

<u>Loren N. Rianchover P.S.</u>	1/27/2023
City Surveyor	Date

Real Property Division	Date
Traffic Engineering, Transportation Division	Date
Albuquerque-Bernalillo County Water Utility Authority	Date
Parks and Recreation Department	Date
<u>[Signature]</u>	2/21/2023
AMAFA	Date
City Engineer/Hydrology	Date
Code Enforcement	Date
Solid Waste Management	Date
Development Hearing Officer, Planning Department	Date

SURVEYOR'S CERTIFICATION

"I, Timothy Aldrich, a duly qualified Registered Professional Land Surveyor under the laws of the State of New Mexico, do hereby certify that this plat and description were prepared by me or under my supervision, shows all easements as shown on the plat of record or made known to me by the owners and/or proprietors of the subdivision shown hereon, utility companies and other parties expressing an interest and meets the minimum requirements for monumentation and surveys of the Albuquerque Subdivision Ordinance, and further meets the Minimum Standards for Land Surveying in the State of New Mexico, and is true and correct to the best of my knowledge and belief."



[Signature] 01-27-2023
 Timothy Aldrich, P.S. No. 7719 Date

01-27-23 rev
 12-06-22 rev
 05-31-23 rev 01-06-22 rev

Drawn By: TA	Date: 01-02-22
Checked By: TA	Drawing Name: 21090PLT.DWG
Job No.: 21-090	Sheet: 1 of 3



P.O. BOX 30701, ALBQ., N.M. 87190
 505-884-1990

PRELIMINARY PLAT FOR
MOJAVE RIDGE SUBDIVISION
 (A REPLAT OF LOTS 2 & 3, BLOCK 12,
 UNIT 3, VOLCANO CLIFFS SUBDIVISION)
 WITHIN
 SECTION 27,
 TOWNSHIP 11 NORTH, RANGE 2 EAST, N.M.P.M.
 CITY OF ALBUQUERQUE
 BERNALILLO COUNTY, NEW MEXICO
 JANUARY, 2023

EXISTING EASEMENTS

- ① EXISTING 7' PUBLIC UTILITY EASEMENT (PUE)
(02-15-1966, C06-107)
- ② EXISTING 5' PUBLIC UTILITY EASEMENT (PUE)
(02-15-1966, C06-107)
-  PORTION 5' PUBLIC UTILITY EASEMENT (PUE)
(02-15-1966, C06-107)
(VACATED BY THIS PLAT)

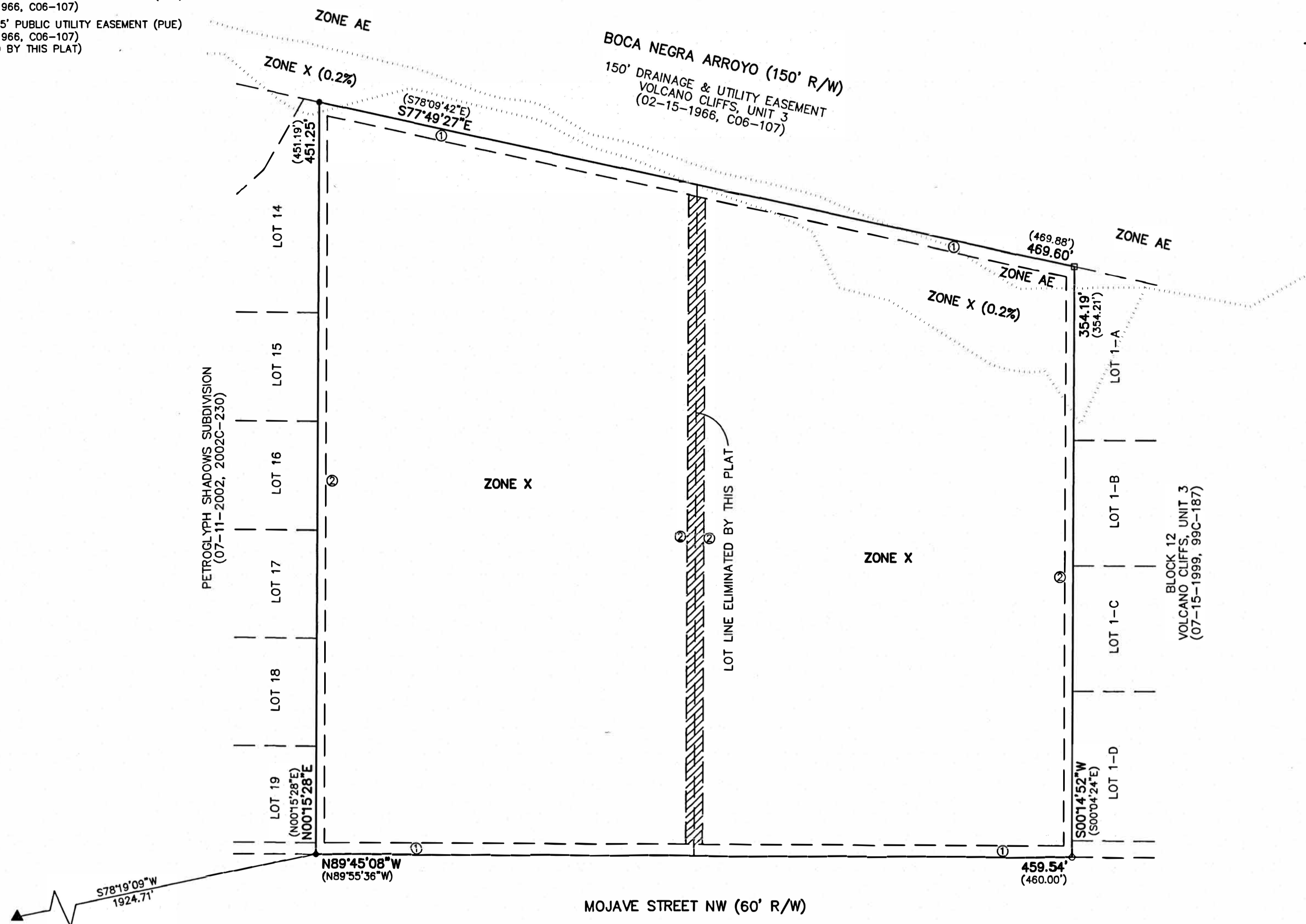

AGRS MONUMENT
 "3-E10"
 N=1512627.946 (US SURVEY FOOT)
 E=1499059.808 (US SURVEY FOOT)
 G-G=0.999672416
 Δα=-00°16'20.35"
 CENTRAL ZONE
 ELEVATION=5318.888 (US SURVEY FOOT)
 (NAD83/NAVD88)

PROPERTY CORNERS

- FOUND PK NAIL WITH TAG "LS 7719"
- FOUND 1" PIPE
- △ FOUND CROSS ON CONCRETE SIDEWALK
- SET 1/2" REBAR WITH CAP "7719"

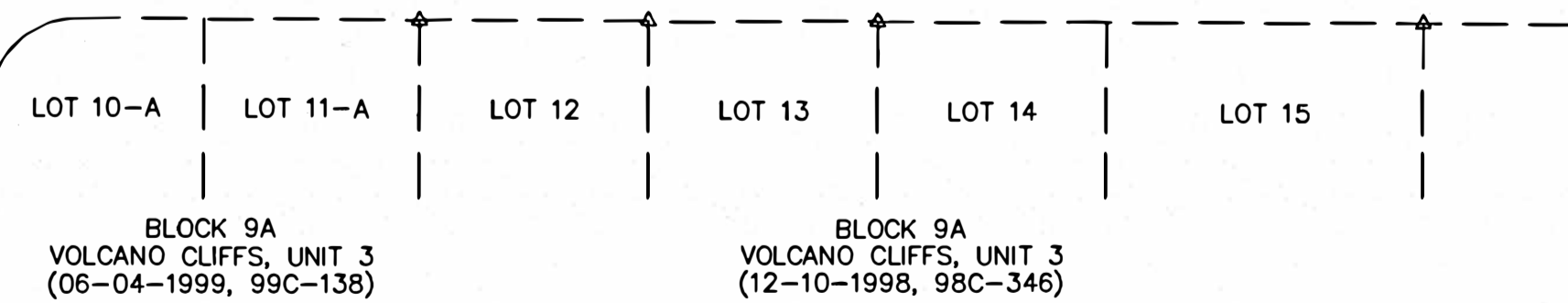
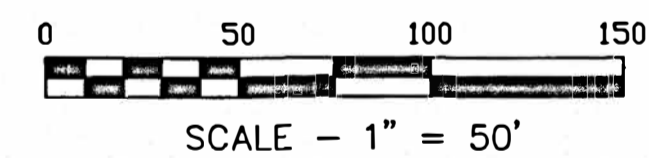

Drawn By:	TA	Date:	01-02-22
Checked By:	TA	Drawing Name:	21090PLT.DWG
Job No.:	21-090	Sheet:	2 of 3

01-27-23 rev
 12-06-22 rev

ALDRICH LAND SURVEYING
 P.O. BOX 30701, ALBQ., N.M. 87190
 505-884-1990

PRELIMINARY PLAT FOR
MOJAVE RIDGE SUBDIVISION
 (A REPLAT OF LOTS 2 & 3, BLOCK 12,
 UNIT 3, VOLCANO CLIFFS SUBDIVISION)
 WITHIN
 SECTION 27,
 TOWNSHIP 11 NORTH, RANGE 2 EAST, N.M.P.M.
 CITY OF ALBUQUERQUE
 BERNALILLO COUNTY, NEW MEXICO
 JANUARY, 2023

NEW EASEMENTS

- ④ 10' PUBLIC UTILITY EASEMENT (PUE)
(GRANTED BY THIS PLAT)
- ⑤ PUBLIC ACCESS AND DRAINAGE EASEMENT
(TO BE MAINTAINED BY THE HOA)
(GRANTED TO THE CITY OF ALBUQUERQUE BY THIS PLAT)
- ⑥ ABCWUA PUBLIC SANITARY SEWER AND WATER EASEMENT
(TO BE MAINTAINED BY THE ABCWUA)
(GRANTED TO ABCWUA BY THIS PLAT)
- ⑦ MAJOR PUBLIC OPEN SPACE LANDSCAPE BUFFER
(VEGETATION TO BE APPROVED BY THE OPEN
SPACE SUPERINTENDENT)
(TO BE MAINTAINED BY THE HOA)
(GRANTED TO THE CITY OF ALBUQUERQUE BY THIS PLAT)

All street centerlines shall be monumented at all PC's, PT's, Angle
 Points and Intersections designated thus "▲". Monuments shall be
 marked as follows:
 "CITY OF ALBUQUERQUE CENTERLINE MONUMENTATION"
 "DO NOT DISTURB"
 "PLS # 7719"

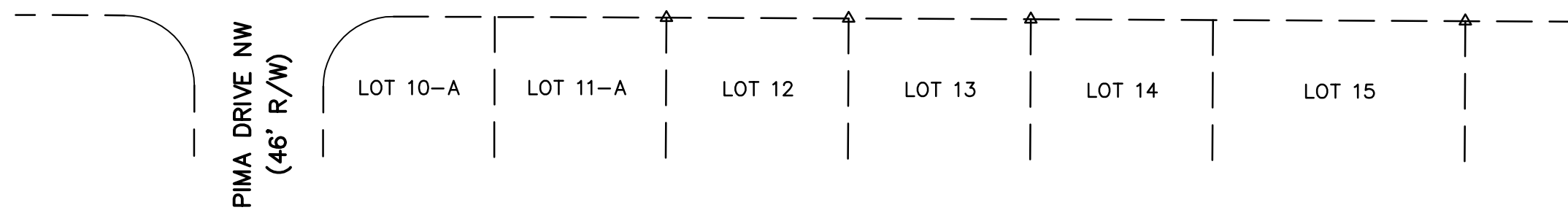
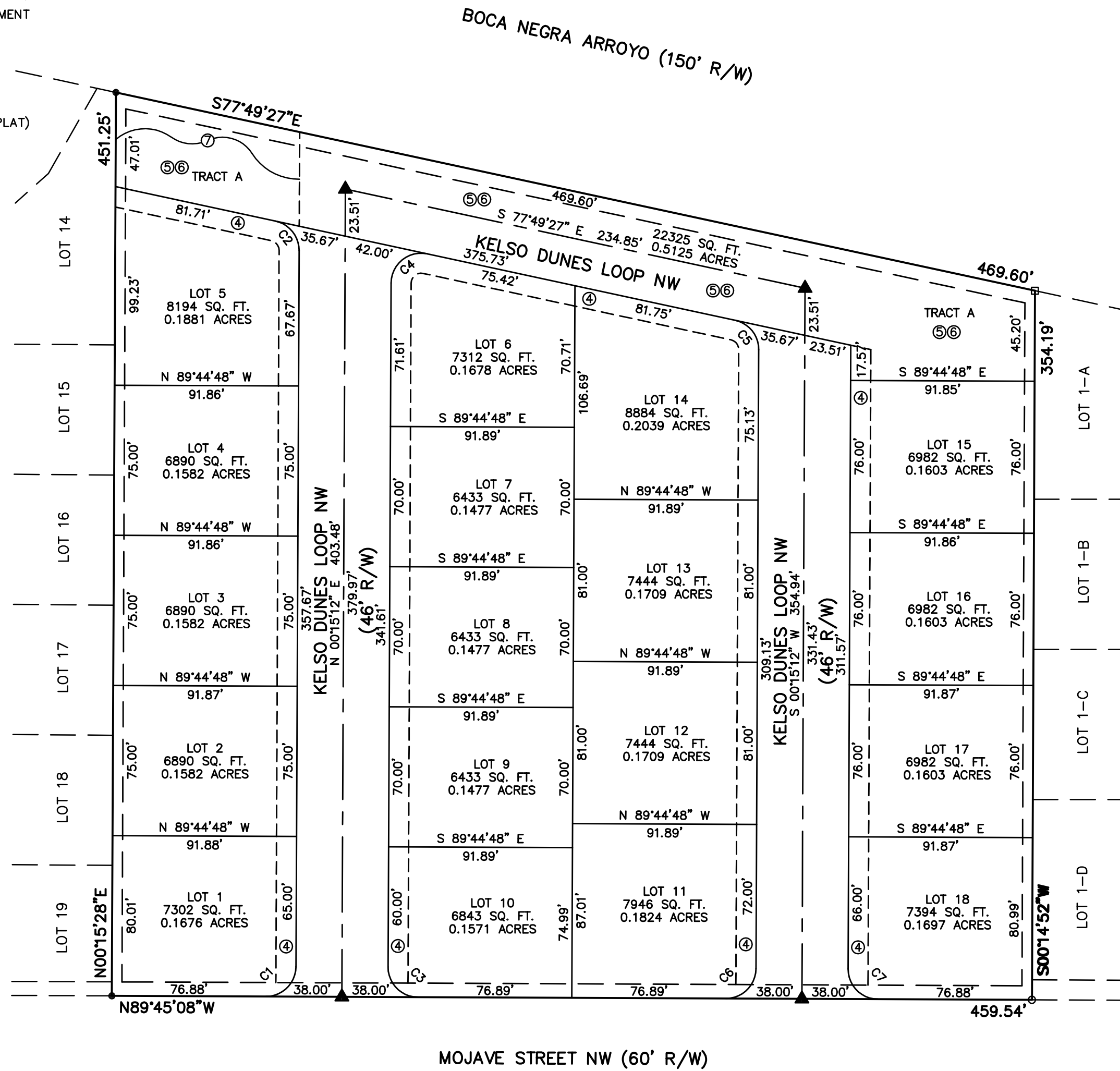

CURVE	RADIUS	ARC LENGTH	CHORD LENGTH	CHORD BEARING	DELTA ANGLE
C1	15.00'	23.56'	21.21'	N 45°15'02" E	89°59'40"
C2	15.00'	20.44'	18.90'	N 38°47'08" W	78°04'39"
C3	15.00'	23.56'	21.21'	N 44°44'58" W	90°00'20"
C4	15.00'	26.68'	23.30'	N 51°12'52" E	101°55'21"
C5	15.00'	20.44'	18.90'	S 38°47'08" E	78°04'39"
C6	15.00'	23.56'	21.21'	S 45°15'02" W	89°59'40"
C7	15.00'	23.56'	21.21'	N 44°44'58" W	90°00'20"

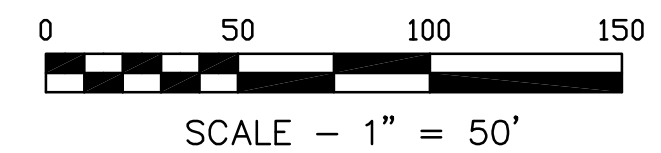

11-02-23 rev
 05-31-23 rev
 01-27-23 rev
 12-06-22 rev
 07-25-22 rev
 01-06-22 rev

Drawn By:	TA	Date:	01-02-22
Checked By:	TA	Drawing Name:	21090PLT.DWG
Job No.:	21-090	Sheet:	3 of 3



P.O. BOX 30701, ALBQ., N.M. 87190
 505-884-1990

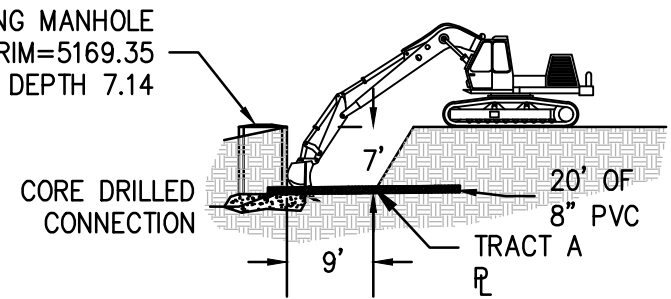
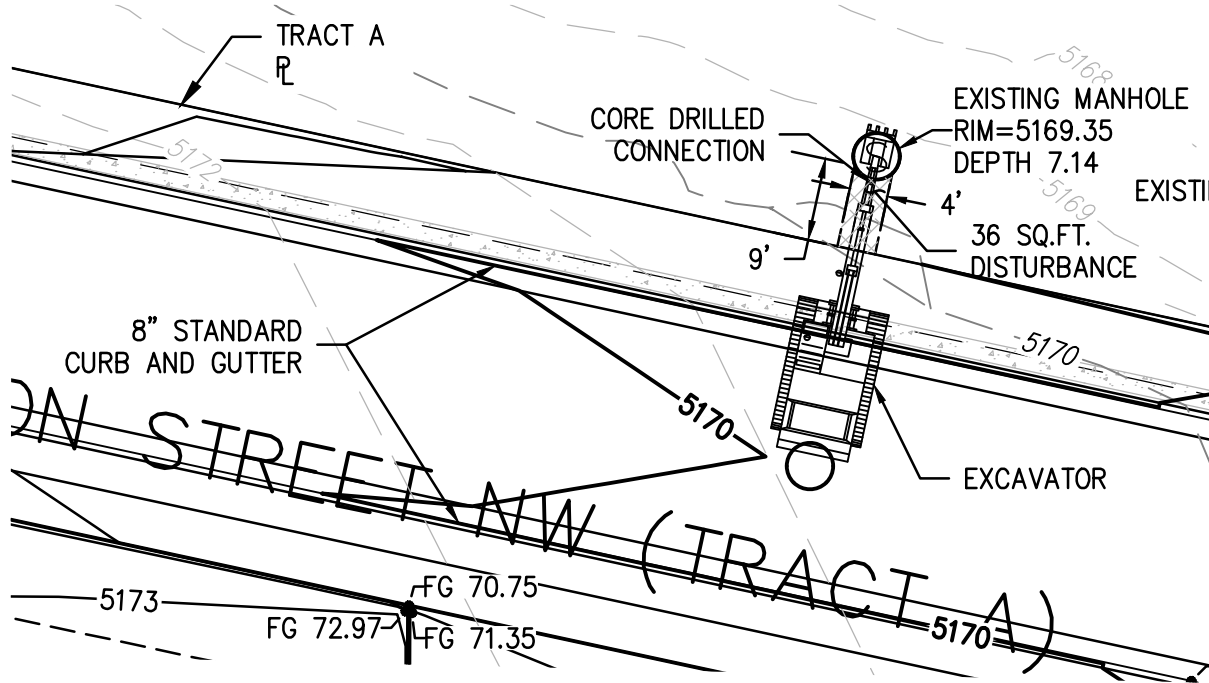
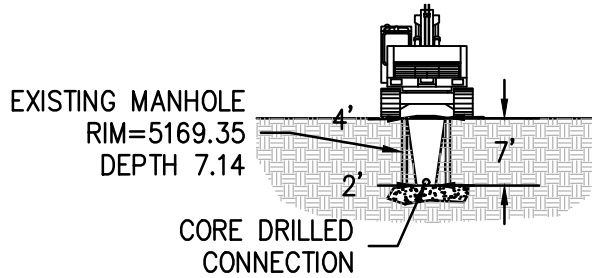

THE HENSLEY ENGINEERING GROUP
300 BRANDING IRON RD. SE
RIO RANCHO, NEW MEXICO 87124
Phone:(505) 410-1622

MOJAVE RIDGE SUBDIVISION
EXCAVATION EXIBHIT
SANITARY SEWER CONNECTION

SHEET 1 OF 1