



Proposed Sign Package
Albuquerque, NM 87114
10126 Coors Blvd. NW

05.24.2021

Revisions:

- R1- 05/25/2021 - ADDED OPTION 2, HEAD AT 8' FOR PYLON SIGN P1.**
- R2- 10/07/2021 - REPLACED ELEVATIONS**
- R3- 10/26/2021 - REPLACED SITE PLAN AND ELEVATIONS**
- R4- 01/28/2022 - REMOVED CHARACTERS FROM BUILDING ELEVATIONS**
- R5- 04/22/2022 - REVISED PYLON OPTIONS PER CLIENT**
- R6- 05/25/2022 - REMOVE M1, UPDATE P1**
- R7- 06/17/2022 - ADD P1 2ND OPTION**
- R8- 07/05/2022 - REVISE PYLON SIGN P1.**
- R9- 09/20/2022 - UPDATE SITE PLAN AND ELEVATIONS, REVISE SIGNS S2, S3 & S5.**

PRJ-PADA-163361-R9

COAST SIGN

1500 W. Embassy St. Anaheim, CA 92802 714.520.9144

Site Plan

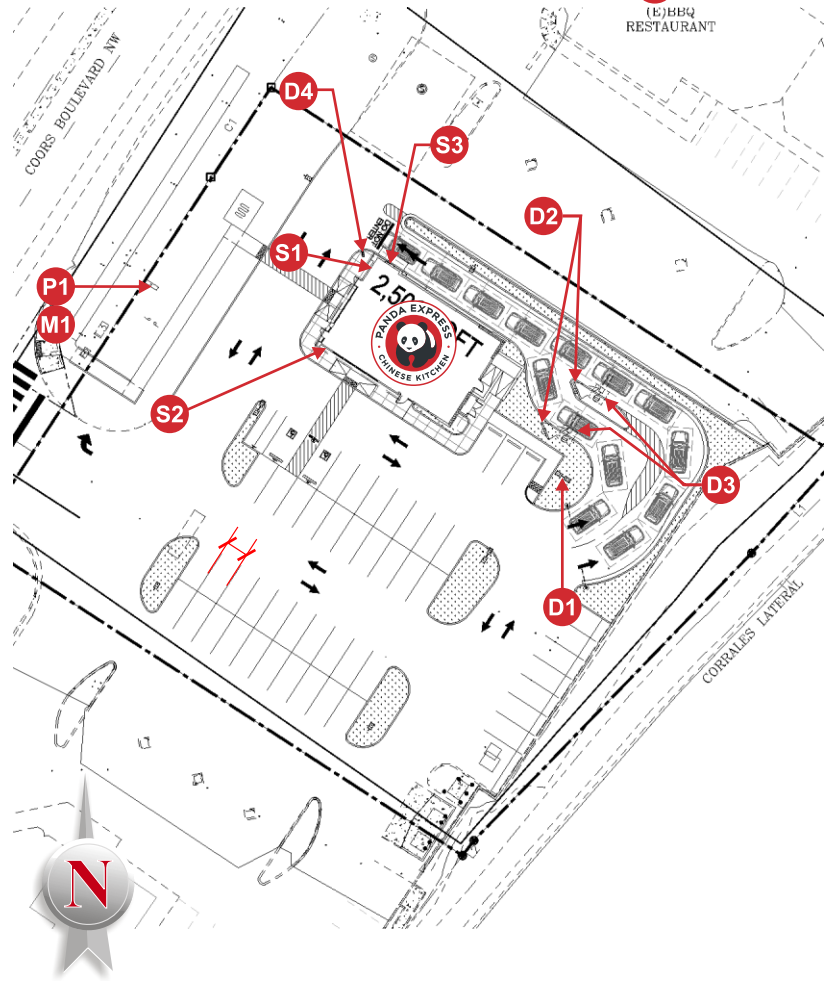

S1 24" Face Lit Stacked Channel Letters W/co Letters
(E)BBQ RESTAURANT



S2 S3 5'-0" Lock Up Logo

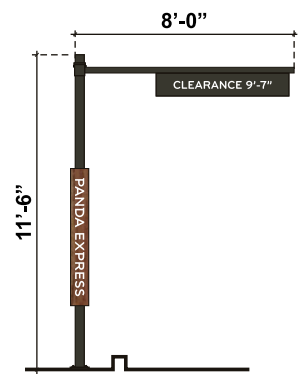

D1 DT Clearance Bar

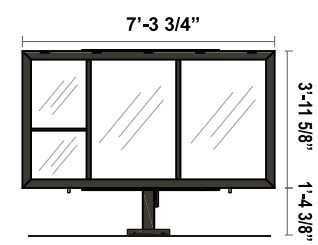

D2 DT Menu Board
QTY. (2)

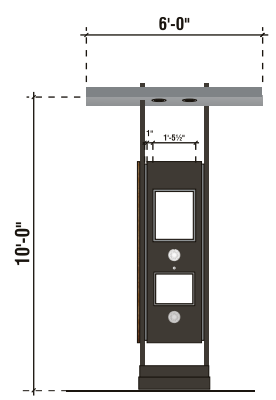

D3 DT COD Canopy
QTY. (2)



P1 Illuminated channel letters on panel
Existing Double Poles
Painted PMS Black 7C

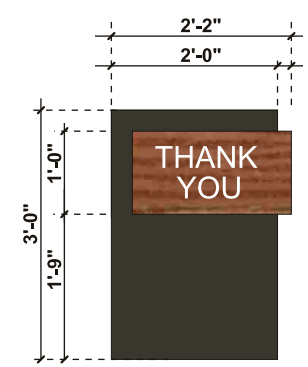

D4 Non-Illuminated Directional

Revisions:

R6-Remove M1, Update P1	ER
R7-Refer to Pathfinder	HA
R8-Refer to Pathfinder	HA
R9-Refer to Pathfinder	HA

CUSTOMER APPROVAL

Customer Signature	Date
--------------------	------

Date: 05-24-2021
Designer: JU PM: CM

City/State: Albuquerque, NM 87114
Address: 10126 Coors Blvd. NW

Drawing # **PRJ-PADA-163361**
Site Name **Albuquerque, NM**

Building Elevations



S1 24" Face Lit Stacked Channel Letters W/FCO Letters



FRONT ELEVATION - MAIN ENTRY

Scale: 1/8" = 1'-0"

Revisions:		
R6-Remove M1, Update P1	ER	
R7-Refer to Pathfinder	HA	
R8-Refer to Pathfinder	HA	
R9-Refer to Pathfinder	HA	

CUSTOMER APPROVAL	
Customer Signature _____	Date _____

Date: 05-24-2021

Designer: JU PM: CM

City/State: Albuquerque, NM 87114

Address: 10126 Coors Blvd. NW

Drawing # **PRJ-PADA-163361**

Site Name **Albuquerque, NM**

Building Elevations

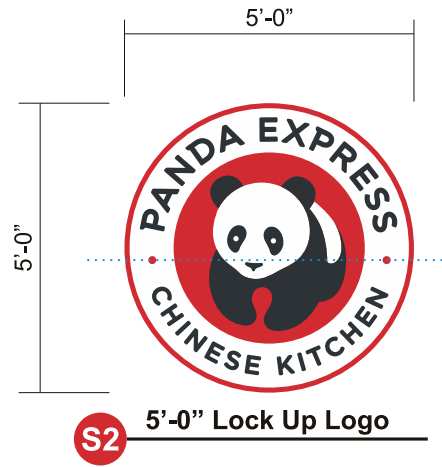

SIDE ELEVATION - SECONDARY ENTRY

Scale: 1/8" = 1'-0"

COAST SIGN
1500 W. Embassy St. Anaheim, CA 92802 714.520.9144

Revisions:		
R6-Remove M1, Update P1	ER	
R7-Refer to Pathfinder	HA	
R8-Refer to Pathfinder	HA	
R9-Refer to Pathfinder	HA	

CUSTOMER APPROVAL	
Customer Signature _____	Date _____

Date: 05-24-2021

Designer: JU PM: CM

City/State: Albuquerque, NM 87114

Address: 10126 Coors Blvd. NW

Drawing # **PRJ-PADA-163361**

Site Name **Albuquerque, NM**

Building Elevations

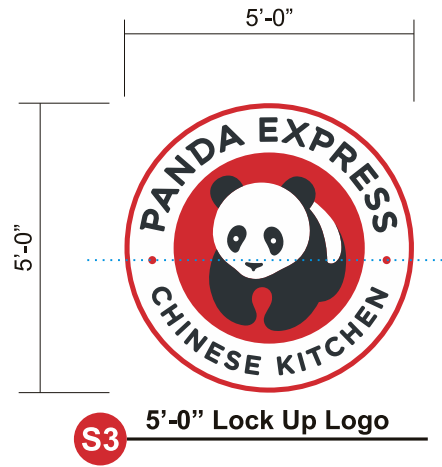

- TOP OF ROOF
20'-0" A.F.F.
- B.O. FIBERON BAND
16'-10" A.F.F.
- T.O. STOREFRONT
10'-0" A.F.F.
- T.O. STONE CAP
2'-6" A.F.F.
- FINISH FLOOR
0'-0" A.F.F.

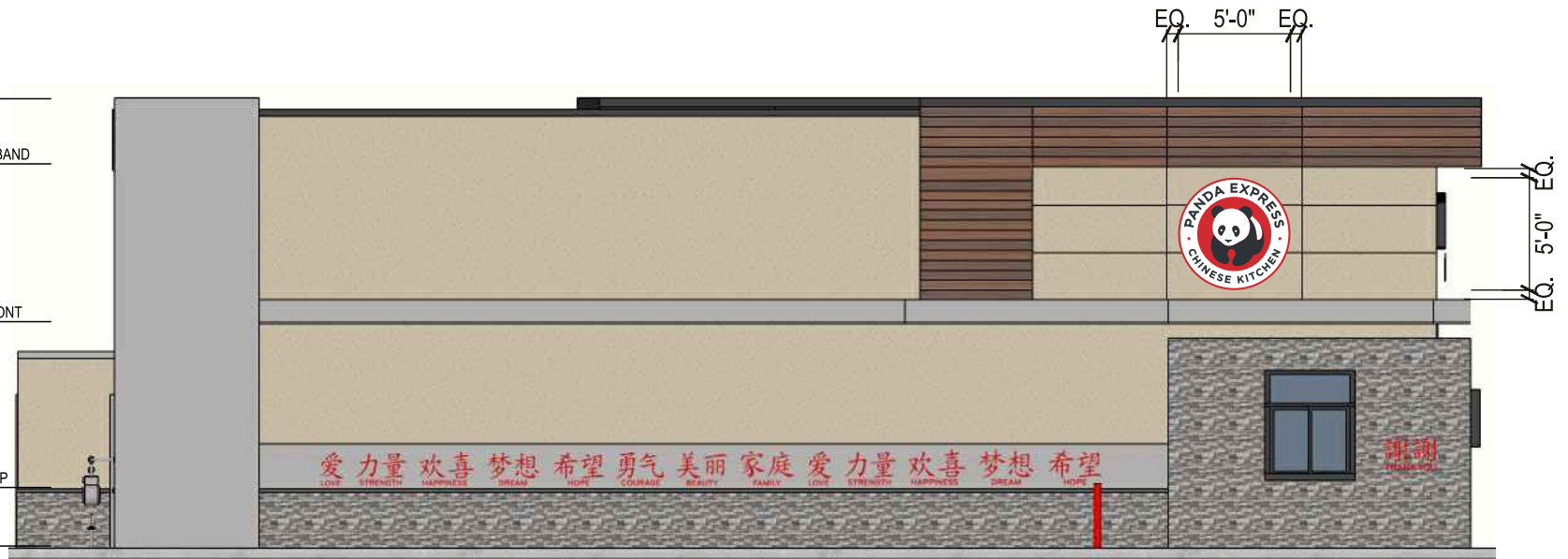

SIDE ELEVATION - DRIVE THRU SIDE

Scale: 1/8" = 1'-0"

COAST SIGN
1500 W. Embassy St. Anaheim, CA 92802 714.520.9144

Revisions:		
R6-Remove M1, Update P1	ER	
R7-Refer to Pathfinder	HA	
R8-Refer to Pathfinder	HA	
R9-Refer to Pathfinder	HA	

CUSTOMER APPROVAL	
Customer Signature _____	Date _____

Date: 05-24-2021

Designer: JU PM: CM





City/State: Albuquerque, NM 87114

Address: 10126 Coors Blvd. NW

Drawing # **PRJ-PADA-163361**

Site Name **Albuquerque, NM**

Building Elevations

-  TOP OF ROOF
20'-0" A.F.F.
-  B.O. FIBERON BAND
16'-10" A.F.F.
-  T.O. STOREFRONT
10'-0" A.F.F.
-  T.O. STONE CAP
2'-6" A.F.F.
-  FINISH FLOOR
0'-0" A.F.F.

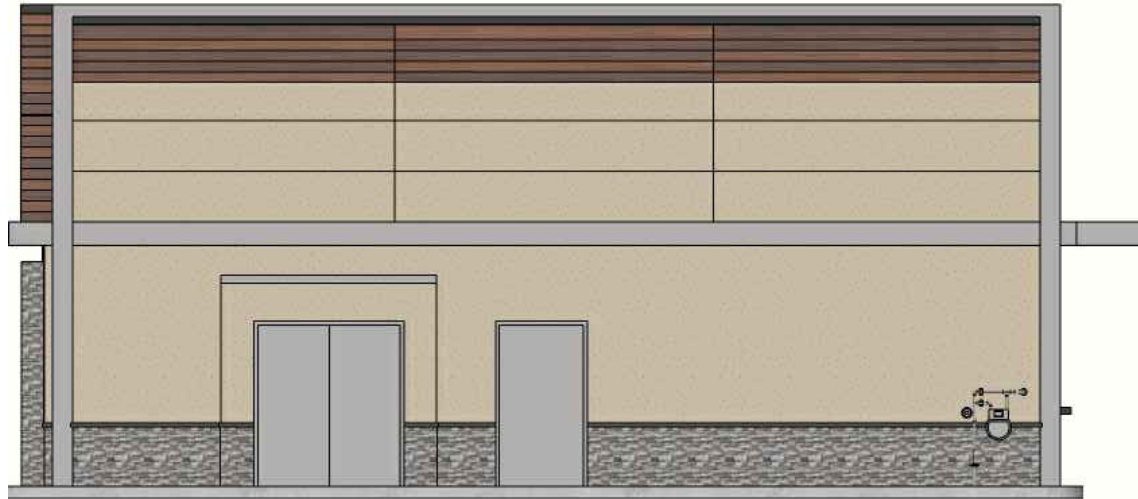

REAR ELEVATION

Scale: 1/8" = 1'-0"

Revisions:		
R6-Remove M1, Update P1	ER	
R7-Refer to Pathfinder	HA	
R8-Refer to Pathfinder	HA	
R9-Refer to Pathfinder	HA	

CUSTOMER APPROVAL	
Customer Signature _____	Date _____

Date: 05-24-2021

City/State: Albuquerque, NM 87114

Designer: JU PM: CM

Address: 10126 Coors Blvd. NW

Drawing # PRJ-PADA-163361
Site Name Albuquerque, NM

S1 Face Lit Channel Letters W/ FCO Letters (Qty: 1)

Install new face lit stacked channel letters.
Specifications Listed Below.



FACE LIT CHANNEL LETTERS SQ. FT.: 33.78

Scale: 1/2" = 1'-0"

NOTE: LIGHT BAR TO LIGHT UNDER EXPRESS ONLY

GENERAL SPECIFICATIONS:

FACE-LIT LETTERS:

- FACES:..... .177" WHITE #7328 ACRYLIC W/ 1ST SURFACE 3M #3630-33 RED
- TRIMCAP:... 1" BLACK TRIMCAP
- RETURNS:... .040" X 3" BLACK / WHITE COIL PAINTED TO MATCH BLACK 7C SATIN FINISH
- BACKS:..... .090" ALUMINUM BACK, INTERIOR PAINTED WHITE
- ILLUM'N:..... WHITE LED'S

BAR W/ FCO LETTERS:

- FACES:..... .177" WHITE #7328 ACRYLIC
- TRIMCAP:..... 1" WHITE TRIMCAP
- RETURNS:..... .125" X 3" FABRICATED RETURN PAINTED WHITE SATIN FINISH
- BACKS:..... .090" ALUMINUM BACK, INTERIOR PAINTED WHITE
- ILLUM'N:..... WHITE LED'S
- DOWNLIGHT: TBD
- EXPRESS:..... .25" FCO ALUMINUM LETTER PAINTED TO MATCH BLACK 7C SATIN FINISH

COLOR SPECIFICATIONS:

- ACRYLIC: .177" #7328 WHITE
- VINYL: 3M #3630-22 BLACK (STRIPS)
- PAINT: PMS BLACK 7C SATIN FINISH
- PAINT: AKZO PANDA RED, (AKZO SIGN 3762) SATIN FINISH
- VINYL: 3M #3630-33 RED

Revisions:

R6-Remove M1, Update P1	ER
R7-Refer to Pathfinder	HA
R8-Refer to Pathfinder	HA
R9-Refer to Pathfinder	HA

CUSTOMER APPROVAL	
Customer Signature _____	Date _____

Date: 05-24-2021
Designer: JU PM: CM

City/State: Albuquerque, NM 87114
Address: 10126 Coors Blvd. NW

Drawing # **PRJ-PADA-163361**
Site Name **Albuquerque, NM**

S2 S3

Face-Lit Lock Up Logo (Qty. 2)

Install new illuminated face-lit lock up logo. Flush Mounted.

GENERAL SPECIFICATIONS:

FACE-LIT LOGO:

FACES:..... .177" WHITE #7328 ACRYLIC WITH FIRST SURFACE VINYL
 TRIMCAP:... ALUMINUM RETAINER (SEE DETAILS BELOW)
 RETURNS:... .040" X 4" BLACK / WHITE COIL PAINTED TO MATCH BLACK 7C SATIN FINISH
 BACKS:..... ALUMINUM
 ILLUM'N:..... WHITE LED'S

COLOR SPECIFICATIONS:

- ACRYLIC: .177" #7328 WHITE
- VINYL: 3M #180-C-22 BLACK
- PAINT: PMS BLACK 7C SATIN FINISH
- VINYL: 3M #3630-33 RED

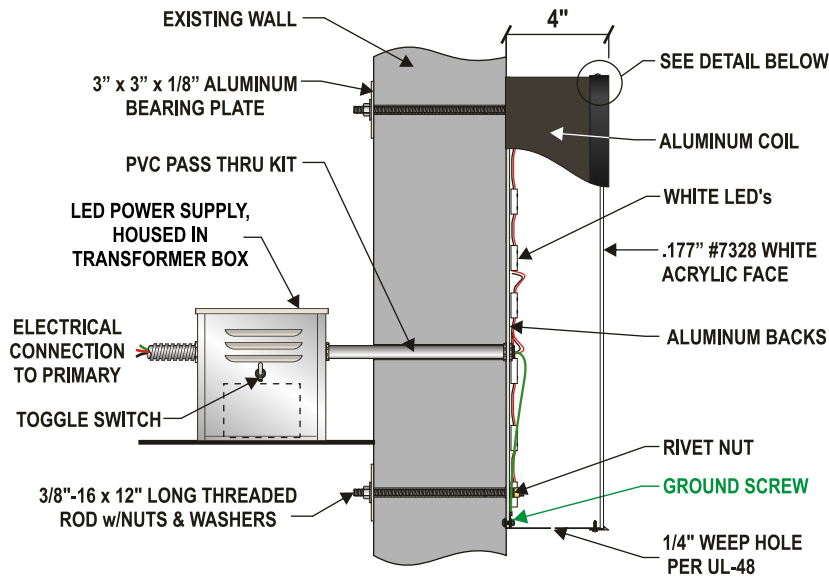

EXACT MANUFACTURING SPECIFICATIONS TO BE DETERMINED BY ENGINEERING DEPT.



A LOGO	B LOGO DEPTH	SQ. FT.
24"	4"	4
30"	4"	6.25
36"	4"	9
42"	4"	12.25
48"	4"	16
54"	4"	20.25
60"	4"	25
66"	4"	30.25
72"	4"	36

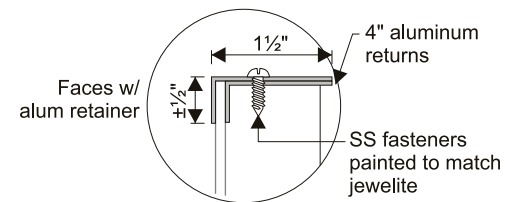

4'-0" AND OVER LOGO

P1 Face lit illuminated channel letters on panel (Qty. 2)

Install new Face lit illuminated channel letters on panel on existing cabinet. the Poles to be painted PMS black 7C. Specifications listed below.

- GENERAL SPECIFICATIONS:**
- LOGO:**
 FACES:.....0.177" WHITE ACRYLIC # 7328
 APPLIED ON FIRST SURFACE VINYL GRAPHICS
 3M# 3630-33 RED TRANSLUCENT VINYL
 3M # 7725-12 BLACK OPAQUE VINYL
 TRIMCAP:... 1" WHITE BRONZE #313
 RETURNS:.. 0.040" X 3.5" BRONZE #313 COIL
 BACKS:..... 3MM WHITE ACM
 ILLUM'N:..... WHITE AA LED'S
- LETTERS:**
 FACES:..... 0.177" WHITE ACRYLIC # 7328
 TRIMCAP:... 1" WHITE BRONZE #313
 RETURNS:.. 0.040" X 3.5" BRONZE #313 COIL
 BACKS:..... 3MM WHITE ACM
 ILLUM'N:..... WHITE AA LED'S
- BACKER PANEL (VERIFY):**
 FACES:..... 0.125" ALUM. PANEL
 PAINTED TO MATCH BLACK 7C SATIN FINISH
 RETURN.....2" X 2" X 1/8" ALUM. ANGLE FRAME TO BE GLUED
 TO BACK OF 0.125" ALUM. FACE W/
 LORDS STRUCTURAL ADHESIVE.
 PAINTED TO MATCH BLACK 7C SATIN FINISH

- COLOR SPECIFICATIONS:**
- ACRYLIC - 0.177" WHITE ACRYLIC # 7328
 - PAINT: PMS BLACK 7C SATIN FINISH
TRIMCAP: BRONZE #313
 - VYNYL : 3M # 7725-12 OPAQUE BLACK
 - VYNYL : 3M #3630-33 RED TRANSLUCENT

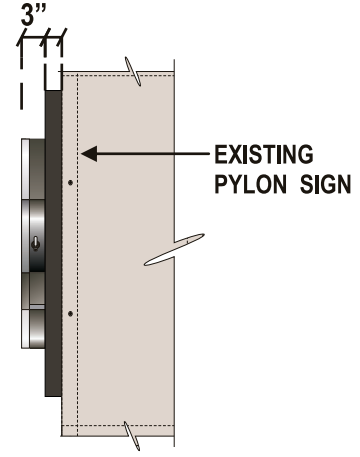

Face lit illuminated channel letters on panel
NTS

EXACT MANUFACTURING SPECIFICATIONS TO BE DETERMINED BY ENGINEERING DEPT.

D1

DT Clearance Bar (Qty. 1)

Install new DT Clearance Bar Sign. Refer to site plan for exact location.

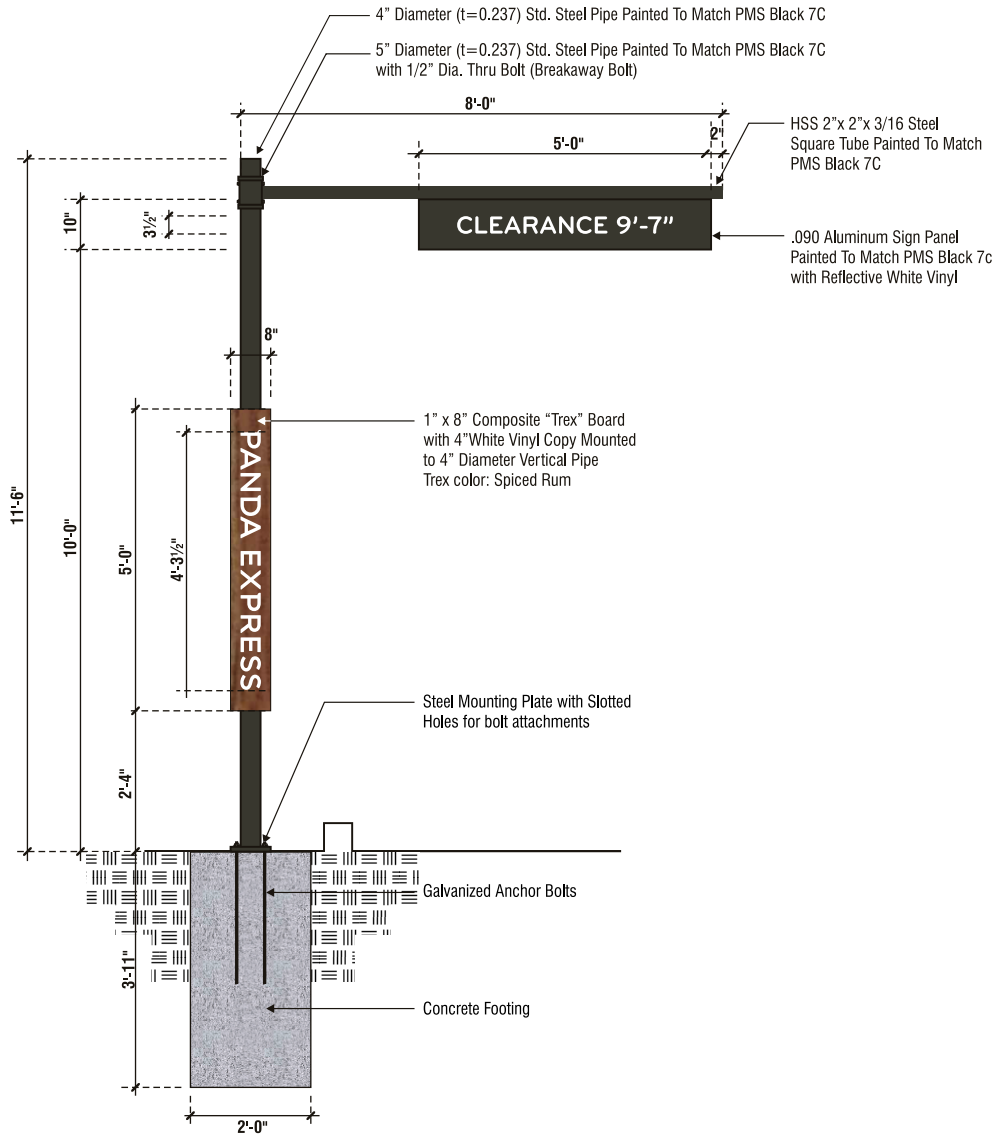

NON-ILLUMINATED CLEARANCE BAR

QUANTITY: ONE (1) SET REQUIRED

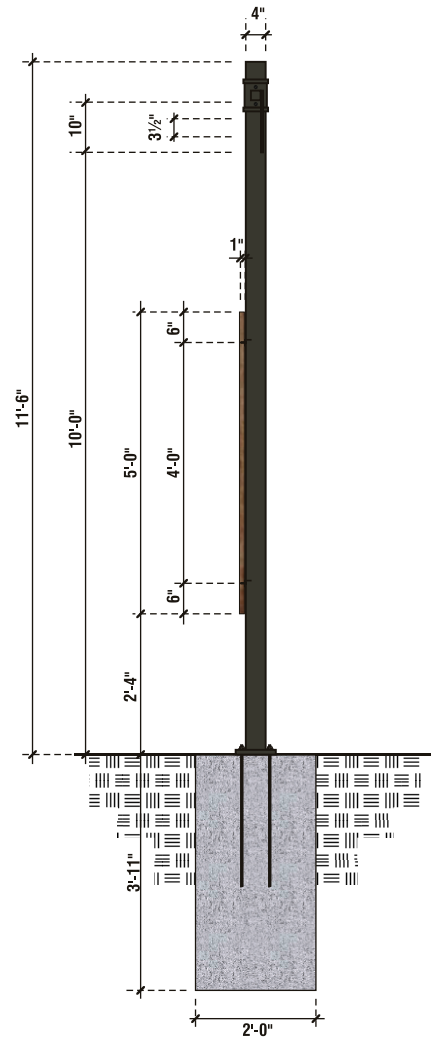

SIDE VIEW - NON-ILLUMINATED CLEARANCE BAR

D2

DT Menu Board (Qty. 2)

Install new DT Menu Board. Refer to site plan for exact location.

COLOR SPECIFICATIONS

MAIN CABINET

Painted to match PMS Black 7C

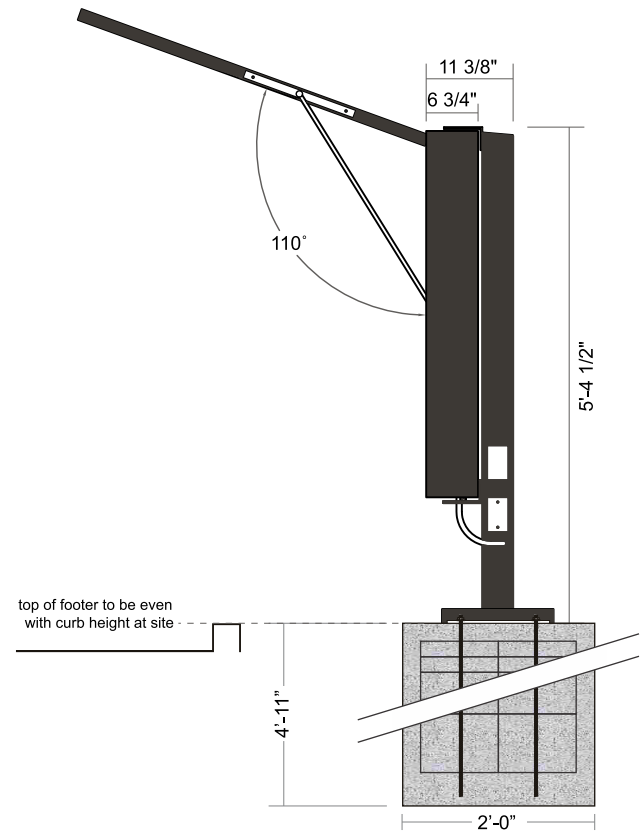
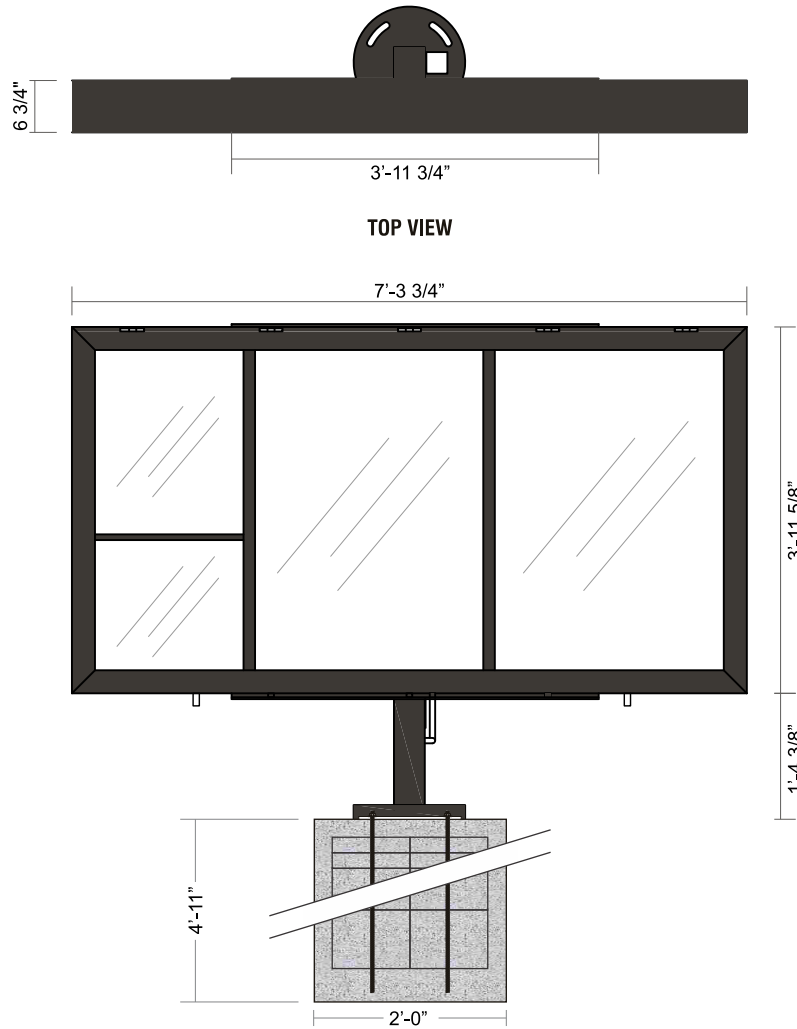

FRONT VIEW - MENU BOARD - SCALE: 1/2" = 1'-0"

SIDE VIEW

Revisions:		
R6-Remove M1, Update P1	ER	
R7-Refer to Pathfinder	HA	
R8-Refer to Pathfinder	HA	
R9-Refer to Pathfinder	HA	

CUSTOMER APPROVAL	
Customer Signature _____	Date _____

Date: 05-24-2021

Designer: JU PM: CM

City/State: Albuquerque, NM 87114

Address: 10126 Coors Blvd. NW

Drawing # **PRJ-PADA-163361**

Site Name **Albuquerque, NM**

D3

DT COD Canopy (Qty. 2)

Install new DT COD Canopy. Refer to site plan for exact location.

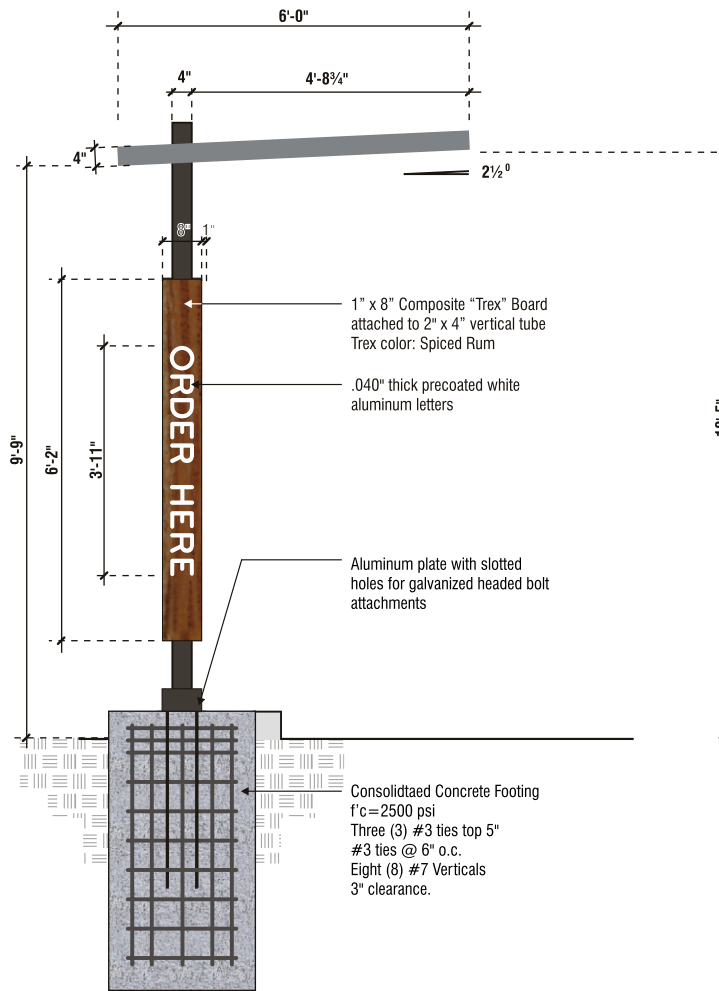

COD CANOPY - ILLUMINATED

QUANTITY: ONE (1) SET REQUIRED

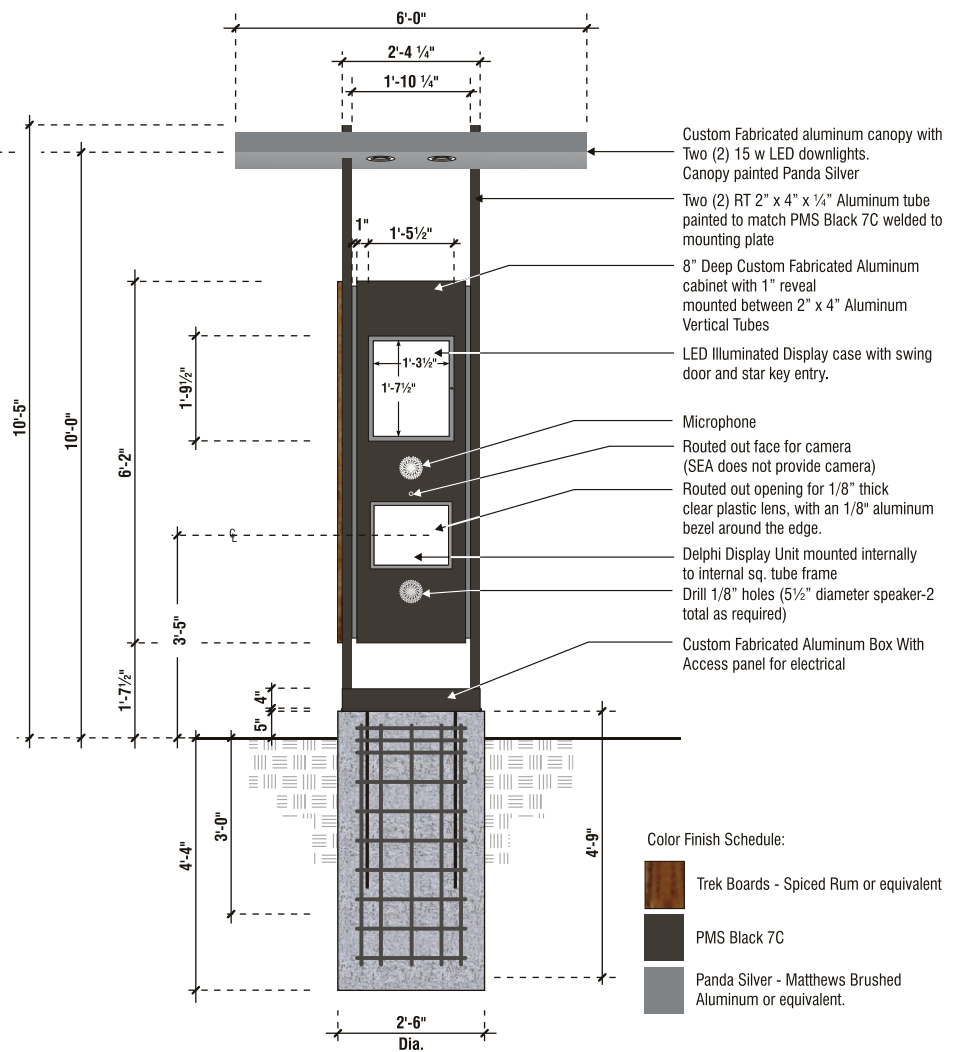

FRONT VIEW - COD CANOPY (DRIVE WAY SIDE)

D4

Non-Illuminated D/F Directional (Qty. 1)

Install new non-illuminated directional. Refer to site plan for exact location.

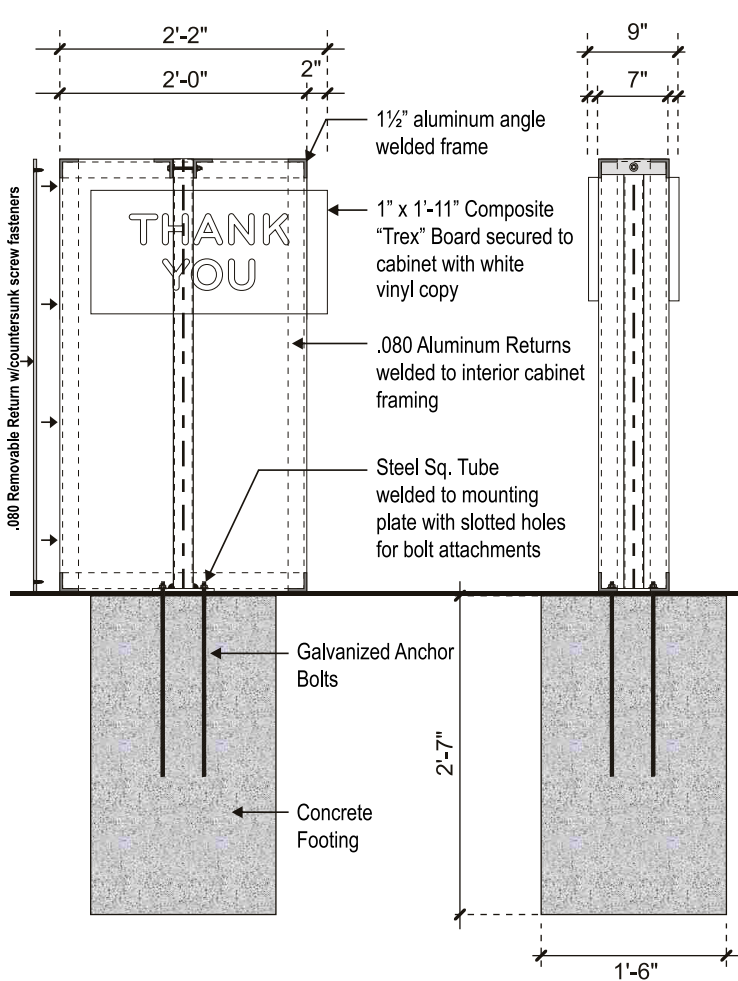

CUSTOM FABRICATED NON-ILLUMINATED DIRECTIONAL

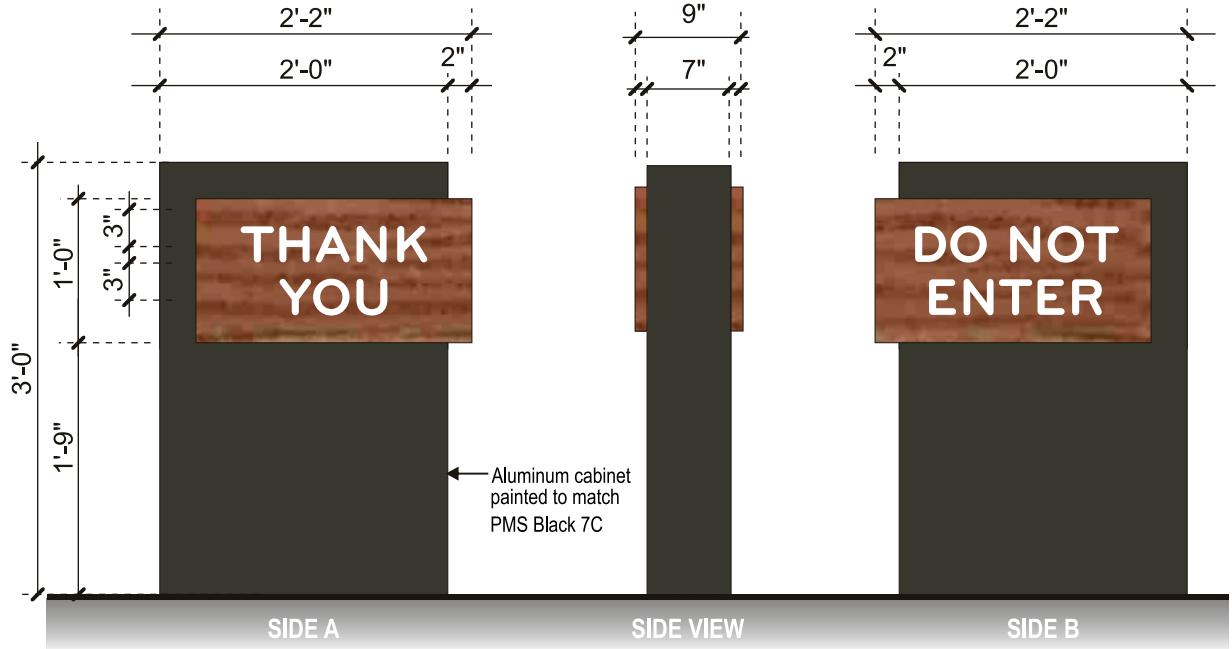

NON-ILLUMINATED DOUBLE FACE DIRECTIONAL SIGN

QUANTITY: ONE (1) REQUIRED

SCALE: 3/4" = 1'-0"

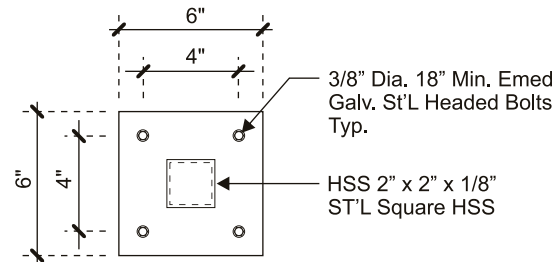

BASE PLATE

SCALE: 1 1/2" = 1'-0"

Revisions:		
R6-Remove M1, Update P1	ER	
R7-Refer to Pathfinder	HA	
R8-Refer to Pathfinder	HA	
R9-Refer to Pathfinder	HA	

CUSTOMER APPROVAL	
Customer Signature _____	Date _____

Date: 05-24-2021
Designer: JU PM: CM

City/State: Albuquerque, NM 87114
Address: 10126 Coors Blvd. NW

Drawing # **PRJ-PADA-163361**
Site Name **Albuquerque, NM**