

Stormwater Pollution Prevention Plan (SWPPP)

For Construction Activities At:

Take 5 Oil Change
2030 Gibson Boulevard SE
Albuquerque, New Mexico 87108

SWPPP Prepared For:

Durban Development
Stephen Knudsen
106 Foster Avenue
Charlotte, NC 28203
704-319-8346
Stephen.Knudsen@DurbanDevelopment.com

SWPPP Prepared By:

Galloway & Company, LLC
Troy Kelts
5500 Greenwood Plaza Blvd., Suite 200
Greenwood Village, CO 80111
303-770-8884
TroyKelts@GallowayUS.com

SWPPP Preparation Date:

12/22/2025

Estimated Project Dates:

Project Start Date: 01/26/2026

Project Completion Date: 06/29/2026

Contents

SECTION 1: CONTACT INFORMATION/RESPONSIBLE PARTIES1

1.1 Operator(s) / Subcontractor(s)1

1.2 Stormwater Team2

SECTION 2: SITE EVALUATION, ASSESSMENT, AND PLANNING4

2.1 Project/Site Information4

2.2 Discharge Information.....4

2.3 Nature of the Construction Activities.....5

2.4 Sequence and Estimated Dates of Construction Activities7

2.5 Authorized Non-Stormwater Discharges8

2.6 Site Maps.....9

SECTION 3: DOCUMENTATION OF COMPLIANCE WITH OTHER FEDERAL REQUIREMENTS10

3.1 Endangered Species Protection10

3.2 Historic Property Screening Process13

3.3 Safe Drinking Water Act Underground Injection Control Requirements ...14

SECTION 4: EROSION AND SEDIMENT CONTROLS AND DEWATERING PRACTICES ...16

4.1 Natural Buffers or Equivalent Sediment Controls16

4.2 Perimeter Controls18

4.3 Sediment Track-Out19

4.4 Stockpiles or Land Clearing Debris Piles Comprised of Sediment or Soil ...20

4.5 Minimize Dust.....20

4.6 Minimize Steep Slope Disturbances.....21

4.7 Topsoil.....21

4.8 Soil Compaction21

4.9 Storm Drain Inlets.....22

4.10 Constructed Site Drainage Feature22

4.11 Sediment Basins or Similar Impoundments23

4.12 Chemical Treatment.....23

4.13 Dewatering Practices.....24

4.14 Other Stormwater Controls24

4.15 Site Stabilization.....25

SECTION 5: POLLUTION PREVENTION CONTROLS28

5.1 Potential Sources of Pollution28

5.2 Spill Prevention and Response28

5.3 Fueling and Maintenance of Equipment or Vehicles29

5.4 Washing of Equipment and Vehicles.....29

5.5 Storage, Handling, and Disposal of Building Products, Materials, and Wastes 29

5.6 Washing of Applicators and Containers used for Stucco, Paint, Concrete, Form Release Oils, Cutting Compounds, or Other Materials31

5.7 Application of Fertilizers32

5.8 Other Pollution Prevention Practices32

SECTION 6: INSPECTION, MAINTENANCE, AND CORRECTIVE ACTION.....33

6.1 Inspection Personnel and Procedures.....33

6.2 Corrective Action35

6.3 Delegation of Authority35

SECTION 7: TURBIDITY BENCHMARK MONITORING FOR DEWATERING DISCHARGES
.....36

SECTION 8: CERTIFICATION AND NOTIFICATION.....37

SWPPP APPENDICES38

SECTION 1: CONTACT INFORMATION/RESPONSIBLE PARTIES

1.1 Operator(s) / Subcontractor(s)

Operator(s):

Durban Development
Stephen Knudsen
106 Foster Avenue
Charlotte, NC 28203
704-319-8346
Stephen.Knudsen@DurbanDevelopment.com

Subcontractor(s):

White Sands Construction, Inc.
Tyrel Parker
1700 E 10th St A
Alamogordo, NM 88310
575-408-2121
tyrel@whitesandsconstruction.com

White Sands Construction, Inc.
Ethan Schulz
1700 E 10th St A
Alamogordo, NM 88310
575-415-2166
ethanschulz@whitesandsconstruction.com

Emergency 24-Hour Contact:

White Sands Construction, Inc.
Tyrel Parker
575-408-2121

1.2 Stormwater Team

Stormwater Team

Name and/or Position, and Contact	Responsibilities	I Have Completed Training Required by CGP Part 6.2	I Have Read the CGP and Understand the Applicable Requirements
Troy Kelts Sr. Civil Engineer Project Manager 303-770-8884 TroyKelts@GallowayUS.com	Civil Engineer	<input type="checkbox"/> Yes <input type="checkbox"/> No	<input checked="" type="checkbox"/> Yes Date: 12/22/2025
Tyrel Parker Project Manager 575-408-2121 Tyrel@WhiteSandsConstruction.com	Contractor	<input checked="" type="checkbox"/> Yes <input type="checkbox"/> No	<input checked="" type="checkbox"/> Yes Date: 12/22/2025
Ethan Schulz Inspector 575-415-2166 EthanSchulz@WhiteSandsConstruction.com	Inspections	<input checked="" type="checkbox"/> Yes <input type="checkbox"/> No	<input checked="" type="checkbox"/> Yes Date: 12/22/2025

Stormwater Team Members Who Conduct Inspections Pursuant to CGP Part 4

Name and/or Position and Contact	Training(s) Received	Date Training(s) Completed	If Training is a Non-EPA Training, Confirm that it Satisfies the Minimum Elements of CGP Part 6.3.b
<p>Ethan Schulz Inspector 575-415-2166 EthanSchulz@WhiteSandsConstruction.com</p>	<p>Storm Water Pollution Prevention Plan Training for Owners and Inspectors</p>	<p>Date: 3/4/2022</p>	<p><input checked="" type="checkbox"/> Principles and practices of erosion and sediment control and pollution prevention practices at construction sites</p> <p><input checked="" type="checkbox"/> Proper installation and maintenance of erosion and sediment controls and pollution prevention practices used at construction sites</p> <p><input checked="" type="checkbox"/> Performance of inspections, including the proper completion of required reports and documentation, consistent with the requirements of Part 4</p>

SECTION 2: SITE EVALUATION, ASSESSMENT, AND PLANNING

2.1 Project/Site Information

Project Name and Address

Project/Site Name: [Take 5 Oil Change](#)

Street/Location: [2030 Gibson Boulevard SE](#)

City: [Albuquerque](#)

State: [New Mexico](#),

ZIP Code: [87106](#)

County or Similar Government Division: [Bernalillo County](#)

Project Latitude/Longitude

Latitude: [35.057685](#)° N

(decimal degrees)

Longitude: - [106.624529](#) ° W

(decimal degrees)

Latitude/longitude data source: Map GPS Other (please specify): Google Earth

Horizontal Reference Datum: NAD 27 NAD 83 WGS 84

Additional Site Information

Is your site located on Indian country lands, or on a property of religious or cultural significance to an Indian Tribe? Yes No

If yes, provide the name of the Indian Tribe associated with the area of Indian country (including the name of Indian reservation if applicable), or if not in Indian country, provide the name of the Indian Tribe associated with the property: [N/A](#)

2.2 Discharge Information

Does your project/site discharge stormwater into a Municipal Separate Storm Sewer System (MS4)? Yes No

Are there any waters of the U.S. within 50 feet of your project's earth disturbances? Yes No

For each point of discharge, provide a point of discharge ID (a unique 3-digit ID, e.g., 001, 002), the name of the first receiving water that receives stormwater directly from the point of discharge and/or from the MS4 that the point of discharge discharges to, and the following receiving water information, if applicable:

Point of Discharge ID	Name of receiving water that receives stormwater discharge:	Is the receiving water impaired (on the CWA 303(d) list)?	If yes, list the pollutants that are causing the impairment:	Has a TMDL been completed for this receiving waterbody?	If yes, list TMDL Name and ID:	Pollutant(s) for which there is a TMDL:	Is this receiving water designated as a Tier 2, Tier 2.5, or Tier 3 water?	If yes, specify which Tier (2, 2.5, or 3)?
17806412	Unidentified Water	<input type="checkbox"/> Yes <input checked="" type="checkbox"/> No		<input type="checkbox"/> Yes <input checked="" type="checkbox"/> No			<input type="checkbox"/> Yes <input checked="" type="checkbox"/> No	N/A
17806486	Unnamed Tributary (South Diversion Channel to I-25) (NM-97.A_015)	<input type="checkbox"/> Yes <input checked="" type="checkbox"/> No		<input type="checkbox"/> Yes <input checked="" type="checkbox"/> No			<input type="checkbox"/> Yes <input checked="" type="checkbox"/> No	N/A

2.3 Nature of the Construction Activities

General Description of Project

Provide a general description of the nature of your construction activities, including the age or dates of past renovations for structures that are undergoing demolition:

The project located on an 0.42 undeveloped lot will include vertical construction of the drive-through oil change building, water quality ponds, wet and dry utility service lines, trash enclosure, asphalt pavement, and concrete sidewalk. The entirety of the property is expected to be disturbed to install the improvements. The adjacent properties are established commercial properties with existing infrastructure in place.

If you are conducting earth-disturbing activities in response to a public emergency, document the cause of the public emergency (*e.g., mud slides, earthquake, extreme flooding conditions, widespread disruption in essential public services*), information substantiating its occurrence (*e.g., State disaster declaration or similar State or local declaration*), and a description of the construction necessary to reestablish affected public services:

N/A

Business days and hours for the project: Monday – Friday, 7a.m. – 7p.m.

Size of Construction Site

Size of Property	0.42 acres
Total Area Expected to be Disturbed by Construction Activities	0.42 acres
Maximum Area Expected to be Disturbed at Any One Time, Including On-site and Off-site Construction Support Areas	0.42 acres

[Repeat as necessary for individual project phases.]

Type of Construction Site (check all that apply):

- Single-Family Residential
 Multi-Family Residential
 Commercial
 Industrial
 Institutional
 Highway or Road
 Utility
 Other _____

Will you be discharging dewatering water from your site? Yes No

If yes, will you be discharging dewatering water from a current or former Federal or State remediation site? Yes No

Pollutant-Generating Activities

List and describe all pollutant-generating activities and indicate for each activity the associated pollutants or pollutant constituents that could be discharged in stormwater from your construction site. Take into account where potential spills and leaks could occur that contribute pollutants to stormwater discharges, and any known hazardous or toxic substances, such as PCBs and asbestos, that will be disturbed during construction.

Pollutant-Generating Activity	Pollutants or Pollutant Constituents
(e.g., paving operations; concrete, paint, and stucco washout and waste disposal; solid waste storage and disposal; and dewatering operations)	(e.g., sediment, fertilizers, pesticides, paints, caulks, sealants, fluorescent light ballasts, contaminated substrates, solvents, fuels)
Disturbed and Stored Soils	Sediment
Vehicle Tracking of Sediments	Insert Pollutant(s)
Outdoor Storage Area	Paint, fuel, form oil, hydraulic fluid, plumbing glue, fertilizer
Fueling/Maintenance of Vehicles/Equipment	Fuel, oil, hydraulic fluid, detergents, solvents
Concrete Truck/Equipment Washing	Concrete, Sediment
Solid Waste Storage and Disposal	Trash/Debris, portable toilets

[Include additional rows or delete as necessary.]

Construction Support Activities *(only provide if applicable)*

Describe any construction support activities for the project (e.g., concrete or asphalt batch plants, equipment staging yards, material storage areas, excavated material disposal areas, borrow areas):

One stabilized staging area will be utilized onsite to facilitate construction. Concrete and asphalt are expected to be delivered to the site.

Contact information for construction support activity:

Tyrel Parker
 Project Manager
 575-408-2121
Tyrel@WhiteSandsConstruction.com

2.4 Sequence and Estimated Dates of Construction Activities

Phase I

Initial – Set up Controls, Demolition	
Estimated Start Date of Construction Activities for this Phase	3/2/2026
Estimated End Date of Construction Activities for this Phase	3/23/2026
Estimated Date(s) of Application of Stabilization Measures for Areas of the Site Required to be Stabilized	3/23/2026 [Add additional dates as necessary]
Estimated Date(s) when Stormwater Controls will be Removed	7/31/2026 [Add additional dates as necessary]

Phase II

Interim – Rough Grading, Utilities, Building	
Estimated Start Date of Construction Activities for this Phase	3/23/2026
Estimated End Date of Construction Activities for this Phase	5/4/2026
Estimated Date(s) of Application of Stabilization Measures for Areas of the Site Required to be Stabilized	5/4/2026 [Add additional dates as necessary]
Estimated Date(s) when Stormwater Controls will be Removed	7/31/2026 [Add additional dates as necessary]

Phase III

Final – Paving & Stabilization	
Estimated Start Date of Construction Activities for this Phase	5/4/2026

Estimated End Date of Construction Activities for this Phase	7/31/2026
Estimated Date(s) of Application of Stabilization Measures for Areas of the Site Required to be Stabilized	7/31/2026 [Add additional dates as necessary]
Estimated Date(s) when Stormwater Controls will be Removed	7/31/2026 [Add additional dates as necessary]

2.5 Authorized Non-Stormwater Discharges

List of Authorized Non-Stormwater Discharges Present at the Site

Authorized Non-Stormwater Discharge	Will or May Occur at Your Site?
Discharges from emergency fire-fighting activities	<input checked="" type="checkbox"/> Yes <input type="checkbox"/> No
Fire hydrant flushings	<input checked="" type="checkbox"/> Yes <input type="checkbox"/> No
Landscape irrigation	<input checked="" type="checkbox"/> Yes <input type="checkbox"/> No
Water used to wash vehicles and equipment	<input checked="" type="checkbox"/> Yes <input type="checkbox"/> No
Water used to control dust	<input checked="" type="checkbox"/> Yes <input type="checkbox"/> No
Potable water including uncontaminated water line flushings	<input checked="" type="checkbox"/> Yes <input type="checkbox"/> No
External building washdown (soaps/solvents are not used and external surfaces do not contain hazardous substances)	<input checked="" type="checkbox"/> Yes <input type="checkbox"/> No
Pavement wash waters	<input checked="" type="checkbox"/> Yes <input type="checkbox"/> No
Uncontaminated air conditioning or compressor condensate	<input type="checkbox"/> Yes <input checked="" type="checkbox"/> No
Uncontaminated, non-turbid discharges of ground water or spring water	<input type="checkbox"/> Yes <input checked="" type="checkbox"/> No
Foundation or footing drains	<input type="checkbox"/> Yes <input checked="" type="checkbox"/> No
Uncontaminated construction dewatering water	<input type="checkbox"/> Yes <input checked="" type="checkbox"/> No

2.6 Site Maps

See Appendix A

SECTION 3: DOCUMENTATION OF COMPLIANCE WITH OTHER FEDERAL REQUIREMENTS

3.1 Endangered Species Protection

Eligibility Criterion

Following the process outlined in Appendix D, under which criterion are you eligible for coverage under this permit?

- Criterion A:** No ESA-listed species and/or designated critical habitat present in action area. Using the process outlined in Appendix D of the CGP, you certify that ESA-listed species and designated critical habitat(s) under the jurisdiction of the USFWS or NMFS are not likely to occur in your site's "action area" as defined in Appendix A of the CGP. *Please Note: NMFS' jurisdiction includes ESA-listed marine and estuarine species that spawn in inland rivers.*
- Check to confirm you have provided documentation in your SWPPP as required by CGP Appendix D (Note: reliance on State resources is not acceptable; see CGP Appendix D).

Documentation: [Insert Text Here](#)

- Criterion B:** Eligibility requirements met by another operator under the 2022 CGP. The construction site's discharges and discharge-related activities were already addressed in another operator's valid certification of eligibility for your "action area" under eligibility Criterion A, C, D, E, or F of the 2022 CGP and you have confirmed that no additional ESA-listed species and/or designated critical habitat under the jurisdiction of USFWS and/or NMFS not considered in the that certification may be present or located in the "action area." To certify your eligibility under this criterion, there must be no lapse of NPDES permit coverage in the other CGP operator's certification. By certifying eligibility under this criterion, you agree to comply with any conditions upon which the other CGP operator's certification was based. You must include in your NOI the NPDES ID from the other 2022 CGP operator's notification of authorization under this permit and list any measures that you must comply with. If your certification is based on another 2022 CGP operator's certification under criterion C, you must provide EPA with the relevant supporting information required of existing dischargers in Criterion C.
- Check to confirm you have provided documentation in your SWPPP as required by CGP Appendix D.

Documentation: [Insert Text Here](#)

Eligibility Criterion

Following the process outlined in Appendix D, under which criterion are you eligible for coverage under this permit?

- Criterion C:** Discharges not likely to result in any short- or long-term adverse effects to ESA-listed species and/or designated critical habitat. ESA-listed species and/or designated critical habitat(s) under the jurisdiction of the USFWS and/or NMFS are likely to occur in or near your site's "action area," and you certify to EPA that your site's discharges and discharge-related activities are not likely to result in any short- or long-term adverse effects to ESA-listed threatened or endangered species and/or designated critical habitat. This certification may include consideration of any stormwater controls and/or management practices you will adopt to ensure that your discharges and discharge-related activities are not likely to result in any short- or long-term adverse effects to ESA-listed species and/or designated critical habitat. To certify your eligibility under this criterion, indicate 1) the ESA-listed species and/or designated habitat located in your "action area" using the process outlined in Appendix D of this permit; 2) the distance between the site and the listed species and/or designated critical habitat in the action area (in miles); and 3) a rationale describing specifically how short- or long-term adverse effects to ESA-listed species will be avoided from the discharges and discharge-related activities. (Note: You must include a copy of your site map from your SWPPP showing the upland and in-water extent of your "action area" with your NOI.)
- Check to confirm you have provided documentation in your SWPPP as required by CGP Appendix D.

Documentation: [See Appendix K](#)

- Criterion D:** Coordination with USFWS and/or NMFS has successfully concluded. Coordination between you and the USFWS and/or NMFS has concluded. The coordination must have addressed the effects of your site's discharges and discharge-related activities on ESA-listed species and/or designated critical habitat under the jurisdiction of USFWS and/or NMFS, and resulted in a written confirmation from USFWS and/or NMFS that the effects of your site's discharges and discharge-related activities are not likely to result in any short- or long-term adverse effects. By certifying eligibility under this criterion, you agree to comply with any conditions you must meet for your site's discharges and discharge-related activities to not likely result in any short- or long-term adverse effects. You must include copies of the correspondence with the participating agencies in your SWPPP and this NOI.
- Check to confirm you have provided documentation in your SWPPP as required by CGP Appendix D.

Documentation: [Insert Text Here](#)

Eligibility Criterion

Following the process outlined in Appendix D, under which criterion are you eligible for coverage under this permit?

- Criterion E: ESA Section 7 consultation has successfully concluded.** Consultation between a Federal agency and the USFWS and/or NMFS under section 7 of the ESA has concluded. Consultations can be either formal or informal, and would have occurred only as a result of a separate Federal action (e.g., during application for an individual wastewater discharge permit or the issuance of a wetlands dredge and fill permit), and the consultation must have addressed the effects of your construction activity's discharges and discharge-related activities on all ESA-listed threatened or endangered species and all designated critical habitat under the jurisdiction of each Service, as appropriate, in your action area. The result of this consultation must be either:
- i. A biological opinion currently in effect that determined that the action in question (taking into account the effects of your facility's discharges and discharge-related activities) is likely to adversely affect, but is not likely to jeopardize the continued existence of listed species or result in the destruction or adverse modification of critical habitat. The biological opinion must have included the effects of your facility's discharges and discharge-related activities on all the listed species and designated critical habitat in your action area under the jurisdiction of each Service, as appropriate. To be eligible under (i), any reasonable and prudent measures specified in the incidental take statement must be implemented;
 - ii. Written concurrence (e.g., letter of concurrence) from the applicable Service(s) with a determination that your facility's discharges and discharge-related activities are not likely to adversely affect ESA-listed species and/or designated critical habitat. The concurrence letter must have included the effects of your facility's discharges and discharge-related activities on all the ESA-listed species and/or designated critical habitat on your species list(s) acquired from USFWS and/or NMFS as part of this worksheet.

The consultation does not warrant reinitiation under 50 CFR §402.16; or, if reinitiation of consultation is required (e.g., due to a new species listing, critical habitat designation, or new information), the Federal action agency has reinitiated the consultation and the result of the consultation is consistent with the statements above. (Note: you must include any reinitiation documentation from the Services or consulting Federal agency with your NOI.) -

- Check to confirm you have provided documentation in your SWPPP as required by CGP Appendix D.

Documentation: [Insert Text Here](#)

Eligibility Criterion

Following the process outlined in Appendix D, under which criterion are you eligible for coverage under this permit?

- Criterion F: Issuance of section 10 permit.** Potential take is authorized through the issuance of a permit under section 10 of the ESA by the USFWS and/or NMFS, and this authorization addresses the effects of the site's discharges and discharge-related activities on ESA-listed species and designated critical habitat. You must include copies of the correspondence between yourself and the participating agencies in your SWPPP and your NOI.
- Check to confirm you have provided documentation in your SWPPP as required by CGP Appendix D.

Documentation: [Insert Text Here](#)

3.2 Historic Property Screening Process

Appendix E, Step 1

Do you plan on installing any stormwater controls that require subsurface earth disturbance, including, but not limited to, any of the following stormwater controls at your site? Check all that apply below, and proceed to Appendix E, Step 2.

- Dike
- Berm
- Catch Basin
- Pond
- Constructed Site Drainage Feature (e.g., ditch, trench, perimeter drain, swale, etc.)
- Culvert
- Channel
- Other type of ground-disturbing stormwater control: [Insert Specific Type of Stormwater Control](#)

(Note: If you will not be installing any subsurface earth-disturbing stormwater controls, no further documentation is required for Section 3.2 of the Template.)

Appendix E, Step 2

If you answered yes in Step 1, have prior professional cultural resource surveys or other evaluations determined that historic properties do not exist, or have prior disturbances at the site have precluded the existence of historic properties? YES NO

- If yes, no further documentation is required for Section 3.2 of the Template and you may provide the prior documentation in your SWPPP.
 - [Insert references and information sources relied upon to determine that prior to your project, no historic properties exist at your site based on available information, including information that may be provided by your applicable SHPO, THPO, or other Tribal representative or references and information sources](#)

relied upon to determine that prior earth disturbances may have eliminated the possibility that historic properties exist on your site.

- If no, proceed to Appendix E, Step 3.

Appendix E, Step 3

If you answered no in Step 2, have you determined that your installation of subsurface earth-disturbing stormwater controls will have no effect on historic properties? YES NO

- If yes, provide documentation of the basis for your determination. [Insert references to documents, studies, or other sources relied upon](#)
- If no, proceed to Appendix E, Step 4.

Appendix E, Steps 4 and 5

If you answered no in Step 3, did the State Historic Preservation Officer (SHPO), Tribal Historic Preservation Office (THPO), or other Tribal representative (whichever applies) respond to you within 15 calendar days to indicate their views as to the likelihood that historic properties are potentially present on your site and may be impacted by the installation of stormwater controls that require subsurface earth disturbance? YES NO

- If yes, describe the nature of their response:
 - Written indication that no historic properties will be affected by the installation of stormwater controls. [Insert copies of letters, emails, or other communication between you and the applicable SHPO, THPO, or other Tribal representative](#)
 - Written indication that adverse effects to historic properties from the installation of stormwater controls can be mitigated by agreed upon actions. [Insert copies of letters, emails, or other communication between you and the applicable SHPO, THPO, or other Tribal representative](#)
 - No agreement has been reached regarding measures to mitigate effects to historic properties from the installation of stormwater controls. [Provide a description of any significant remaining disagreements regarding mitigation measures and insert copies of letters, emails, or other communication between you and the applicable SHPO, THPO, or other Tribal representative](#)
 - Other: [Insert copies of letters, emails, or other communication between you and the applicable SHPO, THPO, or other Tribal representative](#)
- If no, no further documentation is required for Section 3.2 of the Template.

3.3 Safe Drinking Water Act Underground Injection Control Requirements

Do you plan to install any of the following controls? Check all that apply below.

- Infiltration trenches (if stormwater is directed to any bored, drilled, driven shaft or dug hole that is deeper than its widest surface dimension, or has a subsurface fluid distribution system)

- Commercially manufactured pre-cast or pre-built proprietary subsurface detention vaults, chambers, or other devices designed to capture and infiltrate stormwater flow
- Drywells, seepage pits, or improved sinkholes (if stormwater is directed to any bored, drilled, driven shaft or dug hole that is deeper than its widest surface dimension, or has a subsurface fluid distribution system)

N/A.

SECTION 4: EROSION AND SEDIMENT CONTROLS AND DEWATERING PRACTICES

Erosion and sediment controls that will be implemented on site will be silt fence, rock socks, vehicle tracking control, stabilized staging areas, and concrete wash out areas. Reference City of Albuquerque Construction Site Manual (2018, current version).

4.1 Natural Buffers or Equivalent Sediment Controls

Buffer Compliance Alternatives

Are there any receiving waters within 50 feet of your project's earth disturbances? YES NO

(Note: If no, no further documentation is required for Section 4.1 in the SWPPP Template. Continue to Section 4.2.)

Check the compliance alternative that you have chosen:

- (i) I will provide and maintain a 50-foot undisturbed natural buffer.

(Note 1: You must show the 50-foot boundary line of the natural buffer on your site map.)

(Note 2: You must show on your site map how all discharges from your construction disturbances through the natural buffer area will first be treated by the site's erosion and sediment controls. Also, show on the site map any velocity dissipation devices used to prevent erosion within the natural buffer area.)

- (ii) I will provide and maintain an undisturbed natural buffer that is less than 50 feet and is supplemented by additional erosion and sediment controls that achieve, in combination, the sediment load reduction equivalent to a 50-foot undisturbed natural buffer.

(Note 1: You must show the boundary line of the natural buffer on your site map.)

(Note 2: You must show on your site map how all discharges from your construction disturbances through the natural buffer area will first be treated by the site's erosion and sediment controls. Also, show on the site map any velocity dissipation devices used to prevent erosion within the natural buffer area.)

- Insert width of natural buffer to be retained
 - Insert either of the following:
 - (1) The estimated sediment removal from a 50-foot buffer using applicable tables in Appendix F, Attachment 1. Include information about the buffer vegetation and soil type that predominate at your site
- OR
- (2) If you conducted a site-specific calculation for the estimated sediment removal of a 50-foot buffer, provide the specific removal efficiency, and information you relied upon to make your site-specific calculation
 - Insert description of additional erosion and sediment controls to be used in combination with natural buffer area
 - Insert the following information:
 - (1) Specify the model or other tool used to estimate sediment load reductions from the combination of the buffer area and additional erosion and sediment controls installed at your site, and

- (2) Include the results of calculations showing that the combination of your buffer area and the additional erosion and sediment controls installed at your site will meet or exceed the sediment removal efficiency of a 50-foot buffer

- (iii) It is infeasible to provide and maintain an undisturbed natural buffer of any size, therefore I will implement erosion and sediment controls that achieve the sediment load reduction equivalent to a 50-foot undisturbed natural buffer.
- Insert rationale for concluding that it is infeasible to provide and maintain a natural buffer of any size
 - Insert either one of the following:
 - (1) The estimated sediment removal from a 50-foot buffer using applicable tables in Appendix F, Attachment 1. Include information about the buffer vegetation and soil type that predominate at your site
- OR
- (2) If you conducted a site-specific calculation for the estimated sediment removal of a 50-foot buffer, provide the specific removal efficiency, and information you relied upon to make your site-specific calculation
 - Insert description of additional erosion and sediment controls to be used in combination with natural buffer area
 - Insert the following information:
 - (1) Specify the model or other tool used to estimate sediment load reductions from the combination of the buffer area and additional erosion and sediment controls installed at your site, and
 - (2) Include the results of calculations showing that the combination of your buffer area and the additional erosion and sediment controls installed at your site will meet or exceed the sediment removal efficiency of a 50-foot buffer

- I qualify for one of the exceptions in Part 2.2.1.b. (If you have checked this box, provide information on the applicable buffer exception that applies, below.)

Buffer Exceptions

Which of the following exceptions to the buffer requirements applies to your site?

- There is no discharge of stormwater to waters of the U.S. through the area between the disturbed portions of the site and any waters of the U.S. located within 50 feet of your site

(Note: If this exception applies, no further documentation is required for Section 4.1 of the Template.)

- No natural buffer exists due to preexisting development disturbances (e.g., structures, impervious surfaces) that occurred prior to the initiation of planning for this project.

(Note 1: If this exception applies, no further documentation is required for Section 4.1 of the Template.)

(Note 2: Where some natural buffer exists but portions of the area within 50 feet of the surface water are occupied by preexisting development disturbances, you must still comply with the one of the CGP Part 2.2.1.a compliance alternatives.)

- For “linear construction sites” (defined in Appendix A), site constraints (e.g., limited right-of-way) make it infeasible to meet any of the CGP Part 2.2.1.a compliance alternatives, provided that, to the extent feasible, you limit disturbances within 50 feet of the receiving water. [Include documentation here of the following: \(1\) why it is infeasible for you to meet one of the buffer compliance alternatives, and \(2\) buffer width retained and/or supplemental erosion and sediment controls to treat discharges to the surface water](#)

- The project qualifies as “small residential lot” construction (defined in Appendix A as “a lot being developed for residential purposes that will disturb less than 1 acre of land, but is part of a larger residential project that will ultimately disturb greater than or equal to 1 acre”) (see Appendix F, Part F.3.2).
 - For Alternative 1:
 - [Insert width of natural buffer to be retained](#)
 - [Insert applicable requirements based on Table F-1](#)
 - [Insert description of how you will comply with these requirements](#)

 - For Alternative 2:
 - [Insert \(1\) the assigned risk level based on Appendix F Applicable Table F-2 through F-6 and \(2\) the predominant soil type and average slope at your site](#)
 - [Insert applicable requirements based on Appendix F, Table F-7](#)
 - [Insert description of how you will comply with these requirements](#)

(Note 1: If you alternatively choose to comply with any of the options that are available to other sites in Part 2.2.1.a and F.2.1 of this Appendix, then additional documentation may be needed.)

- Buffer disturbances are authorized under a CWA Section 404 permit. [Insert description of any earth disturbances that will occur within the buffer area](#)

(Note 1: If this exception applies, no further documentation is required for Section 4.1 of the Template.)

(Note 2: This exception only applies to the limits of disturbance authorized under the Section 404 permit and does not apply to any disturbances within 50 feet of a receiving water that are adjacent to the disturbances authorized under Section 404 and that are covered by this permit.)

- Buffer disturbances will occur for the construction of a water-dependent structure or water access area (e.g., pier, boat ramp, and trail). [Insert description of any earth disturbances that will occur within the buffer area](#)

(Note: If this exception applies, no further documentation is required for Section 4.1 of the Template.)

4.2 **Perimeter Controls**

General

- [Silt Fence and Rock Socks shall be used in areas where on-site runoff flows off-site](#)

Specific Perimeter Controls

Silt Fence	
Description: Silt Fence (SF) is a woven geotextile fabric attached to wooden posts and trenched into the ground. It is used to intercept sheet flow runoff from disturbed areas.	
Installation	3/2/2026
Maintenance Requirements	Inspect regularly and maintain SF throughout construction. Any section of SF that has a tear, hole, slumping, undercutting or has been bypassed shall be replaced. Remove sediment before it has accumulated to one-half of the above-ground height of any perimeter control" And in CGP Part 2.2.3.cii: "After a storm event, if there is evidence of stormwater circumventing or undercutting the perimeter control, extend controls and/or repair undercut areas to fix the problem.")
Design Specifications	Reference Erosion Control Details, sheet C3.2

Rock Socks	
Description: Rock Socks (RS) is an elongated cylindrical filter constructed of gravel wrapped by wire mesh or woven geotextile (aka "curb socks" if placed at angles at curb line).	
Installation	3/2/2026
Maintenance Requirements	Inspect regularly and maintain RS as they are susceptible to displacement and breakage due to vehicle traffic. Accumulated sediment shall be removed to maintain functionality. Remove sediment before it has accumulated to one-half of the above-ground height of any perimeter control" And in CGP Part 2.2.3.cii: "After a storm event, if there is evidence of stormwater circumventing or undercutting the perimeter control, extend controls and/or repair undercut areas to fix the problem.")
Design Specifications	Reference Erosion Control Details, sheet C3.1

4.3 Sediment Track-Out

General

- Vehicle Tracking Control will be installed at all construction entrances/exits (expected along within shared access drive.)

Specific Track-Out Controls

Vehicle Tracking Control	
Description: Vehicle Tracking Control (VTC) is a stabilized site access point that helps remove sediment from vehicle tires and reduces tracking of sediment onto paved surfaces	
Installation	3/2/2026

Vehicle Tracking Control	
Maintenance Requirements	Vehicles should travel down the length of the track-out control system and not cut across the mats. Drivers should turn the wheel of their vehicles such that the vehicle will make a shallow "s-turn" route down the length of the track-out control system. The use of ice melt, rock salt, snow melt, deicer, etc. should be utilized as necessary. Where sediment has been tracked-out from your site onto paved roads, sidewalks, or other paved areas outside of your site, remove the deposited sediment by the end of the same business day in which the track-out occurs or by the end of the next business day if track-out occurs on a non-business day. Remove the track-out by sweeping, shoveling, or vacuuming these surfaces, or by using other similarly effective means of sediment removal. You are prohibited from hosing or sweeping tracked-out sediment into any constructed or natural site drainage feature, storm drain inlet, or receiving water.")
Design Specifications	Reference Erosion Control Details, sheet C3.2

4.4 Stockpiles or Land Clearing Debris Piles Comprised of Sediment or Soil

General

- Soil stockpiles shall be kept on-site in areas of undisturbed existing pavement. Stockpiles will be surrounded by a silt fence and will be stabilized if unused for 14 or more days.

Specific Stockpile Controls

Stockpile Management	
Description: Stockpile Management (SP) includes measures to minimize erosion and sediment transport from stockpiles. SP shall be used when soils or other erodible materials are stored.	
Installation	3/23/2026
Maintenance Requirements	Provide silt fence(or other comparable BMP) around the perimeter of the stockpile. Provide temporary stabilization per construction detail if stockpile is to be unused for 14 or more days. You are prohibited from hosing down or sweeping soil or sediment accumulated on pavement or other impervious surfaces into any constructed or natural site drainage feature, storm drain inlet, or receiving water")
Design Specifications	Reference Erosion Control Details, sheet C3.2

4.5 Minimize Dust

General

- Water and/or temporary seeding shall be used to keep sediment from entering the air.

Specific Dust Controls

Wind Erosion/Dust Control	
Description: Dust Control (DC) helps keep sediments (from soils and stockpiles) from entering the air as a result of land disturbing construction activities. A variety of practices that focus on grading disturbed areas may be used.	
Installation	3/2/2026

Wind Erosion/Dust Control	
Maintenance Requirements	Apply water or magnesium chloride, seed and mulch or use spray-on soil binders on disturbed areas. Water and magnesium chloride shall be applied such that concentrated flows do not form. Water shall be the primary method of dust control, with temporary seeding and/or soil binders to be used.
Design Specifications	Urban Storm Drainage Criteria Manual, Volume 3 (Mile High Flood District)

4.6 Minimize Steep Slope Disturbances

General

- Steep slopes are not anticipated with this project. If steep slopes are encountered, erosion control blankets are to be used.

Specific Steep Slope Controls

Erosion Control Blanket	
Description: A temporary degradable rolled erosion control product composed of processed natural or polymer fibers which are mechanically, structurally and/or chemically bound together to form a continuous matrix to provide erosion control and facilitate vegetation establishment.	
Installation	Not anticipated, included in this SWPPP as a precaution if steep slopes arise.
Maintenance Requirements	Check for signs of erosion, including voids beneath the mat. If voids are apparent, fill voids and replace ECB. Check for loose stakes and secure loose portions of the mat
Design Specifications	Urban Storm Drainage Criteria Manual, Volume 3 (Mile High Flood District)

4.7 Topsoil

General

- It is infeasible for this requirement to be met due to the size of the project site, the entirety of the limits of disturbance will need to be utilized for construction and installation of improvements.

Specific Topsoil Controls

N/A	
Description: N/A	
Installation	N/A
Maintenance Requirements	N/A
Design Specifications	N/A

4.8 Soil Compaction

General

- Vehicles shall be restricted to the extent practical from driving over area to be permanently landscaped. As necessary, surface roughening will be used to restore the soil.

Specific Soil Compaction Controls

Surface Roughening	
Description: Surface Roughening (SR) is tracking, scarifying, imprinting, or tilling a disturbed area to provide temporary stabilization. Variation in the soil are created to help minimize wind and water erosion.	
Installation	6/1/2026
Maintenance Requirements	Care should be taken not to drive vehicles or equipment over area that have been surface roughened. Areas should be inspected for signs of erosion. Surface roughing is a temporary measure, and will not provide long-term erosion control. Surface roughening should be done prior to final seeding and planting as necessary.
Design Specifications	Urban Storm Drainage Criteria Manual, Volume 3 (Mile High Flood District)

4.9 Storm Drain Inlets

General

- Inlet protection consisting of Rock Socks shall be used at all inlets adjacent to and immediately downstream of the project site.

Specific Storm Drain Inlet Controls

Inlet Protection	
Description: Inlet Protection (IP) is a permeable barrier that is installed around an inlet drain to filter runoff and remove sediment before entering the storm system. IP can be constructed of: RS, SCL, SF, blocks and RS, or other materials.	
Installation	3/2/2026
Maintenance Requirements	IP shall enable the drain to function without completely blocking the flow. Inspect regularly and maintain IP throughout construction as it is the final measure before runoff enters the storm drain Clean, or remove and replace, the inlet protection measures as sediment accumulates, the filter becomes clogged, and/or performance is compromised. Where there is evidence of sediment accumulation adjacent to the inlet protection measure, remove the deposited sediment by the end of the same business day in which it is found or by the end of the following business day if removal by the same business day is not feasible.")
Design Specifications	Reference Erosion Control Details, sheet C3.1

4.10 Constructed Site Drainage Feature

General

- There will be two water quality ponds constructed on site in the final condition for water quality management.

Specific Constructed Site Drainage Features

Water Quality Pond	
Description: Water Quality Ponds serve to collect surface runoff and allow for sediment to settle out of the stormwater. This project also utilizes water quality ponds that will serve at retention ponds and allow for stormwater infiltration into the soil.	
Installation	6/1/2026
Maintenance Requirements	The Water Quality Ponds shall be kept free of debris and sediment removed as necessary to provide the design volume specified.
Design Specifications	Reference Pond Grading Details, sheet DR-3

4.11 Sediment Basins or Similar Impoundments

General

- A Sediment Basin is not being utilized for this project. Due to the nature of the construction, this is not applicable, reference Section 4.10.

Specific Sediment Basin Controls

N/A	
Description: N/A	
Installation	N/A
Maintenance Requirements	N/A
Design Specifications	N/A

4.12 Chemical Treatment

Soil Types

List all the soil types including soil types expected to be exposed during construction in areas of the project that will drain to chemical treatment systems and those expected to be found in fill material: [Wink fine sandy loam](#)

Treatment Chemicals

List all treatment chemicals that will be used at the site and explain why these chemicals are suited to the soil characteristics: [No chemical treatment expected at this time](#)
 Describe the dosage of all treatment chemicals you will use at the site or the methodology you will use to determine dosage: [No chemical treatment expected at this time](#)

Provide information from any applicable Safety Data Sheets (SDS): [No chemical treatment expected at this time](#)

Describe how each of the chemicals will be stored consistent with CGP Part 2.2.13c: [No chemical treatment expected at this time](#)

Include references to applicable State or local requirements affecting the use of treatment chemicals, and copies of applicable manufacturer's specifications regarding the use of your specific treatment chemicals and/or chemical treatment systems: [No chemical treatment expected at this time](#)

Special Controls for Cationic Treatment Chemicals (if applicable)

If the applicable EPA Regional Office authorized you to use cationic treatment chemicals, include the official EPA authorization letter or other communication, and identify the specific controls and implementation procedures designed to ensure that your use of cationic treatment chemicals will not lead to a discharge that does not meet water quality standards: [No chemical treatment expected at this time](#)

Schematic Drawings of Stormwater Controls/Chemical Treatment Systems

Provide schematic drawings of any chemically-enhanced stormwater controls or chemical treatment systems to be used for application of treatment chemicals: [No chemical treatment expected at this time](#)

Training

Describe the training that personnel who handle and apply chemicals have received prior to permit coverage, or will receive prior to the use of treatment chemicals: [No chemical treatment expected at this time](#)

4.13 Dewatering Practices

General

- [At this time, dewatering is not anticipated. SWPPP to be revised if necessary.](#)

Specific Dewatering Practices

N/A	
Description: N/A	
Installation	N/A
Maintenance Requirements	For backwash water, either haul it away for disposal or return it to the beginning of the treatment process; replace and clean the filter media used in dewatering devices when the pressure differential equals or exceeds the manufacturer's specifications.
Design Specifications	N/A

[Repeat as needed for individual dewatering practices.]

4.14 Other Stormwater Controls

General

- [N/A](#)

Specific Stormwater Control Practices

N/A	
Description: N/A	
Installation	N/A
Maintenance Requirements	N/A
Design Specifications	N/A

4.15 Site Stabilization

Total Amount of Land Disturbance Occurring at Any One Time

- Five Acres or less
 More than Five Acres

Use this template box if you are not located in an arid, semi-arid, or drought-stricken area and are not discharging to a sediment- or nutrient-impaired water or Tier 2, Tier 2.5, or Tier 3 water.

Permanent Paving	
<input type="checkbox"/> Vegetative <input checked="" type="checkbox"/> Non-Vegetative <input type="checkbox"/> Temporary <input checked="" type="checkbox"/> Permanent	
Description: <ul style="list-style-type: none"> ▪ Pave portions of the completed work (both asphalt and concrete) as they are completed. ▪ Complete paving no later than 14 days after work in the area has been completed 	
Installation	6/1/2026
Completion	7/31/2026
Maintenance Requirements	Reference Construction Documents for paving specifications
Design Specifications	Reference Construction Documents for paving specifications

Landscaping	
<input checked="" type="checkbox"/> Vegetative <input type="checkbox"/> Non-Vegetative <input type="checkbox"/> Temporary <input checked="" type="checkbox"/> Permanent	
Description: <ul style="list-style-type: none"> ▪ Reference ESC Plan sheet C3.1 and Landscape Plan L1.0 for landscaping. ▪ Begin landscaping stabilization once work in the area has ceased, but no later than 14 days after work has ceased or become temporarily inactive. 	
Installation	7/1/2026
Completion	7/31/2026
Maintenance Requirements	Reference City of Albuquerque Standard Specifications Volume 1, Section 1000
Design Specifications	Reference City of Albuquerque Standard Specifications Volume 1, Section 1000

Use this template box if you are located in an arid, semi-arid, or drought-stricken area.

N/A	
<input type="checkbox"/> Vegetative <input type="checkbox"/> Non-Vegetative <input type="checkbox"/> Temporary <input type="checkbox"/> Permanent	
Description: <ul style="list-style-type: none"> ▪ ▪ 	

N/A	
Dry Period	<ul style="list-style-type: none"> ▪ Beginning month of seasonally dry period: ▪ Ending month of seasonally dry period: ▪ Site conditions during this period:
Installation and completion schedule	<ul style="list-style-type: none"> ▪ Approximate installation date: ▪ Approximate completion date:
Maintenance Requirements	
Design Specifications	

Use this template box if you are discharging to a sediment- or nutrient-impaired water or to a water that is identified by your State, Tribe, or EPA as Tier 2, Tier 2.5, or Tier 3 for antidegradation purposes.

N/A	
<input type="checkbox"/> Vegetative <input type="checkbox"/> Non-Vegetative <input type="checkbox"/> Temporary <input type="checkbox"/> Permanent	
Description:	
<ul style="list-style-type: none"> ▪ ▪ 	
Installation	
Completion	
Maintenance Requirements	
Design Specifications	

Use this template box if unforeseen circumstances have delayed the initiation and/or completion of vegetative stabilization. Note: You will not be able to include this information in your initial SWPPP. If you are affected by circumstances such as those described in CGP Part 2.2.14.b.ii, you will need to modify your SWPPP to include this information.

To be added at a later date if necessary	
<input type="checkbox"/> Vegetative <input type="checkbox"/> Non-Vegetative <input type="checkbox"/> Temporary <input type="checkbox"/> Permanent	
Description:	
<ul style="list-style-type: none"> ▪ ▪ 	
Justification	
Installation and	Vegetative Measures: <ul style="list-style-type: none"> ▪ Approximate installation date: TBD ▪ Approximate completion date: TBD

To be added at a later date if necessary	
completion schedule	Non-Vegetative Measures: <i>(Must be completed within 14 days of the cessation of construction if disturbing 5 acres or less; within 7 days if disturbing more than 5 acres)</i> <ul style="list-style-type: none">▪ Approximate installation date: TBD▪ Approximate completion date: TBD
Maintenance Requirements	
Design Specifications	

SPILL PREVENTION AND CONTROL PLAN

Whenever significant quantities of fuels, materials, vehicle fluids, or other pollutants are to be used on site, specific procedures for material containment and spill prevention shall be developed and implemented.

Introduction

The following Spill Prevention and Response Plan shall be implemented during the construction of Take 5 Oil Change and associated improvements at Lot C1 , Lovelace Heights Addition, a commercial development, and associated thereto. This plan will be implemented to meet the requirements of the City of Albuquerque (COA) and the State of New Mexico.

Materials On-Site

Spill control procedures will be implemented when materials are stockpiled or when chemicals and/or fluids are used in the construction area.

Stockpiles of Dry Materials

The following spill prevention procedures shall be implemented:

All materials shall be stockpiled in designated areas, with control measures used to reduce and minimize the runoff of contaminants. Control measures such as silt fence and sediment control logs will be installed according to COA criteria using the details shown on the SWMP plans. Loading and unloading operations shall be performed in a manner to limit materials from being spilled. Any spilled materials shall be swept up immediately after the operations are performed.

Vehicle Fueling

The following spill prevention procedures shall be implemented:

All vehicle fueling will be done off-site as much as possible. All on-site fueling operations will be performed in designated areas. Measures will be taken where necessary to reduce and minimize spills during vehicle fueling operations. These measures may include the placement of a temporary berm around the fueling area, covering the fueling area under a temporary portable structure, and/or the placement of drip pans under valves and tank openings. Berms will be constructed around all fueling areas. An adequate supply of absorbents will also be stockpiled at each fueling area.

Routine Vehicle and Equipment Maintenance

The following spill prevention procedures shall be implemented:

All vehicle maintenance will be performed off-site when possible. However, there may be occasions where construction equipment and vehicles may break down at the site and on-site repairs are more feasible. On-site vehicle and equipment maintenance, if needed, will be performed in designated areas, where practical, and enclosed by earthen berms. All maintenance areas will maintain an adequate supply of drip pans. These pans will be placed underneath vehicles as needed and absorbents will be used in the event of a minor spill or leak.

SPILL RESPONSE

NOTE: IN CASE OF FIRE, EVACUATE ALL PERSONNEL FROM THE IMMEDIATE AREA, RENDER FIRST AID TO ANYONE WHO IS INJURED, AND DIAL 911 IMMEDIATELY. TAKE APPROPRIATE STEPS TO PROTECT HUMAN LIFE AND TO CONTROL FIRES FIRST. SPILL CONTROL IS A SECONDARY CONCERN.

Cleanup and Removal Procedures

- Upon detection of any spill, the first action to be taken is to ensure personal safety. All possible ignition sources, including running engines, electrical equipment (including cellular telephones, etc.), or other hazards will be immediately turned off or removed from the area. The extent of the spill and the nature of the spilled material will be evaluated to determine if remedial actions could result in any health hazards, escalation of the spill, or further damage that would intensify the problem. If such conditions exist, a designated employee will oversee the area of the spill and the construction supervisor will be notified immediately.
- The source of the spill will be identified and if possible the flow of pollutants stopped if it can be done safely. However, no employee will attend to the source or begin cleanup of the spill until ALL emergency priorities (fire, injuries, etc.) have been addressed.

Small Spills

Small spills (usually <5 gallons) consist of minor quantities of gasoline, oil, anti-freeze, or other materials that can be cleaned up by a single employee using readily available materials.

The following procedures shall be used for clean up of small spills:

1. Ensure personal safety, evaluate the spill, and if possible, stop the flow of pollutants.
2. Contain the spread of the spill using absorbents, portable berms, sandbags, or other available measures.
3. Spread absorbent materials on the area to soak up as much of the liquid as possible and to prevent or minimize infiltration into the soil.
4. Once the liquids have been absorbed, remove all absorbents from the spill and place the materials in a suitable storage container. On paved areas, wipe any remaining liquids from the surface and place the materials in a storage container. Do not spray or wash down the area using water. For open soil areas, excavate any contaminated soil as soon as possible and place the soil in a suitable storage container. All materials will then be transported off-site for disposal.
5. If immediate transfer and storage of the contaminated soil is not practical, excavate and place the contaminated soil on a double thickness sheet of 3-mil or higher polyethylene film. In addition, a small berm should be formed around the outer edges of the soil stockpile, underneath the polyethylene film, to ensure that contaminants are not washed from the site during precipitation events and that materials do not seep through the berm.
6. Record all significant facts and information about the spill, including the following:
 - Type of pollutant
 - Location
 - Apparent source
 - Estimated volume
 - Time of discovery
 - Actions taken to clean up spill

7. Notify the supervisor of the spill and provide the information from Item #6. The supervisor will then contact the City of Albuquerque and Bernalillo County.

Medium to Large Spills

Medium to large spills consist of larger quantities of materials (usually >5 - 25 gallons) that are used on site that cannot be controlled by a single employee. Generally, a number of facility personnel will be needed to control the spill and a response may require the suspension of other facility activities.

The following procedure shall be used for the cleanup of medium to large spills:

1. Ensure personal safety, evaluate the spill, and if possible, stop the flow of pollutants.
2. Immediately dispatch a front-end loader or similar equipment to the spill and construct a berm or berms down gradient of the spill to minimize the spread of potential pollutants. On paved surfaces, portable berms, sandbags, booms, or other measures will be used to control the lateral spread of the pollutants.
3. When the spread of the spill has been laterally contained, contact the supervisor or designated facility employee and provide them information on the location, type, and amount of spilled material, and a briefing on the extent of the spread and measures undertaken to contain the contaminants.
4. Depending on the nature of the spill, mobilize additional resources as needed to contain the contaminants.
5. Cleanup will commence when the lateral spread has been contained and the notification to the supervisor has been made.
6. Freestanding liquid will be bailed or pumped into 55-gallon storage drums, steel tanks, or other suitable storage containers. When all the liquid has been removed from the pavement or soil layer, absorbents will be applied to the surface and transferred to the storage containers when they have soaked up as much of the spill as possible.
7. On paved surfaces, the remaining contaminants will be removed to the extent possible, with rags, sweeping, or similar measures. The area of the spill will not be sprayed or washed down using water. Any contaminant soaked materials will be placed into the storage containers with the other absorbents.
8. The remaining contaminated soils will be excavated and loaded into a dump truck(s) for disposal off-site at a designated facility. If transport off-site is not immediately available, the remaining soils will be stockpiled on a double thickness sheet of 3-mil or higher polyethylene film. In addition, a small berm will be formed around the outer edges of the soil stockpile, underneath the polyethylene film, to ensure that contaminants are not washed from the site during precipitation and do not seep through the berm.
9. Record all significant facts and information about the spill, including the following:
 - Type of pollutant
 - Location
 - Apparent source
 - Estimated volume
 - Time of discovery
 - Actions taken to clean up spill
10. Provide the supervisor (or designated employee) with the information from Item #9. The supervisor will then contact the City of Albuquerque and Bernalillo County.

NOTIFICATION

Notification to the New Mexico Environment Department (NMED) and City of Albuquerque is required if there is any release or suspected release of any substance, including oil or other substances that spill into or threaten State waters. Unless otherwise noted, notifications are to be made by the supervisor and only after emergency responses related to the release have been implemented. This will prevent misinformation and assures that notifications are properly conducted.

The notification requirements are as follows:

1. Spills into/or Threatens State Waters: Immediate notification is required for releases that occur beneath the surface of the land or impact or threaten waters of the State of threaten the public health and welfare. Notifications that will be made are:
 - a. For any substance, regardless of quantity, contact NMED. State as follows:
 - a) Give you name.
 - b) Give location of spill (name of city).
 - c) Describe the nature of the spill, type of products, and estimate size of spill.
 - d) Describe type of action taken thus far, type of assistance or equipment needed.
 - b. For any quantity of oil or other fluids, call the National Response Center at 1-800-424-8802. State as follows:
 - a) Give your name.
 - b) Give location of spill (name of city and state).
 - c) Describe the nature of the spill, type of product, and estimate size of spill.
 - d) Describe type of action taken thus far, type of assistance or equipment needed.
2. Reportable Quantity Spill on Land Surface: Immediate notification is required of a release upon the land surface of an oil in quantity that exceeds 25 gallons, or of a hazardous substance that equals or exceeds 10 pounds or its reportable quantity under Section 101(14) of the Comprehensive Environmental Response, Compensation Liability Act (CERCLA) of 1980 as amended (40 CFR Part 302) and Section 329c(F3)of the Emergency Planning and Community Right to Know Act of 1986 (40 CFR Part 355) whichever is less. This requirement does apply at a minimum to the substances listed in Table A below.

TABLE A
Substances Requiring Notification

SUBSTANCE	REPORTABLE QUANTITY
Motor Oil	25 Gallons
Hydraulic Oil	25 Gallons
Gasoline/Diesel Fuel	25 Gallons

- The notification procedures to be followed are:
- a) Give your name.
 - b) Give location of spill (name of city and state).
 - c) Describe nature of the spill, type of product, and estimate size of spill.
 - d) Describe type of action taken thus far, type of assistance or equipment needed.
 - e) Give name of land owner
 - f) Specify department responsible for any facilities that may be impacted
3. Notification is not required for release of oil upon the land surface of 25 gallons or less - that will not constitute a threat to public health and welfare, the environmental or a threat of entering the waters of the State.
 4. Notification, as required in paragraphs 1 and 2 above, will be made to the NMED using the 24-hour telephone number to report environmental spills. All information known about the

release at the time of discovery is to be included, such as the time of occurrence, quantity and type of material, location and any corrective or clean-up actions presently being taken. Table B lists these phone numbers.

SPILL RESPONSE CONTACTS

TABLE B

Emergency Notification Contacts

Name/Agency	Number
Albuquerque Fire Department	911
Albuquerque Police Department	911
Ambulance	911
Hospital	911
National Response Center	1-800-424-8802
NMED - Report Environmental Spills (24 hrs/day)	505-827-9329
Bernalillo County Sheriff's Office	505-468-7100
City of Albuquerque	505-768-2000

It is the responsibility of the supervisor to contact the City of Albuquerque, Bernalillo County, NMED, and/or the National Response Center.

- The **National Response Center** is to be contacted when a release containing a hazardous substance or oil in an amount equal to or in excess of a reportable quantity established under either 40 CFR 110, 4- DFR 117, or 40CFR 302 occurs during a 24-hour period.
- Notification to the NMED is required if there is any release or suspected release of any material, including oil or hazardous substances that spill into or threaten state waters.

REPORTS

The NMED requires written notification of a spill or discharge of oil or other substance that may cause pollution of the waters of the State of New Mexico. A written report must be submitted to the Water Quality Control District (WQCD) within five days after becoming aware of the spill or discharge.

The NMED requires a written final report within five days for all releases of an oil or hazardous substance that require implementation of a contingency plan. The NMED may also require additional reports on the status of the clean up until any required remedial action has been complete.

Written notification of reports must contain at a minimum:

1. Date, time, and duration of the release.
2. Location of the release.
3. Person or persons causing and responsible for the release.
4. Type and amount of oil or substance released.
5. Cause of the release.
6. Environmental damage caused by the release.
7. Actions taken to respond, contain, and clean up the release.
8. Location and method of ultimate disposal of the oil or other fluids.
9. Actions taken to prevent a reoccurrence of the release.
10. Any known or anticipated acute or chronic health risks associated with the release.
11. When appropriate advice regarding medical attention necessary for exposed individuals.

Site Spill Log

Site Location: _____

General Contractor: _____

Any site spill must be reported to the appropriate authorities in accordance with all applicable laws and regulations. Spills must also be reported to the owner's representative immediately, but no later than 24 hours of occurrence.

Date / Time of Spill: _____

Name / Title: _____

Material Spilled and Approximate Quantity: _____

Weather Conditions: _____

Phase of Construction: _____ (Clearing, Rough Grading, Building, Paving, Etc.)

Contractor(s) Representatives Present:

Containment Actions Taken and Authorities Notified:

Date / Time of Spill: _____

Name / Title: _____

Material Spilled and Approximate Quantity:

Weather Conditions: _____

Phase of Construction: _____ (Clearing, Rough Grading, Building, Paving, Etc.)

Contractor(s) Representatives Present:

Containment Actions Taken and Authorities Notified:

SECTION 5: POLLUTION PREVENTION CONTROLS

5.1 Potential Sources of Pollution

Construction Site Pollutants

Pollutant-Generating Activity	Pollutants or Pollutant Constituents (That could be discharged if exposed to stormwater)	Location on Site (Or reference SWPPP site map where this is shown)
Disturbed and Stored Soil	Sediment	Stockpile (central to site, see ESC Plans)
Vehicle Tracking of Sediments	Sediment	Proposed site access along shared access drive.
Outdoor Storage Areas	Paint, fuel, oil, form oil, hydraulic fluid, plumbing glue, fertilizer	Stabilized Storage Area (Central to site, see SSA on ESC Plans)
Fueling/Maintenance of Vehicles/Equipment	Fuel, oil, hydraulic fluid, detergents, solvents	Stabilized Storage Area (Central to site, see SSA on ESC Plans)
Concrete Truck/Equipment Washing	Concrete, sediment	Concrete Washout Area (CWA adjacent to VTC)
Solid Waste Storage and Disposal	Trash/Debris, portable toilet	Stabilized Storage Area (Central to site, see SSA on ESC Plans); Portable Toilet (PT)

5.2 Spill Prevention and Response

5.3 Fueling and Maintenance of Equipment or Vehicles

General

- Vehicle/Equipment fueling and maintenance will only be performed within the stabilized staging area. A Spill Control and Containment Kit will be accessible at the stabilized storage area.

Specific Pollution Prevention Practices

Spill Control and Containment Kit	
Description: A spill control and containment kit (containing for example, absorbent material such as kitty litter or sawdust, acid neutralizing agent, brooms, dust pans, mops, rags, gloves, goggles, plastic and metal trash containers, etc. will be provided onsite.	
Implementation	3/2/2026
Maintenance Requirements	The Kit shall be inspected for completeness weekly, and any materials used shall be replaced as soon as practically possible once used.
Design Specifications	Reference best practices for proper spill kit items and procedures.

5.4 Washing of Equipment and Vehicles

General

- Vehicle/Equipment washing to occur adjacent to the Concrete Washout Area to contain and limit washing runoff. Soaps and Solvents to be covered by plastic sheeting when not in use.

Specific Pollution Prevention Practices

Concrete Washout Area	
Description: CWA is a specific area for concrete washing and other washing activities. It can be an excavation of a pit in the ground, above ground storage area or prefabricated haul-away container.	
Implementation	3/2/2026
Maintenance Requirements	Inspect regularly and maintain CWA throughout construction. Ensure adequate signage is in place identifying the location of the CWA. Remove waste when filled to about 2/3 of CWA capacity to maintain functionality.
Design Specifications	Reference Erosion Control Details, sheet C3.2

5.5 Storage, Handling, and Disposal of Building Products, Materials, and Wastes

5.5.1 Building Materials and Building Products

(Note: Examples include asphalt sealants, copper flashing, roofing materials, adhesives, concrete admixtures, and gravel and mulch stockpiles.)

General

- Building materials and products shall be covered to minimize exposure to precipitation and stormwater runoff.

Specific Pollution Prevention Practices

Plastic Sheeting	
Description: Cover materials	
Implementation	3/23/2026
Maintenance Requirements	Regularly inspect plastic sheeting for damage and inspect materials for evidence of water runoff. Replace plastic sheeting as necessary to prevent leaking and exposure.
Design Specifications	N/A

5.5.2 Pesticides, Herbicides, Insecticides, Fertilizers, and Landscape Materials

General

- Chemicals shall be covered to minimize exposure to precipitation and stormwater runoff. Comply with all manufacturer instructions and spill prevention documentation.

Specific Pollution Prevention Practices

Plastic Sheeting	
Description: Cover materials	
Implementation	Implementation
Maintenance Requirements	Maintenance Requirements
Design Specifications	Design Specifications

5.5.3 Diesel Fuel, Oil, Hydraulic Fluids, Other Petroleum Products, and Other Chemicals

General

- Ensure containers are water-tight and sealed unless actively being used. Store chemicals at least 50' from sidewalk culverts, water quality ponds, and store in a spill containment pallet. Maintain Spill Kit per previous instructions.

Specific Pollution Prevention Practices

Insert name of pollution prevention practice	
Description: Reference Section 5.3	
Implementation	3/2/2026
Maintenance Requirements	
Design Specifications	

5.5.4 Hazardous or Toxic Waste

(Note: Examples include paints, caulks, sealants, fluorescent light ballasts, solvents, petroleum-based products, wood preservatives, additives, curing compounds, and acids.)

General

- Ensure hazardous waste will be separate from non-hazardous waste and labeled per RCRA specifications in sealed containers. Store under plastic sheeting adjacent to Spill Control and Containment Kit. Clean up spills immediately, following manufacturer's specifications.

Specific Pollution Prevention Practices

Spill Control and Containment Kit	
Description: Reference section 5.3	
Implementation	3/2/2026
Maintenance Requirements	
Design Specifications	

5.5.5 Construction and Domestic Waste

(Note: Examples include packaging materials, scrap construction materials, masonry products, timber, pipe and electrical cuttings, plastics, styrofoam, concrete, demolition debris, and other trash or discarded materials.)

General

- Provide dumpster withing stabilized storage area. Do not leave waste onsite outside of waste disposal area, and empty dumpster prior to dumpster overflowing. Cover dumpster with plastic sheeting prior to rainfall events.

Specific Pollution Prevention Practices

Dumpster	
Description: Provide dumpster within stabilized storage area for construction and domestic waste	
Implementation	3/2/2026
Maintenance Requirements	Empty dumpster prior to waste overflowing. Inspect regularly for waste spillage. Cover with plastic sheeting prior to rainfall events.
Design Specifications	N/A

5.5.6 Sanitary Waste

General

- Provide portable toilets within stabilized storage area

Specific Pollution Prevention Practices

Portable Toilet	
Description: Provide portable toilets onsite within stabilized storage area	
Implementation	3/2/2026
Maintenance Requirements	Secure portable toilet so that it will not be tipped over. Inspect regularly for leaks.
Design Specifications	N/A

5.6 Washing of Applicators and Containers used for Stucco, Paint, Concrete, Form Release Oils, Cutting Compounds, or Other Materials

General

- Provide concrete washout area adjacent to VTC along the south of the site

Specific Pollution Prevention Practices

Concrete Washout Area	
Description: Reference Section 5.4	
Implementation	3/2/2026
Maintenance Requirements	
Design Specifications	

5.7 Application of Fertilizers

General

- Apply fertilizers per manufacturer instructions and at an appropriate time of year. Avoid applying before forecasted rainfall events and do not apply to constructed drainage features.

Specific Pollution Prevention Practices

N/A	
Description:	
Implementation	Click or tap to enter a date.
Maintenance Requirements	
Design Specifications	

5.8 Other Pollution Prevention Practices

General

- N/A

Specific Pollution Prevention Practices

N/A	
Description:	
Implementation	Click or tap to enter a date.
Maintenance Requirements	
Design Specifications	

SECTION 6: INSPECTION, MAINTENANCE, AND CORRECTIVE ACTION

6.1 Inspection Personnel and Procedures

Site Inspection Schedule

Select the inspection frequency(ies) that applies, based on CGP Parts 4.2, 4.3, or 4.4

(Note: you may be subject to different inspection frequencies in different areas of the site. Check all that apply and indicate which portion(s) of the site it applies to.)

Standard Frequency:
<input checked="" type="checkbox"/> Every 7 calendar days
<input type="checkbox"/> Every 14 calendar days and within 24 hours of either: <ul style="list-style-type: none">▪ A storm event that produces 0.25 inches or more of rain within a 24-hour period (including when there are multiple, smaller storms that alone produce less than 0.25 inches but together produce 0.25 inches or more in 24 hours), or▪ A storm event that produces 0.25 inches or more of rain within a 24-hour period on the first day of a storm and continues to produce 0.25 inches or more of rain on subsequent days (you conduct an inspection within 24 hours of the first day of the storm and within 24 hours after the last day of the storm that produces 0.25 inches or more of rain (i.e., only two inspections would be required for such a storm event)), or▪ A discharge caused by snowmelt from a storm event that produces 3.25 inches or more of snow within a 24-hour period.
Increased Frequency (if applicable):
For areas of sites discharging to sediment or nutrient-impaired waters or to waters designated as Tier 2, Tier 2.5, or Tier 3
<input type="checkbox"/> Every 7 days and within 24 hours of either: <ul style="list-style-type: none">▪ A storm event that produces 0.25 inches or more of rain within a 24-hour period, or▪ A discharge caused by snowmelt from a storm event that produces 3.25 inches or more of snow within a 24-hour period.
Reduced Frequency (if applicable)
For stabilized areas
<input checked="" type="checkbox"/> Twice during first month, no more than 14 calendar days apart; then once per month after first month until permit coverage is terminated consistent with Part 9 in any area of your site where the stabilization steps in 2.2.14.a have been completed. <ul style="list-style-type: none">▪ To be specified at a later date if portions of construction are stabilized▪ TBD <p>(Note: It is likely that you will not be able to include this in your initial SWPPP. If you qualify for this reduction (see CGP Part 4.4.1), you will need to modify your SWPPP to include this information. If construction activity resumes in this portion of the site at a later date, the inspection frequency immediately increases to that required in Parts 4.2 and 4.3, as applicable.)</p>

For stabilized areas on “linear construction sites” (as defined in Appendix A)

- Twice during first month, no more than 14 calendar days apart; then once more within 24 hours of a storm event that produces 0.25 inches or more of rain within a 24-hour period, or within 24 hours of a snowmelt discharge from a storm event that produces 3.25 inches or more of snow within a 24-hour period
 - Specify locations where stabilization steps have been completed
 - Insert date that they were completed(Note: It is likely that you will not be able to include this in your initial SWPPP. If you qualify for this reduction (see CGP Part 4.4.1), you will need to modify your SWPPP to include this information.)

For arid, semi-arid, or drought-stricken areas during seasonally dry periods or during drought

- Once per month and within 24 hours of either:
 - A storm event that produces 0.25 inches or more of rain within a 24-hour period, or
 - A snowmelt discharge from a storm event that produces 3.25 inches or more of snow within a 24-hour period.

Insert beginning and ending month identified as the seasonally dry period for your area or the valid period of drought:

- Beginning month of the seasonally dry period: [Insert approximate date](#)
- Ending month of the seasonally dry period: [Insert approximate date](#)

For frozen conditions where construction activities are being conducted

- Once per month

Insert beginning and ending dates of frozen conditions on your site:

- Beginning date of frozen conditions: [Insert approximate date](#)
- Ending date of frozen conditions: [Insert approximate date](#)

For frozen conditions where construction activities are suspended

- Inspections are temporarily suspended

Insert beginning and ending dates of frozen conditions on your site:

- Beginning date of frozen conditions: [Insert approximate date](#)
- Ending date of frozen conditions: [Insert approximate date](#)

Dewatering Inspection Schedule

Select the inspection frequency that applies based on CGP Part 4.3.2

Dewatering Inspection

- Once per day on which the discharge of dewatering water occurs.

Rain Gauge Location (if applicable)

N/A

Inspection Report Forms

[Reference Appendix D](#)

(Note: EPA has developed a sample inspection form that CGP operators can use. The form is available at <https://www.epa.gov/npdes/stormwater-discharges-construction-activities#resources>)

6.2 Corrective Action

Personnel Responsible for Corrective Actions

Ethan Shultz, Tyrel Parker

Corrective Action Logs

Reference Appendix E

(Note: EPA has developed a sample corrective action log that CGP operators can use. The form is available at <https://www.epa.gov/npdes/stormwater-discharges-construction-activities#resources>)

6.3 Delegation of Authority

Duly Authorized Representative(s) or Position(s):

N/A

SECTION 7: TURBIDITY BENCHMARK MONITORING FOR DEWATERING DISCHARGES

Procedures:

Collecting and evaluating samples	This section is not required, dewatering is not anticipated
Reporting results and keeping monitoring information records	
Taking corrective action when necessary	

Turbidity Meter:

Type of turbidity meter	
-------------------------	--

Turbidity meter manuals and manufacturer instructions

N/A

Coordinating Arrangements for Turbidity Monitoring (if applicable):

Permitted operator name	N/A
Permitted operator NPDES ID	
Coordinating Arrangement	

Alternate turbidity benchmark (if applicable):

Alternate turbidity benchmark (NTU)	N/A
Data and documentation used to request the alternate benchmark	

SECTION 8: CERTIFICATION AND NOTIFICATION

I certify under penalty of law that this document and all attachments were prepared under my direction or supervision in accordance with a system designed to assure that qualified personnel properly gathered and evaluated the information submitted. Based on my inquiry of the person or persons who manage the system, or those persons directly responsible for gathering the information, the information submitted is, to the best of my knowledge and belief, true, accurate, and complete. I have no personal knowledge that the information submitted is other than true, accurate, and complete. I am aware that there are significant penalties for submitting false information, including the possibility of fine and imprisonment for knowing violations.

Name: _____ Title: _____

Signature: _____ Date: _____

SWPPP APPENDICES

Attach the following documentation to the SWPPP:

Appendix A – Site Maps

Appendix B – Copy of 2022 CGP

(Note: The 2022 CGP is available at <https://www.epa.gov/npdes/2022-construction-general-permit-cgp>)

Appendix C – NOI and EPA Authorization Email

Appendix D – Site Inspection Form and Dewatering Inspection Form (if applicable)

(Note: EPA has developed a sample site inspection form template that CGP operators can use. The template is available at <https://www.epa.gov/npdes/construction-general-permit-resources-tools-and-templates>). Where the operator will be dewatering at the site, EPA has developed a separate dewatering inspection form template to use to document the required information. This template is available at <https://www.epa.gov/npdes/construction-general-permit-resources-tools-and-templates>.

Appendix E – Corrective Action Log

(Note: EPA has developed a sample corrective action log that CGP operators can use. The form is available at <https://www.epa.gov/npdes/construction-general-permit-resources-tools-and-templates>)

Appendix F – SWPPP Amendment Log

Appendix G – Subcontractor Certifications/Agreements

Appendix H – Grading and Stabilization Activities Log

Appendix I – Training Documentation

Appendix J – Delegation of Authority

Appendix K – Endangered Species Documentation

Appendix L – Historic Preservation Documentation

Appendix M – Rainfall Gauge Recording

Appendix N – Turbidity Meter Manual and Manufacturer's Instructions

Appendix A – Site Maps

DURBAN DEVELOPMENT TAKE 5 OIL CHANGE

LOCATED ON THE S.W. CORNER OF GIBSON BLVD AND YALE BLVD
CITY OF ALBUQUERQUE, BERNALILLO COUNTY, NEW MEXICO
2030 GIBSON BOULEVARD
CIVIL CONSTRUCTION DRAWINGS

OWNER/DEVELOPER

DURBAN DEVELOPMENT
106 FOSTER AVENUE
CHARLOTTE, NC, 28203
EMAIL: zach.holland@durbandevelopment.com
ATTN: ZACK HOLLAND, ASST DIR.

CIVIL ENGINEER

GALLOWAY & COMPANY, INC.
5500 GREENWOOD PLAZA BLVD., SUITE 200
GREENWOOD VILLAGE, COLORADO 80111
TEL: (303) 770-8884
ATTN: TROY KELTS, P.E.

LANDSCAPE ARCHITECT

GALLOWAY & COMPANY, INC.
5500 GREENWOOD PLAZA BLVD., SUITE 200
GREENWOOD VILLAGE, COLORADO 80111
TEL: (303) 770-8884
ATTN: TROY NOSER, RLA

SURVEYOR

SURV-TEK, INC.
P.O. BOX 66885
ALBUQUERQUE, NM 87114
TEL: (505) 300-4732
ATTN: RUSS P. HUGG, P.S.

GEOTECHNICAL ENGINEER

WESTERN TECHNOLOGIES, INC.
8305 WASHINGTON PLACE
ALBUQUERQUE, NM 87113
TEL: (602) 437-3737
ATTN: JUSTIN M. HEINECKE, P.E.

AGENCIES

PLANNING

CITY OF ALBUQUERQUE PLANNING DEPARTMENT
PLAZA DEL SOL BUILDING
600 SECOND NW
ALBUQUERQUE, NM 87102
TEL: (505) 924-3860
EMAIL: PLANNINGDEPARTMENT@CABQ.GOV

WATER & SANITARY

ALBUQUERQUE BERNALILLO COUNTY WATER UTILITY AUTHORITY
1441 MISSION AVE. NE
ALBUQUERQUE, NM 87113
TEL: 505-842-WATR

STORM SEWER

DEPARTMENT OF MUNICIPAL DEVELOPMENT
ONE CIVIC PLAZA
ROOM 7057
ALBUQUERQUE, NEW MEXICO 87102
TEL: (505) 768-3830

RIGHT-OF-WAY ACTIVITIES

CONSTRUCTION SERVICES DIVISION
600 SECOND STREET NW, ROOM 800
ALBUQUERQUE NM, 87102
TEL: (505) 924-3400

ELECTRIC

PNM
414 SILVER AVENUE SW
ALBUQUERQUE, NM 87102
TEL: (505) 241-2700

FIRE PROTECTION

ALBUQUERQUE FIRE RESCUE
11500 SUNSET GARDENS SW
ALBUQUERQUE, NM 87121
TEL: (505) 244-3473

GAS

NEW MEXICO GAS COMPANY
4625 EDITH BOULEVARD
ALBUQUERQUE, NM 87107
TEL: (888) 664-2726

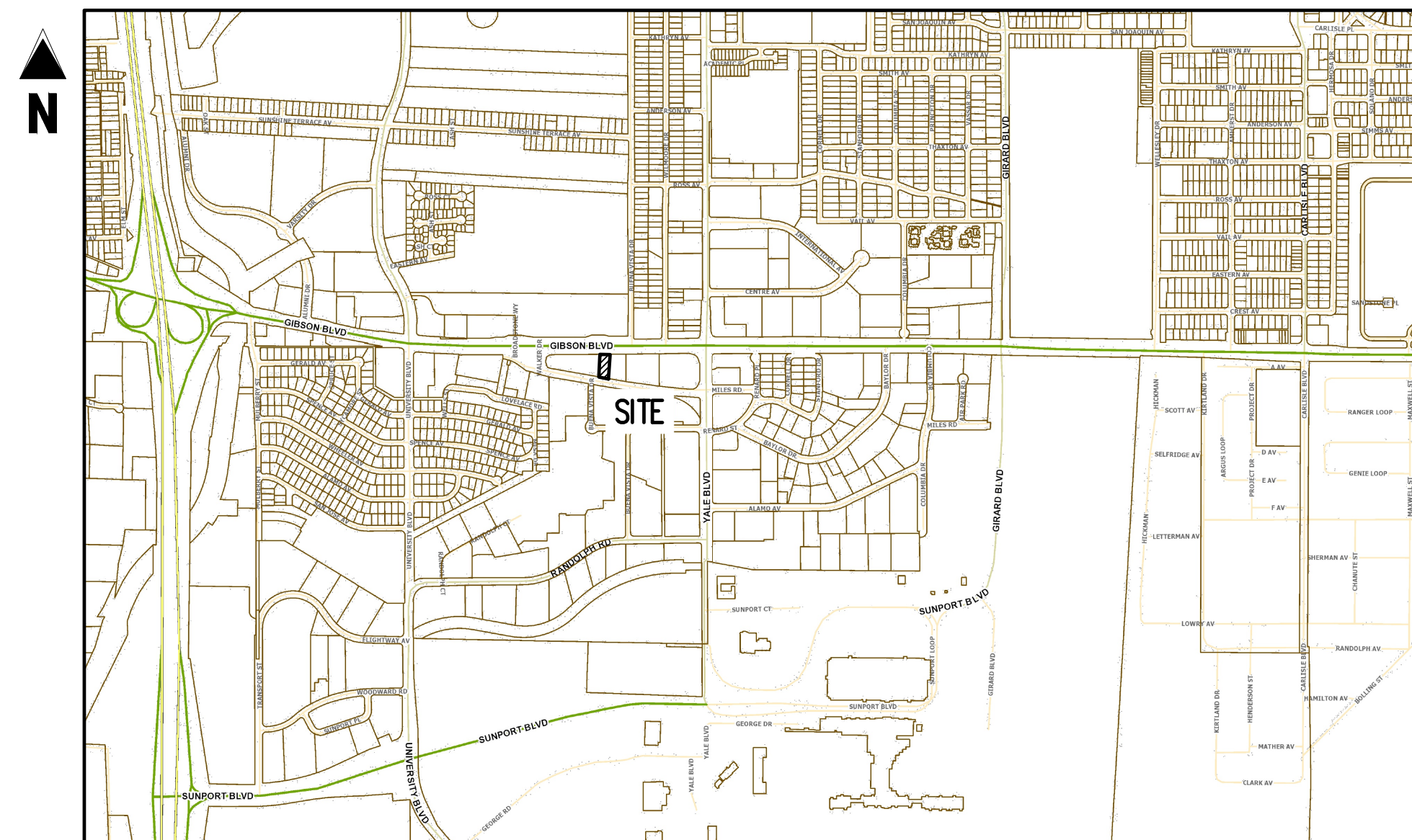

ZONE MAP: M-15 AND L-15
NOT TO SCALE

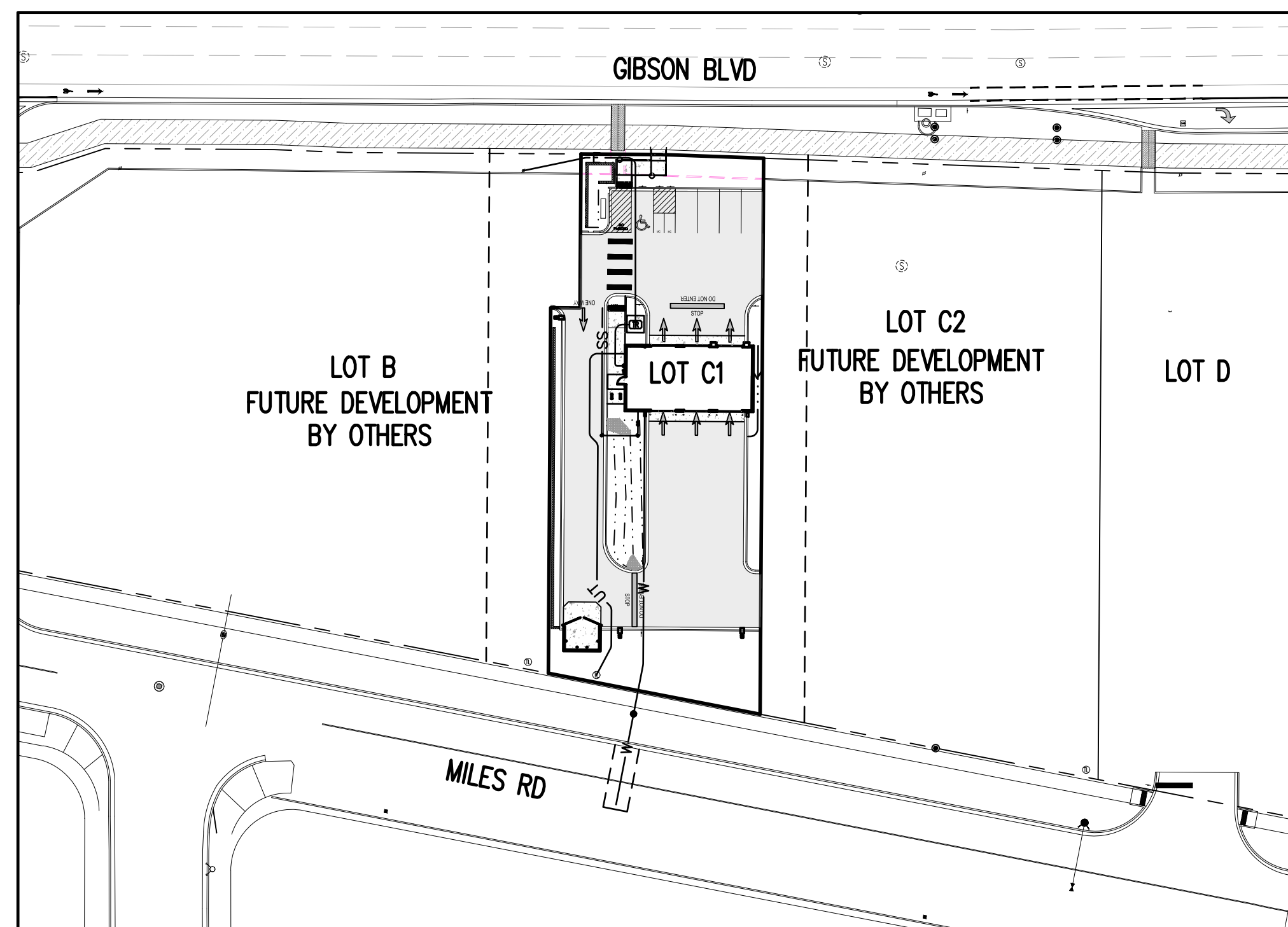

PROJECT MAP
SCALE: 1"=150'

Sheet List Table	
SHEET NUMBER	SHEET TITLE
C3.0	ESC COVER SHEET
C3.1	EROSION CONTROL PLAN
C3.2	EROSION CONTROL DETAILS
C3.3	EROSION CONTROL DETAILS

STORMWATER MANAGEMENT PLANS GENERAL NOTES

- THE CONTRACTOR AND/OR AUTHORIZED AGENTS SHALL REMOVE ALL SEDIMENT, MUD, CONSTRUCTION DEBRIS, OR OTHER POTENTIAL POLLUTANTS THAT MAY HAVE BEEN DISCHARGED TO OR ACCUMULATE IN THE FLOW LINES AND PUBLIC RIGHTS OF WAYS OF THE CITY AS A RESULT OF CONSTRUCTION ACTIVITIES ASSOCIATED WITH THIS SITE DEVELOPMENT OR CONSTRUCTION PROJECT. SAID REMOVAL SHALL BE CONDUCTED IN A TIMELY MANNER.
- ADDITIONAL EROSION AND SEDIMENT CONTROL MEASURES MAY BE REQUIRED OF THE OWNER AND HIS OR HER AGENTS DUE TO UNFORESEEN EROSION PROBLEMS OR IF THE SUBMITTED PLAN DOES NOT FUNCTION AS INTENDED. THE REQUIREMENTS OF THIS PLAN SHALL BE THE OBLIGATION OF THE PERMIT HOLDER UNTIL SUCH TIME AS THE PLAN IS PROPERLY COMPLETED AND THE PERMIT IS RELEASED.
- THE CONTRACTOR SHALL PREVENT SEDIMENT, DEBRIS AND ALL OTHER POLLUTANTS FROM ENTERING THE STORM SEWER SYSTEM DURING ALL DEMOLITION, EXCAVATION, TRENCHING, BORING, GRADING OR OTHER CONSTRUCTION OPERATIONS THAT ARE PART OF THIS PROJECT. THE CONTRACTOR SHALL BE HELD RESPONSIBLE FOR REMEDIATION OF ANY ADVERSE IMPACTS TO ADJACENT WATERWAYS, WETLANDS, ETC., RESULTING FROM WORK DONE AS PART OF THIS PROJECT.
- THE CONTRACTOR SHALL LOCATE, INSTALL, AND MAINTAIN ALL EROSION CONTROL AND WATER QUALITY "BEST MANAGEMENT PRACTICES" AS INDICATED IN THE APPROVED STORMWATER MANAGEMENT PLAN.
- THE DEVELOPER, GENERAL CONTRACTOR, GRADING CONTRACTOR AND/OR THEIR AUTHORIZED AGENTS SHALL INSURE THAT ALL LOADS OF CUT AND FILL MATERIAL IMPORTED TO OR EXPORTED FROM THIS SITE SHALL BE PROPERLY COVERED TO PREVENT LOSS OF THE MATERIAL DURING TRANSPORT ON PUBLIC RIGHTS OF WAY.
- SOILS THAT WILL BE STOCKPILED FOR MORE THAN 30 DAYS SHALL BE PROTECTED FROM WIND AND WATER EROSION WITHIN 14 DAYS OF STOCKPILE CONSTRUCTION. IF STOCKPILES ARE LOCATED WITHIN 100 FEET OF A DRAINAGEWAY, ADDITIONAL SEDIMENT CONTROLS SUCH AS TEMPORARY DIKES OR SILT FENCE SHALL BE REQUIRED.
- APPROVED EROSION AND SEDIMENT CONTROL BEST MANAGEMENT PRACTICES SHALL BE MAINTAINED AND KEPT IN GOOD REPAIR OF THE DURATION OF THIS PROJECT. ACCUMULATED SEDIMENT AND DEBRIS SHALL BE REMOVED FROM A BMP WHEN THE SEDIMENT OR DEBRIS ADVERSELY IMPACTS THE FUNCTIONING OF THE BMP.

BASIS OF BEARING

BEARINGS ARE NEW MEXICO STATE PLANE GRID BEARINGS, CENTRAL ZONE - NAD 83.

LEGAL DESCRIPTION

PROPOSED LOT LETTERED "C-1" OF THE REPLAT OF LOT LETTERED "C" OF LOVELACE HEIGHTS ADDITION, (BEING A REPLAT OF TRACTS A-1A, B-1, AND C-1, LOVELACE HEIGHTS ADDITION), WITHIN SECTION 33, TOWNSHIP 10 NORTH, RANGE 3 EAST, NEW MEXICO PRINCIPAL MERIDIAN, CITY OF ALBUQUERQUE, BERNALILLO COUNTY, NEW MEXICO, AS THE SAME IS SHOWN AND DESIGNATED ON THE PLAT THEREOF, FILED IN THE OFFICE OF THE COUNTY CLERK OF BERNALILLO COUNTY, NEW MEXICO ON JUNE 10, 2022 IN PLAT BOOK 2022C, PAGE 57

SOIL PREPARATION AND PAVEMENT DESIGN NOTE

SOIL PREPARATION AND PAVEMENT DESIGN SHALL BE PER RECOMMENDATIONS FROM A GEOTECHNICAL REPORT PREPARED FOR THIS SITE AS FOLLOWS:

GEOTECHNICAL ENGINEER: WESTERN TECHNOLOGIES, INC.
PROJECT NO: 3220J031 DATE: MAY 9, 2021

THE CONTRACTOR MUST FULLY REVIEW THIS REPORT PRIOR TO CONSTRUCTION. INFORMATION IN THE GEOTECHNICAL REPORT SUPERSEDES ANY CONFLICTING INFORMATION CONTAINED IN THE CONSTRUCTION PLANS AND SPECIFICATIONS. REFER TO GENERAL STRUCTURAL NOTES FOR SPECIFIC SOIL PREPARATION AT SITE STRUCTURES.

CONTRACTOR RESPONSIBLE FOR AS-BUILT DRAWINGS, TESTS, REPORTS AND/OR ANY OTHER CERTIFICATES OR INFORMATION AS REQUIRED FOR ACCEPTANCE OF WORK FROM CITY, UTILITY DISTRICTS OR ANY OTHER GOVERNING AGENCY.

NOTE: CONTRACTOR MUST COORDINATE WORK WITH UTILITY COMPANY AND CITY PRIOR TO BEGINNING WORK AND IS RESPONSIBLE FOR ALL MATERIALS, LABOR, REPAIRS, ETC. TO COMPLETE WORK AND RESTORE AREA TO SAME STATE PRIOR TO STARTING WORK

NOTE: CONTRACTOR SHALL PROTECT ALL EXISTING SURVEY MONUMENTATION. CONTRACTOR SHALL HAVE LICENSED SURVEYOR REPLACE ANY DAMAGED OR DISTURBED MONUMENTATION AT THEIR COST.

SURVEYOR TO OBTAIN AUTOCAD FILE FROM ENGINEER AND VERIFY ALL HORIZONTAL CONTROL DIMENSIONING PRIOR TO CONSTRUCTION STAKING. SURVEYOR MUST VERIFY ALL BENCHMARK, BASIS OF BEARING AND DATUM INFORMATION TO ENSURE IMPROVEMENTS WILL BE AT THE SAME HORIZONTAL AND VERTICAL LOCATIONS SHOWN ON THE DESIGN CONSTRUCTION DRAWINGS. PRIOR TO CONSTRUCTION STAKING ANY DISCREPANCY MUST BE REPORTED TO OWNER AND ENGINEER PRIOR TO CONTINUATION OF ANY FURTHER STAKING OR CONSTRUCTION WORK.

NO.	DATE	DESCRIPTION	BY
1	09/19/2023	1ST TCL SUBMITTAL	TDK
2	08/15/2025	2ND TCL SUBMITTAL	TDK
3	09/03/2025	3RD TCL SUBMITTAL	TDK

	ENGINEER STAMP & SIGNATURE	APPROVALS	ENGINEER	DATE	*****
		DRC CHAIRPERSON			APPROVED FOR CONSTRUCTION
		TRANSPORTATION			ESC COVER SHEET
		WATER/WASTEWATER			
		HYDROLOGY			
	PARKS				
	CONST. MGMT.				CITY ENGINEER DATE
	CONST. COORD.				
	CITY PROJECT NO.				SHEET
					C3.0
					PAGE 1 OF 4



CALL NM ONE-CALL
SYSTEM SEVEN (7) DAYS
PRIOR TO ANY EXCAVATION

Galloway

5500 Greenwood Plaza Blvd., Suite 200
Greenwood Village, CO 80111
303.770.8884
GallowayUS.com

Silt Fence (SF)

SC-1

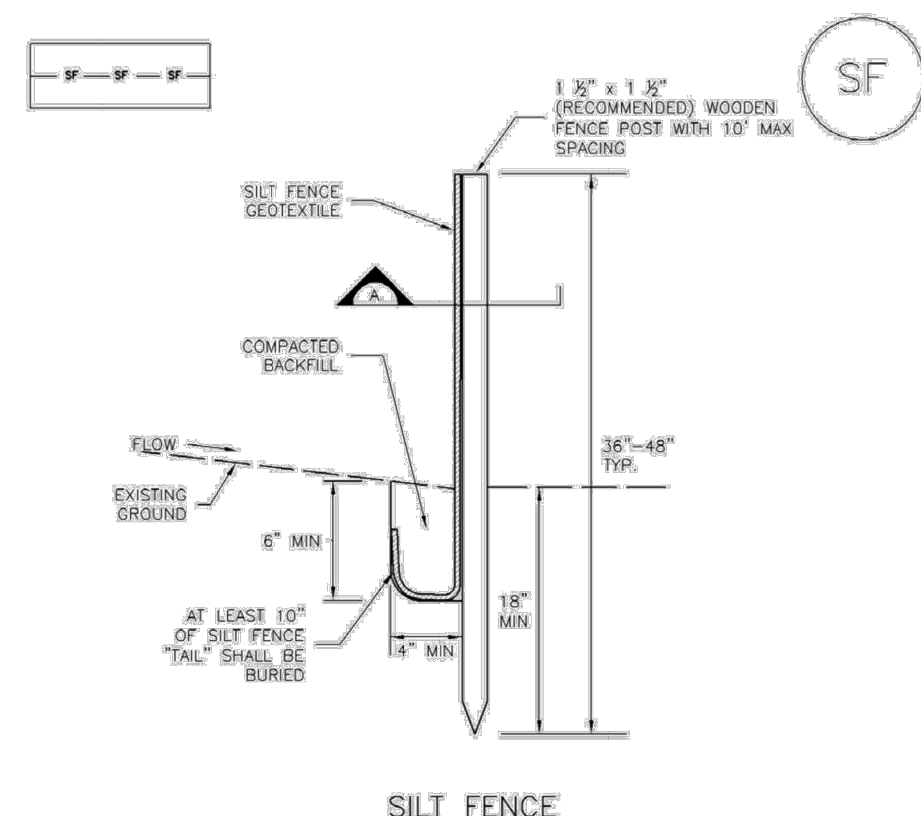

SILT FENCE

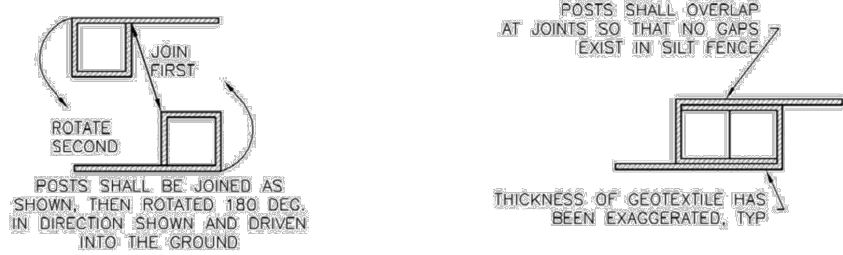

SECTION A

SF-1. SILT FENCE

November 2010 Urban Drainage and Flood Control District Urban Storm Drainage Criteria Manual Volume 3 SF-3

SC-1

Silt Fence (SF)

SILT FENCE INSTALLATION NOTES

1. SILT FENCE MUST BE PLACED AWAY FROM THE TOE OF THE SLOPE TO ALLOW FOR WATER PONDING. SILT FENCE AT THE TOE OF A SLOPE SHOULD BE INSTALLED IN A FLAT LOCATION AT LEAST SEVERAL FEET (2-5 FT) FROM THE TOE OF THE SLOPE TO ALLOW ROOM FOR PONDING AND DEPOSITION.
2. A UNIFORM 6\"/>

SILT FENCE MAINTENANCE NOTES

1. INSPECT BMPs EACH WORKDAY, AND MAINTAIN THEM IN EFFECTIVE OPERATING CONDITION. MAINTENANCE OF BMPs SHOULD BE PROACTIVE, NOT REACTIVE. INSPECT BMPs AS SOON AS POSSIBLE (AND ALWAYS WITHIN 24 HOURS) FOLLOWING A STORM THAT CAUSES SURFACE EROSION, AND PERFORM NECESSARY MAINTENANCE.
2. FREQUENT OBSERVATIONS AND MAINTENANCE ARE NECESSARY TO MAINTAIN BMPs IN EFFECTIVE OPERATING CONDITION. INSPECTIONS AND CORRECTIVE MEASURES SHOULD BE DOCUMENTED THOROUGHLY.
3. WHERE BMPs HAVE FAILED, REPAIR OR REPLACEMENT SHOULD BE INITIATED UPON DISCOVERY OF THE FAILURE.
4. SEDIMENT ACCUMULATED UPSTREAM OF THE SILT FENCE SHALL BE REMOVED AS NEEDED TO MAINTAIN THE FUNCTIONALITY OF THE BMP, TYPICALLY WHEN DEPTH OF ACCUMULATED SEDIMENTS IS APPROXIMATELY 6\"/>

(LOCAL ADAPTED FROM TOWN OF PARKER, COLORADO AND CITY OF ALBUQUERQUE, NEW MEXICO)
NOTE: MANY JURISDICTIONS HAVE BMP DETAILS THAT VARY FROM UDFCD STANDARD DETAILS. CONSULT WITH LOCAL JURISDICTIONS AS TO WHICH DETAIL SHOULD BE USED WHEN DIFFERENCES ARE NOTED.

SF-4 Urban Drainage and Flood Control District Urban Storm Drainage Criteria Manual Volume 3 November 2010

SC-5

Rock Sock (RS)

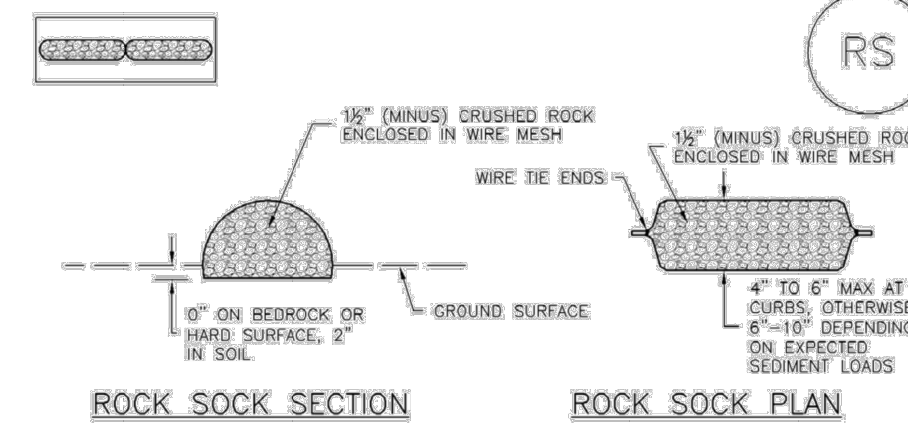

ROCK SOCK SECTION

ROCK SOCK PLAN

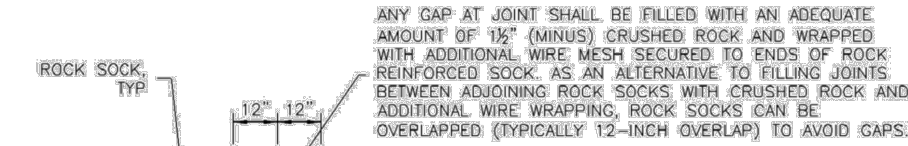

ROCK SOCK JOINTING

ROCK SOCK INSTALLATION NOTES

1. SEE PLAN VIEW FOR: -LOCATION(S) OF ROCK SOCKS.
2. CRUSHED ROCK SHALL BE 1/2\"/>

RS-1. ROCK SOCK PERIMETER CONTROL

RS-2 Urban Drainage and Flood Control District Urban Storm Drainage Criteria Manual Volume 3 November 2010

Rock Sock (RS)

SC-5

ROCK SOCK MAINTENANCE NOTES

1. INSPECT BMPs EACH WORKDAY, AND MAINTAIN THEM IN EFFECTIVE OPERATING CONDITION. MAINTENANCE OF BMPs SHOULD BE PROACTIVE, NOT REACTIVE. INSPECT BMPs AS SOON AS POSSIBLE (AND ALWAYS WITHIN 24 HOURS) FOLLOWING A STORM THAT CAUSES SURFACE EROSION, AND PERFORM NECESSARY MAINTENANCE.
2. FREQUENT OBSERVATIONS AND MAINTENANCE ARE NECESSARY TO MAINTAIN BMPs IN EFFECTIVE OPERATING CONDITION. INSPECTIONS AND CORRECTIVE MEASURES SHOULD BE DOCUMENTED THOROUGHLY.
3. WHERE BMPs HAVE FAILED, REPAIR OR REPLACEMENT SHOULD BE INITIATED UPON DISCOVERY OF THE FAILURE.
4. ROCK SOCKS SHALL BE REPLACED IF THEY BECOME HEAVILY SOILED, OR DAMAGED BEYOND REPAIR.
5. SEDIMENT ACCUMULATED UPSTREAM OF ROCK SOCKS SHALL BE REMOVED AS NEEDED TO MAINTAIN FUNCTIONALITY OF THE BMP, TYPICALLY WHEN DEPTH OF ACCUMULATED SEDIMENTS IS APPROXIMATELY 6\"/>

(LOCAL ADAPTED FROM TOWN OF PARKER, COLORADO AND CITY OF ALBUQUERQUE, NEW MEXICO)
NOTE: MANY JURISDICTIONS HAVE BMP DETAILS THAT VARY FROM UDFCD STANDARD DETAILS. CONSULT WITH LOCAL JURISDICTIONS AS TO WHICH DETAIL SHOULD BE USED WHEN DIFFERENCES ARE NOTED.

NOTE: THE DETAILS INCLUDED WITH THIS FACT SHEET SHOW COMMONLY USED, CONVENTIONAL METHODS OF ROCK SOCK INSTALLATION IN THE DENVER METROPOLITAN AREA. THERE ARE MANY OTHER SIMILAR PROPRIETARY PRODUCTS ON THE MARKET. UDFCD NEITHER ENDORSES NOR DISCOURAGES USE OF PROPRIETARY PROTECTION PRODUCTS; HOWEVER, IN THE EVENT PROPRIETARY METHODS ARE USED, THE APPROPRIATE DETAIL FROM THE MANUFACTURER MUST BE INCLUDED IN THE SWMP AND THE BMP MUST BE INSTALLED AND MAINTAINED AS SHOWN IN THE MANUFACTURER'S DETAILS.

November 2010 Urban Drainage and Flood Control District Urban Storm Drainage Criteria Manual Volume 3 RS-3

SILT FENCE

ROCK SOCKS

Concrete Washout Area (CWA)

MM-1

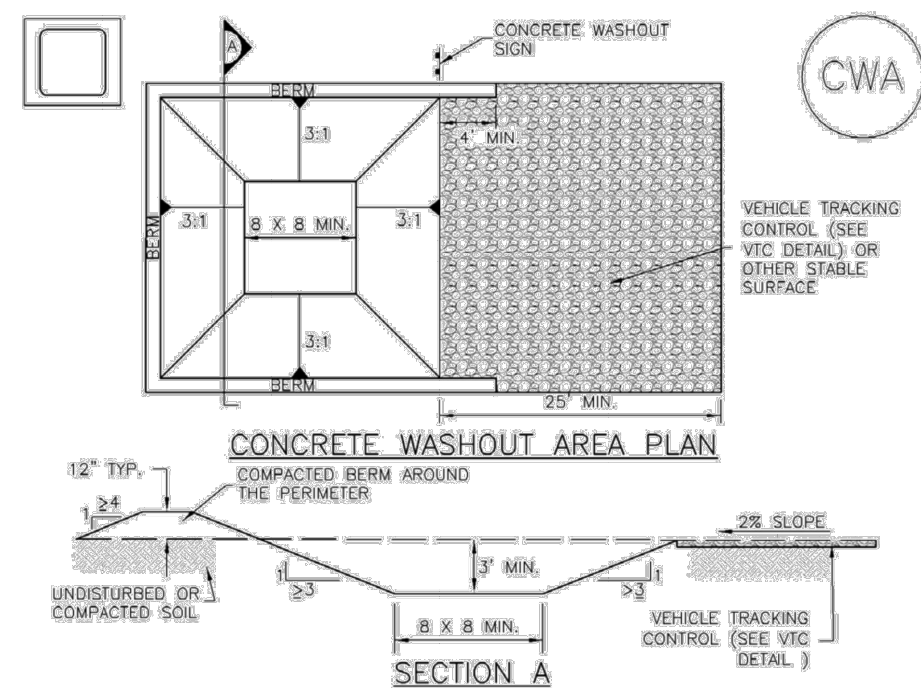

CONCRETE WASHOUT AREA PLAN

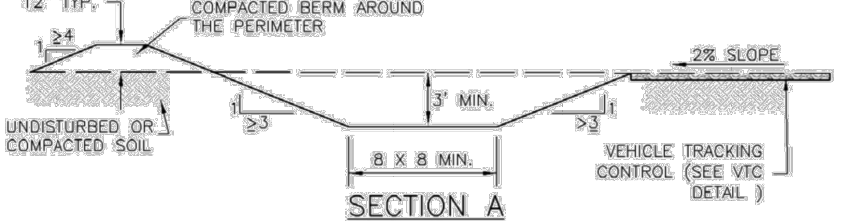

SECTION A

CWA-1. CONCRETE WASHOUT AREA

- CWA INSTALLATION NOTES**
1. SEE PLAN VIEW FOR: -CWA INSTALLATION LOCATION.
 2. DO NOT LOCATE AN UNGRAINED CWA WITHIN 400' OF ANY NATURAL DRAINAGE PATHWAY OR WATERBODY, DO NOT LOCATE WITHIN 1,000' OF ANY WELLS OR DRINKING WATER SOURCES. IF SITE CONSTRAINTS MAKE THIS IMPRACTICABLE, OR IF HIGHLY PERMEABLE SOILS EXIST ON SITE, THE CWA MUST BE INSTALLED WITH AN IMPERMEABLE LINER (1.5 MIL MIN. THICKNESS) OR SURFACE STORAGE ALTERNATIVES USING PREFABRICATED CONCRETE WASHOUT DEVICES OR A LINED ABOVE GROUND STORAGE ARE SHOULD BE USED.
 3. THE CWA SHALL BE INSTALLED PRIOR TO CONCRETE PLACEMENT ON SITE.
 4. CWA SHALL INCLUDE A FLAT SUBSURFACE PIT THAT IS AT LEAST 8\"/>

November 2010 Urban Drainage and Flood Control District Urban Storm Drainage Criteria Manual Volume 3 CWA-3

MM-1

Concrete Washout Area (CWA)

CWA MAINTENANCE NOTES

1. INSPECT BMPs EACH WORKDAY, AND MAINTAIN THEM IN EFFECTIVE OPERATING CONDITION. MAINTENANCE OF BMPs SHOULD BE PROACTIVE, NOT REACTIVE. INSPECT BMPs AS SOON AS POSSIBLE (AND ALWAYS WITHIN 24 HOURS) FOLLOWING A STORM THAT CAUSES SURFACE EROSION, AND PERFORM NECESSARY MAINTENANCE.
2. FREQUENT OBSERVATIONS AND MAINTENANCE ARE NECESSARY TO MAINTAIN BMPs IN EFFECTIVE OPERATING CONDITION. INSPECTIONS AND CORRECTIVE MEASURES SHOULD BE DOCUMENTED THOROUGHLY.
3. WHERE BMPs HAVE FAILED, REPAIR OR REPLACEMENT SHOULD BE INITIATED UPON DISCOVERY OF THE FAILURE.
4. THE CWA SHALL BE REPAIRED, CLEANED, OR ENLARGED AS NECESSARY TO MAINTAIN CAPACITY FOR CONCRETE WASTE. CONCRETE MATERIALS, ACCUMULATED IN PIT, SHALL BE REMOVED ONCE THE MATERIALS HAVE REACHED A DEPTH OF 2\"/>

(LOCAL ADAPTED FROM BOULDER COUNTY, COLORADO AND THE CITY OF PARKER, COLORADO, NOT AVAILABLE IN AUTOCAD)
NOTE: MANY JURISDICTIONS HAVE BMP DETAILS THAT VARY FROM UDFCD STANDARD DETAILS. CONSULT WITH LOCAL JURISDICTIONS AS TO WHICH DETAIL SHOULD BE USED WHEN DIFFERENCES ARE NOTED.

CWA-4 Urban Drainage and Flood Control District Urban Storm Drainage Criteria Manual Volume 3 November 2010

STORMWATER MANAGEMENT PLANS GENERAL NOTES

1. DETAILS PROVIDED ON THIS SHEET ARE SUPERCEDED BY THE CITY OF ALBUQUERQUE CONSTRUCTION SITE MANUAL (2018, CURRENT EDITION). THE CONSTRUCTION SITE MANUAL GOVERNS IF ANY CONFLICTS ARISE.
2. THE CONTRACTOR AND/OR AUTHORIZED AGENTS SHALL REMOVE ALL SEDIMENT, MUD, CONSTRUCTION DEBRIS, OR OTHER POTENTIAL POLLUTANTS THAT MAY HAVE BEEN DISCHARGED TO OR, ACCUMULATE IN, THE FLOW LINES AND PUBLIC RIGHTS OF WAYS OF THE CITY AS A RESULT OF CONSTRUCTION ACTIVITIES ASSOCIATED WITH THIS SITE DEVELOPMENT OR CONSTRUCTION PROJECT. SAID REMOVAL SHALL BE CONDUCTED IN A TIMELY MANNER.
3. ADDITIONAL EROSION AND SEDIMENT CONTROL MEASURES MAY BE REQUIRED OF THE OWNER AND HIS OR HER AGENTS DUE TO UNFORESEEN EROSION PROBLEMS OR IF THE SUBMITTED PLAN DOES NOT PERFORM AS INTENDED. THE REQUIREMENTS OF THIS PLAN SHALL BE THE OBLIGATION OF THE PERMIT HOLDER UNTIL SUCH TIME AS THE PLAN IS PROPERLY COMPLETED AND THE PERMIT IS RELEASED.
4. THE CONTRACTOR SHALL PREVENT SEDIMENT, DEBRIS AND ALL OTHER POLLUTANTS FROM ENTERING THE STORM SEWER SYSTEM DURING ALL DEMOLITION, EXCAVATION, TRENCHING, BORING, GRADING OR OTHER CONSTRUCTION OPERATIONS THAT ARE PART OF THIS PROJECT. THE CONTRACTOR SHALL BE HELD RESPONSIBLE FOR REMEDIATION OF ANY ADVERSE IMPACTS TO ADJACENT WATERWAYS, WETLANDS, ETC., RESULTING FROM WORK DONE AS PART OF THIS PROJECT.
5. THE CONTRACTOR SHALL LOCATE, INSTALL, AND MAINTAIN ALL EROSION CONTROL AND WATER QUALITY BEST MANAGEMENT PRACTICES AS INDICATED IN THE APPROVED STORMWATER MANAGEMENT PLAN.
6. THE DEVELOPER, GENERAL CONTRACTOR, GRADING CONTRACTOR AND/OR THEIR AUTHORIZED AGENTS SHALL INSURE THAT ALL LOADS OF CUT AND FILL MATERIAL IMPORTED TO OR EXPORTED FROM THIS SITE SHALL BE PROPERLY COVERED TO PREVENT LOSS OF THE MATERIAL DURING TRANSPORT ON PUBLIC RIGHTS OF WAY.
7. SOILS THAT WILL BE STOCKPILED FOR MORE THAN 30 DAYS SHALL BE PROTECTED FROM WIND AND WATER EROSION WITHIN 14 DAYS OF STOCKPILE CONSTRUCTION. IF STOCKPILES ARE LOCATED WITHIN 100 FEET OF A DRAINAGEWAY, ADDITIONAL SEDIMENT CONTROLS SUCH AS TEMPORARY DIKES OR SILT FENCE SHALL BE REQUIRED.
8. APPROVED EROSION AND SEDIMENT CONTROL BEST MANAGEMENT PRACTICES SHALL BE MAINTAINED AND KEPT IN GOOD REPAIR OF THE DURATION OF THIS PROJECT. ACCUMULATED SEDIMENT AND DEBRIS SHALL BE REMOVED FROM A BMP WHEN THE SEDIMENT OR DEBRIS ADVERSELY IMPACTS THE FUNCTIONING OF THE BMP.

BMP MAINTENANCE NOTE:
ALL EROSION AND SEDIMENT CONTROL PRACTICES AND OTHER PROTECTIVE MEASURES IDENTIFIED IN THE SWMP MUST BE MAINTAINED IN EFFECTIVE OPERATING CONDITION. PROPER SELECTION AND INSTALLATION OF BMPs AND IMPLEMENTATION OF COMPREHENSIVE INSPECTION AND MAINTENANCE PROCEDURES IN ACCORDANCE WITH THE SWMP, SHOULD BE ADEQUATE TO MEET THIS CONDITION. BMPs THAT ARE NOT ADEQUATELY MAINTAINED IN ACCORDANCE WITH GOOD ENGINEERING, HYDROLOGIC AND POLLUTION CONTROL PRACTICES, INCLUDING REMOVAL OF COLLECTED SEDIMENT OUTSIDE THE ACCEPTABLE TOLERANCES OF THE BMPs, ARE CONSIDERED TO BE NO LONGER OPERATING EFFECTIVELY AND MUST BE ADDRESSED.



CALL NM ONE-CALL SYSTEM SEVEN (7) DAYS PRIOR TO ANY EXCAVATION

CONCRETE WASHOUT AREA

DESIGN REVIEW COMMITTEE	CITY ENGINEER APPROVAL	ZONE MAP NO. M-15 & L-15
		CITY PROJECT NO.
		SHEET NO. C3.2
		PAGE 3 OF 4

Galloway
5500 Greenbush Plaza Blvd., Suite 200
Colorado Springs, CO 80911
303.770.8884
GallowayUS.com

CONSULTANTS

TROY D. KELTS
NEW MEXICO
22102
1/14/2026
PROFESSIONAL ENGINEER

VERTICAL DATUM IS BASED UPON ALBUQUERQUE CONTROL SURVEY MONUMENT "ACS BM 24-L16".
ELEVATION = 5191.31 FEET (NAVD 88)

SEAL

1ST TOL SUBMITTAL	DATE	BY
2ND TOL SUBMITTAL		
3RD TOL SUBMITTAL		
DESCRIPTION	CONTRACTOR:	
AS-BUILT INFORMATION	WORK STAKED BY:	
INSPECTOR'S ACCEPTANCE BY:	DATE:	
FIELD VERIFICATION BY:	DATE:	
DRAWINGS CORRECTED BY:	DATE:	

DESIGNED BY: DDJ
DRAWN BY: HCH
CHECKED BY: TDK
DATE: 09/03/2025

LOVELACE HEIGHTS ADDITION
CITY OF ALBUQUERQUE
2030 GIBSON BOULEVARD

**EROSION CONTROL
DETAILS**

Stockpile Management (SP)

MM-2

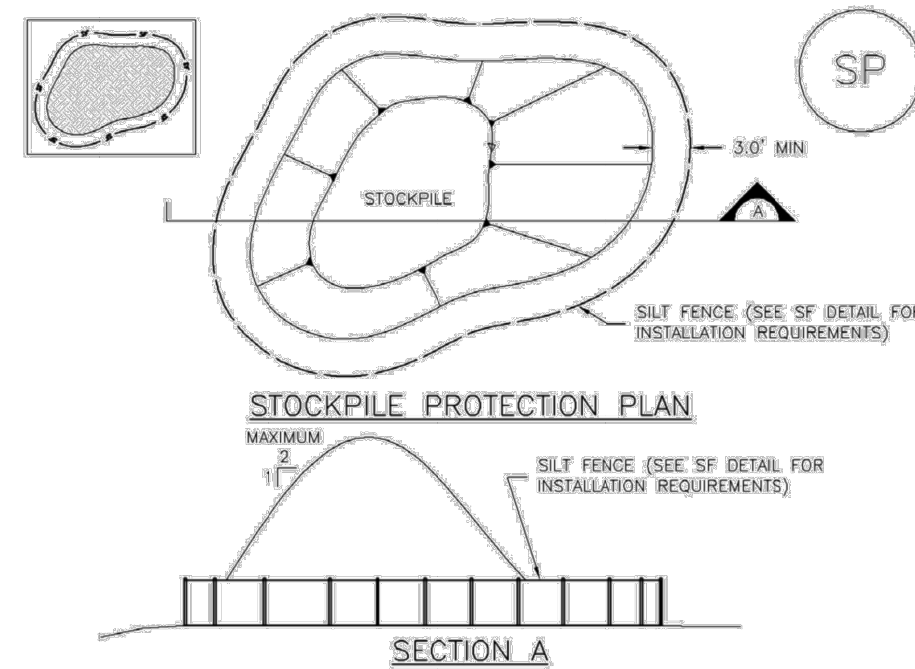

SP-1. STOCKPILE PROTECTION

STOCKPILE PROTECTION INSTALLATION NOTES

- SEE PLAN VIEW FOR:
 - LOCATION OF STOCKPILES
 - TYPE OF STOCKPILE PROTECTION.
- INSTALL PERIMETER CONTROLS IN ACCORDANCE WITH THEIR RESPECTIVE DESIGN DETAILS. SILT FENCE IS SHOWN IN THE STOCKPILE PROTECTION DETAILS; HOWEVER, OTHER TYPES OF PERIMETER CONTROLS INCLUDING SEGMENT CONTROL LOGS OR STOCKS MAY BE SUITABLE IN SOME CIRCUMSTANCES. CONSIDERATIONS FOR DETERMINING THE APPROPRIATE TYPE OF PERIMETER CONTROL FOR A STOCKPILE INCLUDE: WHETHER THE STOCKPILE IS LOCATED ON A PERVIOUS OR IMPERVIOUS SURFACE, THE RELATIVE HEIGHTS OF THE PERIMETER CONTROL AND STOCKPILE, THE ABILITY OF THE PERIMETER CONTROL TO CONTAIN THE STOCKPILE WITHOUT FAILING IN THE EVENT THAT MATERIAL FROM THE STOCKPILE SHIFTS OR SLUMPS AGAINST THE PERIMETER, AND OTHER FACTORS.
- STABILIZE THE STOCKPILE SURFACE WITH SURFACE ROUGHENING, TEMPORARY SEEDING AND MULCHING, EROSION CONTROL BLANKETS, OR SOIL BINDERS. SOIL STOCKPILES FOR AN EXTENDED PERIOD (TYPICALLY FOR MORE THAN 60 DAYS) SHOULD BE SEEDED AND MULCHED WITH A TEMPORARY GRASS COVER ONCE THE STOCKPILE IS PLACED (TYPICALLY WITHIN 14 DAYS). USE OF MULCH ONLY OR A SOIL BINDER IS ACCEPTABLE IF THE STOCKPILE WILL BE IN PLACE FOR A MORE LIMITED TIME PERIOD (TYPICALLY 30-60 DAYS).
- FOR TEMPORARY STOCKPILES ON THE INTERIOR PORTION OF A CONSTRUCTION SITE, WHERE OTHER DOWNSTREAM CONTROLS, INCLUDING PERIMETER CONTROLS, ARE IN PLACE, STOCKPILE PERIMETER CONTROLS MAY NOT BE REQUIRED.

November 2010 Urban Drainage and Flood Control District
Urban Storm Drainage Criteria Manual Volume 3 SP-3

SP STOCKPILE

MM-2

Stockpile Management (SM)

STOCKPILE PROTECTION MAINTENANCE NOTES

- INSPECT BMPs EACH WORKDAY, AND MAINTAIN THEM IN EFFECTIVE OPERATING CONDITION. MAINTENANCE OF BMPs SHOULD BE PROACTIVE; NOT REACTIVE. INSPECT BMPs AS SOON AS POSSIBLE (AND ALWAYS WITHIN 24 HOURS) FOLLOWING A STORM THAT CAUSES SURFACE EROSION, AND PERFORM NECESSARY MAINTENANCE.
- FREQUENT OBSERVATIONS AND MAINTENANCE ARE NECESSARY TO MAINTAIN BMPs IN EFFECTIVE OPERATING CONDITION. INSPECTIONS AND CORRECTIVE MEASURES SHOULD BE DOCUMENTED THOROUGHLY.
- WHERE BMPs HAVE FAILED, REPAIR OR REPLACEMENT SHOULD BE INITIATED UPON DISCOVERY OF THE FAILURE.

STOCKPILE PROTECTION MAINTENANCE NOTES

- IF PERIMETER PROTECTION MUST BE MOVED TO ACCESS SOIL STOCKPILE, REPLACE PERIMETER CONTROLS BY THE END OF THE WORKDAY.
- STOCKPILE PERIMETER CONTROLS CAN BE REMOVED ONCE ALL THE MATERIAL FROM THE STOCKPILE HAS BEEN USED.

(DETAILS ADAPTED FROM PARKER, COLORADO, NOT AVAILABLE IN AUTOCAD)

NOTE: MANY JURISDICTIONS HAVE BMP DETAILS THAT VARY FROM IUDFC STANDARD DETAILS. CONSULT WITH LOCAL JURISDICTIONS AS TO WHICH DETAIL SHOULD BE USED WHEN DIFFERENCES ARE NOTED.

SP-4 Urban Drainage and Flood Control District
Urban Storm Drainage Criteria Manual Volume 3 November 2010

Stabilized Staging Area (SSA)

SM-6

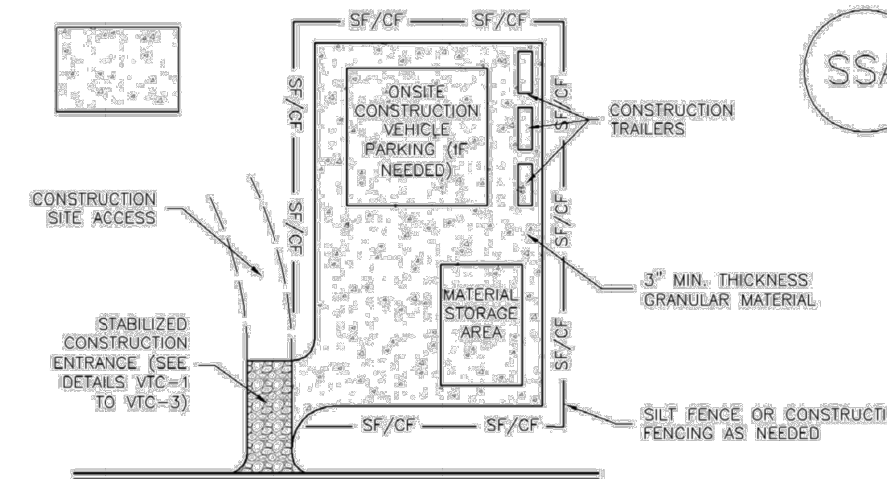

SSA-1. STABILIZED STAGING AREA

STABILIZED STAGING AREA INSTALLATION NOTES

- SEE PLAN VIEW FOR:
 - LOCATION OF STAGING AREA(S)
 - CONTRACTOR MAY ADJUST LOCATION AND SIZE OF STAGING AREA WITH APPROVAL FROM THE LOCAL JURISDICTION.
- STABILIZED STAGING AREA SHOULD BE APPROPRIATE FOR THE NEEDS OF THE SITE. OVERSIZING RESULTS IN A LARGER AREA TO STABILIZE FOLLOWING CONSTRUCTION.
- STAGING AREA SHALL BE STABILIZED PRIOR TO OTHER OPERATIONS ON THE SITE.
- THE STABILIZED STAGING AREA SHALL CONSIST OF A MINIMUM 3" THICK GRANULAR MATERIAL.
- UNLESS OTHERWISE SPECIFIED BY LOCAL JURISDICTION, ROCK SHALL CONSIST OF DOT SECT. #703, AASHTO #3 COARSE AGGREGATE OR 8" (MINUS) ROCK.
- ADDITIONAL PERIMETER BMPs MAY BE REQUIRED INCLUDING BUT NOT LIMITED TO SILT FENCE AND CONSTRUCTION FENCING.

STABILIZED STAGING AREA MAINTENANCE NOTES

- INSPECT BMPs EACH WORKDAY, AND MAINTAIN THEM IN EFFECTIVE OPERATING CONDITION. MAINTENANCE OF BMPs SHOULD BE PROACTIVE; NOT REACTIVE. INSPECT BMPs AS SOON AS POSSIBLE (AND ALWAYS WITHIN 24 HOURS) FOLLOWING A STORM THAT CAUSES SURFACE EROSION, AND PERFORM NECESSARY MAINTENANCE.
- FREQUENT OBSERVATIONS AND MAINTENANCE ARE NECESSARY TO MAINTAIN BMPs IN EFFECTIVE OPERATING CONDITION. INSPECTIONS AND CORRECTIVE MEASURES SHOULD BE DOCUMENTED THOROUGHLY.
- WHERE BMPs HAVE FAILED, REPAIR OR REPLACEMENT SHOULD BE INITIATED UPON DISCOVERY OF THE FAILURE.
- ROCK SHALL BE REPLACED OR REGRADE AS NECESSARY IF ROUTING OCCURS OR UNDERLYING SUBGRADE BECOMES EXPOSED.

November 2010 Urban Drainage and Flood Control District
Urban Storm Drainage Criteria Manual Volume 3 SSA-3

SSA STABILIZED STAGING AREA

SM-6

Stabilized Staging Area (SSA)

STABILIZED STAGING AREA MAINTENANCE NOTES

- STABILIZED STAGING AREA SHALL BE ENLARGED IF NECESSARY TO CONTAIN PARKING, STORAGE, AND UNLOADING/LOADING OPERATIONS.
- THE STABILIZED STAGING AREA SHALL BE REMOVED AT THE END OF CONSTRUCTION. THE GRANULAR MATERIAL SHALL BE REMOVED OR, IF APPROVED BY THE LOCAL JURISDICTION, USED ON SITE, AND THE AREA COVERED WITH TOPSOIL, SEEDED AND MULCHED OR OTHERWISE STABILIZED IN A MANNER APPROVED BY LOCAL JURISDICTION.

NOTE: MANY MUNICIPALITIES PROHIBIT THE USE OF RECYCLED CONCRETE AS GRANULAR MATERIAL FOR STABILIZED STAGING AREAS DUE TO DIFFICULTIES WITH RE-ESTABLISHMENT OF VEGETATION IN AREAS WHERE RECYCLED CONCRETE WAS PLACED.

NOTE: MANY JURISDICTIONS HAVE BMP DETAILS THAT VARY FROM IUDFC STANDARD DETAILS. CONSULT WITH LOCAL JURISDICTIONS AS TO WHICH DETAIL SHOULD BE USED WHEN DIFFERENCES ARE NOTED.

(DETAILS ADAPTED FROM PARKER, COLORADO, NOT AVAILABLE IN AUTOCAD)

SSA-4 Urban Drainage and Flood Control District
Urban Storm Drainage Criteria Manual Volume 3 November 2010

SM-3

Construction Fence (CF)

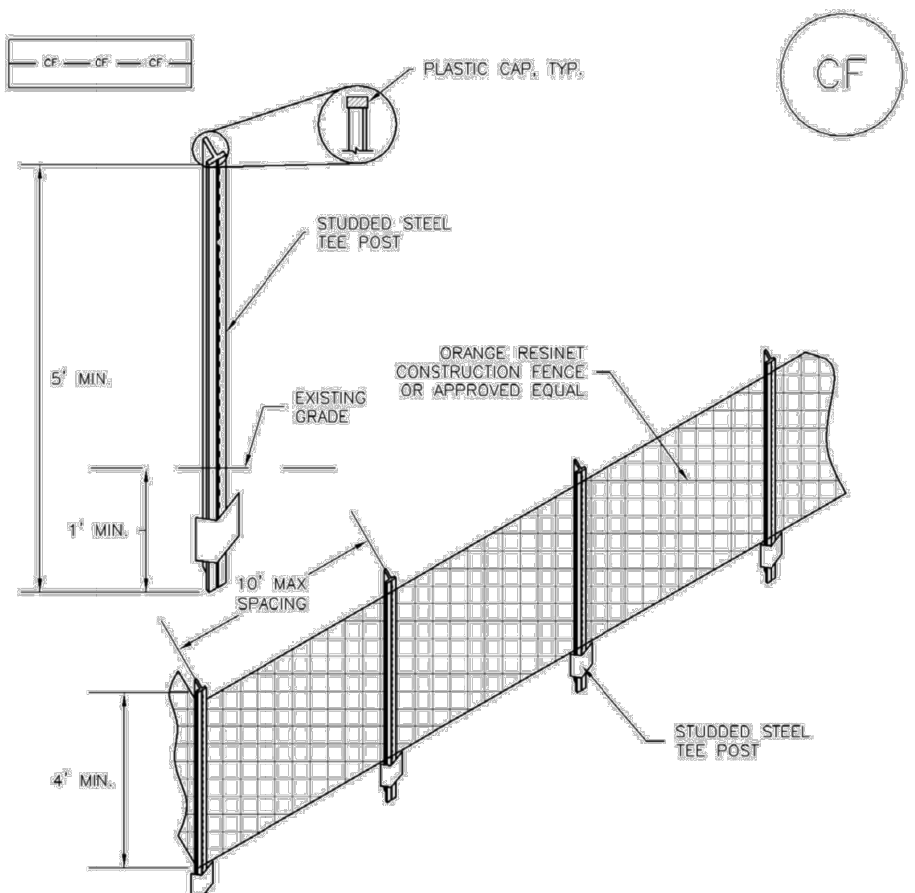

CF-1. PLASTIC MESH CONSTRUCTION FENCE

CONSTRUCTION FENCE INSTALLATION NOTES

- SEE PLAN VIEW FOR:
 - LOCATION OF CONSTRUCTION FENCE.
- CONSTRUCTION FENCE SHOWN SHALL BE INSTALLED PRIOR TO ANY LAND DISTURBING ACTIVITIES.
- CONSTRUCTION FENCE SHALL BE COMPOSED OF ORANGE, CONTRACTOR-GRADE MATERIAL THAT IS AT LEAST 4' HIGH. METAL POSTS SHOULD HAVE A PLASTIC CAP FOR SAFETY.
- STUDDED STEEL TEE POSTS SHALL BE UTILIZED TO SUPPORT THE CONSTRUCTION FENCE. MAXIMUM SPACING FOR STEEL TEE POSTS SHALL BE 10'.
- CONSTRUCTION FENCE SHALL BE SECURELY FASTENED TO THE TOP, MIDDLE, AND BOTTOM OF EACH POST.

CF-2 Urban Drainage and Flood Control District
Urban Storm Drainage Criteria Manual Volume 3 November 2010

CF CONSTRUCTION FENCE

Construction Fence (CF)

SM-3

CONSTRUCTION FENCE MAINTENANCE NOTES

- INSPECT BMPs EACH WORKDAY, AND MAINTAIN THEM IN EFFECTIVE OPERATING CONDITION. MAINTENANCE OF BMPs SHOULD BE PROACTIVE; NOT REACTIVE. INSPECT BMPs AS SOON AS POSSIBLE (AND ALWAYS WITHIN 24 HOURS) FOLLOWING A STORM THAT CAUSES SURFACE EROSION, AND PERFORM NECESSARY MAINTENANCE.
- FREQUENT OBSERVATIONS AND MAINTENANCE ARE NECESSARY TO MAINTAIN BMPs IN EFFECTIVE OPERATING CONDITION. INSPECTIONS AND CORRECTIVE MEASURES SHOULD BE DOCUMENTED THOROUGHLY.
- WHERE BMPs HAVE FAILED, REPAIR OR REPLACEMENT SHOULD BE INITIATED UPON DISCOVERY OF THE FAILURE.
- CONSTRUCTION FENCE SHALL BE REPAIRED OR REPLACED WHEN THERE ARE SIGNS OF DAMAGE SUCH AS RIPS OR SACS. CONSTRUCTION FENCE IS TO REMAIN IN PLACE UNTIL THE UPSTREAM DISTURBED AREA IS STABILIZED AND APPROVED BY THE LOCAL JURISDICTION.
- WHEN CONSTRUCTION FENCES ARE REMOVED, ALL DISTURBED AREAS ASSOCIATED WITH THE INSTALLATION, MAINTENANCE AND/OR REMOVAL OF THE FENCE SHALL BE COVERED WITH TOPSOIL, SEEDED AND MULCHED, OR OTHERWISE STABILIZED AS APPROVED BY LOCAL JURISDICTION.

NOTE: MANY JURISDICTIONS HAVE BMP DETAILS THAT VARY FROM IUDFC STANDARD DETAILS. CONSULT WITH LOCAL JURISDICTIONS AS TO WHICH DETAIL SHOULD BE USED WHEN DIFFERENCES ARE NOTED.

(DETAIL ADAPTED FROM TOWN OF PARKER, COLORADO, NOT AVAILABLE IN AUTOCAD)

November 2010 Urban Drainage and Flood Control District
Urban Storm Drainage Criteria Manual Volume 3 CF-3

FODS TRACKOUT CONTROL SYSTEM INSTALLATION

THE PURPOSE AND DESIGN OF THE FODS TRACKOUT CONTROL SYSTEM IS TO EFFECTIVELY REMOVE MOST SEDIMENT FROM VEHICLE TIRES AS THEY EXIT A DISTURBED AREA ONTO A PAVED STREET. THIS MANUAL IS A PLATFORM FROM WHICH TO INSTALL A FODS TRACKOUT CONTROL SYSTEM. NOTE: THIS IS NOT A ONE SIZE FITS ALL GUIDE. THE INSTALLATION MAY NEED TO BE MODIFIED TO MEET THE EXISTING CONDITIONS, EXPECTATIONS OF A PARTICULAR SITE, THIS IS A GUIDELINE. ULTIMATELY THE FODS TRACKOUT CONTROL SYSTEM SHOULD BE INSTALLED SAFELY WITH PROPER ANCHORING AND SIGNS PLACED AT THE ENTRANCE AND EXIT TO CAUTION USERS AND OTHERS.

- KEY NOTES:**
- FODS TRACKOUT CONTROL SYSTEM MAT.
 - FOSSIBILITY AREA.
 - ANCHOR POINT.
 - SILT OR FODS CONSTRUCTION FENCE.

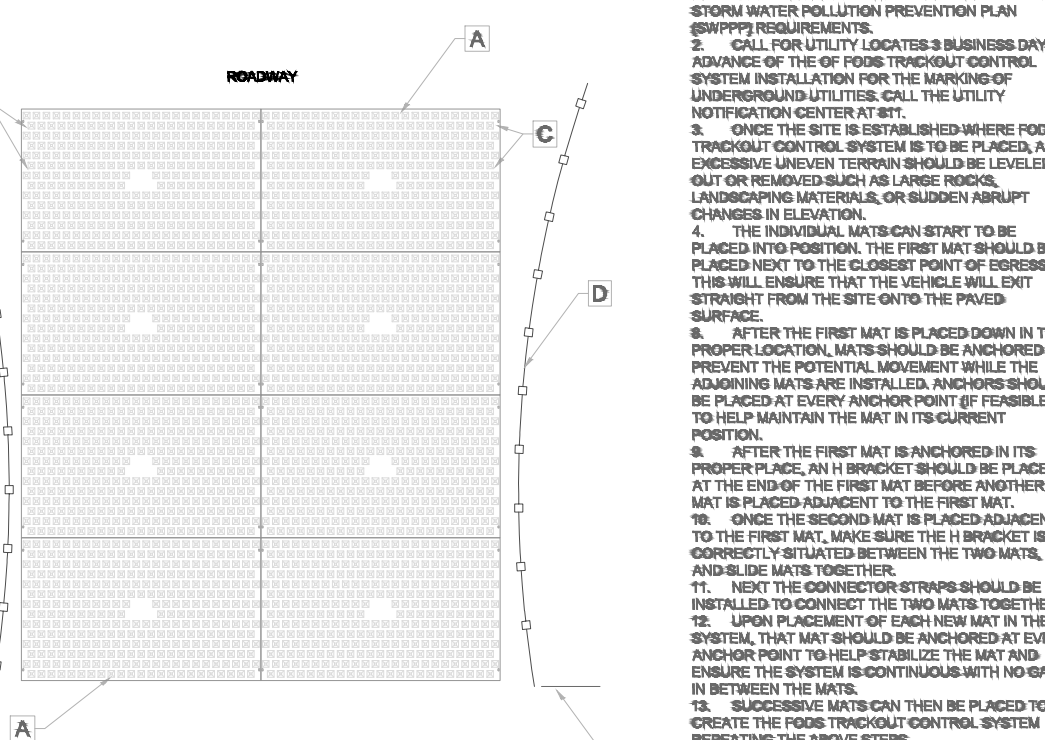

TYPICAL ENTRANCE LAYOUT

- INSTALLATION:**
- THE SITE WHERE THE FODS TRACKOUT CONTROL SYSTEM IS TO BE PLACED SHOULD CORRESPOND TO BEST MANAGEMENT PRACTICES AS MUCH AS POSSIBLE. THE SITE WHERE FODS TRACKOUT CONTROL SYSTEM IS PLACED SHOULD ALSO MEET OR EXCEED THE LOCAL JURISDICTION OR STATE WATER POLLUTION PREVENTION PLAN (SWPPP) REQUIREMENTS.
 - CALL FOR PERMITS. IF A UTILITY IS TO BE PLACED IN ADVANCE OF THE FODS TRACKOUT CONTROL SYSTEM INSTALLATION, CALL THE UTILITY NOTIFICATION CENTER AT 811.
 - ONCE THE SITE IS ESTABLISHED WHERE FODS TRACKOUT CONTROL SYSTEM IS TO BE PLACED, ANY EXCESSIVE UNLEVEL TERRAIN SHOULD BE LEVELLED OUT OR REPAIRED WITH A LARGE PNEUMATIC TIRE COMPACTOR OR ROLLER.
 - THE INDIVIDUAL MATS CAN START TO BE PLACED NEXT TO THE FIRST MAT. THE FIRST MAT SHOULD BE PLACED NEXT TO THE CLOSEST POINT OF EGRESS. THIS WILL ENSURE THAT THE VEHICLE WILL EXIT STRAIGHT FROM THE SITE ONTO THE PAVED SURFACE.
 - AFTER THE FIRST MAT IS PLACED DOWN IN THE PROPER LOCATION, THE FIRST MAT SHOULD BE PLACED NEXT TO THE CLOSEST POINT OF EGRESS. THIS WILL ENSURE THAT THE VEHICLE WILL EXIT STRAIGHT FROM THE SITE ONTO THE PAVED SURFACE.
 - AFTER THE FIRST MAT IS PLACED DOWN IN THE PROPER LOCATION, THE FIRST MAT SHOULD BE PLACED NEXT TO THE CLOSEST POINT OF EGRESS. THIS WILL ENSURE THAT THE VEHICLE WILL EXIT STRAIGHT FROM THE SITE ONTO THE PAVED SURFACE.
 - ONCE THE SECOND MAT IS PLACED ADJACENT TO THE FIRST MAT, MAKE SURE THE 11 H BENDS ARE CORRECTLY SITUATED BETWEEN THE TWO MATS, AND SECURE MATS TOGETHER.
 - NEXT THE CONNECTOR STRAPS SHOULD BE INSTALLED TO CONNECT THE TWO MATS TOGETHER.
 - UPON PLACEMENT OF EACH NEW MAT IN THE SYSTEM, THAT MAT SHOULD BE ANCHORED AT EVERY ANCHOR POINT TO HELP STABILIZE THE MAT AND ENSURE THE SYSTEM BECOMES TRACKED WITH VEHICLES IN BETWEEN THE MATS.
 - SUCCESSIVE MATS CAN THEN BE PLACED TO CREATE THE FODS TRACKOUT CONTROL SYSTEM REPRESENTING THE FODS STRIPS.
- USE AND MAINTENANCE:**
- VEHICLES SHOULD TRAVEL DOWN THE LENGTH OF THE TRACKOUT CONTROL SYSTEM FROM THE END OF THE MATS.
 - DRIVERS SHOULD TURN THE WHEELS OF THEIR VEHICLES SUCH THAT THE VEHICLE WILL MAKE A SHALLOW TURN ROADSIDE DOWN THE LENGTH OF THE FODS TRACKOUT CONTROL SYSTEM.
 - MATERIALS SHOULD BE CLEANED FROM THE VOIDS BETWEEN THE PYRAMIDS BECOME FULL OF SEDIMENT. TYPICALLY THIS WILL NEED TO BE PERFORMED WITHIN TWO WEEKS AFTER A STORM EVENT. MATERIALS IN THE VOIDS SHOULD BE CLEANED, EITHER MANUALLY OR MECHANICALLY.
 - THE USE OF ICE MELT, ROCK SALT, SAND, DE-ICER, ETC. SHOULD BE UTILIZED AS NECESSARY DURING THE WINTER MONTHS AND AFTER A SNOW EVENT TO PREVENT ICE BUILDUP.
- REMOVAL:**
- REMOVAL OF FODS TRACKOUT CONTROL SYSTEM IS REVERSE ORDER OF INSTALLATION.
 - STARTING WITH THE LAST MAT, THE MAT THAT IS PLACED AT THE FURTHEST POINT OF THE SITE OR THE MAT FURTHEST FROM THE EXIT OR PAVED SURFACE SHOULD BE REMOVED FIRST.
 - THE ANCHORS SHOULD BE REMOVED.
 - THE CONNECTOR STRAPS SHOULD BE UNLATCHED AT ALL LOCATIONS IN THE FODS TRACKOUT CONTROL SYSTEM.
 - STARTING WITH THE LAST MAT IN THE SYSTEM, EACH SUCCESSIVE MAT SHOULD THEN BE MOVED AND STACKED FOR CONSIDERATION FOR REUSE OR EDUCATOR ONTO A TRUCK FOR REMOVAL FROM THE SITE.

VTC VEHICLE TRACKING CONTROL

STORMWATER MANAGEMENT PLANS GENERAL NOTES

- DETAILS PROVIDED ON THIS SHEET ARE SUPERCEDED BY THE CITY OF ALBUQUERQUE CONSTRUCTION SITE MANUAL (2018, CURRENT EDITION). THE CONSTRUCTION SITE MANUAL GOVERNS IF ANY CONFLICTS ARISE.
- THE CONTRACTOR AND/OR AUTHORIZED AGENTS SHALL REMOVE ALL SEDIMENT, MUD, CONSTRUCTION DEBRIS, OR OTHER POTENTIAL POLLUTANTS THAT MAY HAVE BEEN DISCHARGED TO OR ACCUMULATE IN, THE FLOW LINES AND PUBLIC RIGHTS OF WAYS OF THE CITY AS A RESULT OF CONSTRUCTION ACTIVITIES ASSOCIATED WITH THIS SITE DEVELOPMENT OR CONSTRUCTION PROJECT. SAID REMOVAL SHALL BE CONDUCTED IN A TIMELY MANNER.
- ADDITIONAL EROSION AND SEDIMENT CONTROL MEASURES MAY BE REQUIRED OF THE OWNER AND HIS OR HER AGENTS DUE TO UNFORESEEN EROSION PROBLEMS OR IF THE SUBMITTED PLAN DOES NOT FUNCTION AS INTENDED. THE REQUIREMENTS OF THIS PLAN SHALL BE THE OBLIGATION OF THE PERMIT HOLDER UNTIL SUCH TIME AS THE PLAN IS PROPERLY COMPLETED AND THE PERMIT IS RELEASED.
- THE CONTRACTOR SHALL PREVENT SEDIMENT, DEBRIS AND ALL OTHER POLLUTANTS FROM ENTERING THE STORM SEWER SYSTEM DURING ALL DEMOLITION, EXCAVATION, TRENCHING, BORING, GRADING OR OTHER CONSTRUCTION OPERATIONS THAT ARE PART OF THIS PROJECT. THE CONTRACTOR SHALL BE HELD RESPONSIBLE FOR REMEDIATION OF ANY ADVERSE IMPACTS TO ADJACENT WATERWAYS, WETLANDS, ETC., RESULTING FROM WORK DONE AS PART OF THIS PROJECT.
- THE CONTRACTOR SHALL LOCATE, INSTALL, AND MAINTAIN ALL EROSION CONTROL AND WATER QUALITY BEST MANAGEMENT PRACTICES AS INDICATED IN THE APPROVED STORMWATER MANAGEMENT PLAN.
- THE DEVELOPER, GENERAL CONTRACTOR, GRADING CONTRACTOR AND/OR THEIR AUTHORIZED AGENTS SHALL INSURE THAT ALL LOADS OF CUT AND FILL MATERIAL IMPORTED TO OR EXPORTED FROM THIS SITE SHALL BE PROPERLY COVERED TO PREVENT LOSS OF THE MATERIAL DURING TRANSPORT ON PUBLIC RIGHTS OF WAY.
- SOILS THAT WILL BE STOCKPILED FOR MORE THAN 30 DAYS SHALL BE PROTECTED FROM WIND AND WATER EROSION WITHIN 14 DAYS OF STOCKPILE CONSTRUCTION. IF STOCKPILES ARE LOCATED WITHIN 100 FEET OF A DRAINAGEWAY, ADDITIONAL SEDIMENT CONTROLS SUCH AS TEMPORARY DIKES OR SILT FENCE SHALL BE REQUIRED.
- APPROVED EROSION AND SEDIMENT CONTROL BEST MANAGEMENT PRACTICES SHALL BE MAINTAINED AND KEPT IN GOOD REPAIR OF THE DURATION OF THIS PROJECT. ACCUMULATED SEDIMENT AND DEBRIS SHALL BE REMOVED FROM A BMP WHEN THE SEDIMENT OR DEBRIS ADVERSELY IMPACTS THE FUNCTIONING OF THE BMP.

BMP MAINTENANCE NOTE:
ALL EROSION AND SEDIMENT CONTROL PRACTICES AND OTHER PROTECTIVE MEASURES IDENTIFIED IN THE SWMP MUST BE MAINTAINED IN EFFECTIVE OPERATING CONDITION. PROPER SELECTION AND INSTALLATION OF BMP'S AND IMPLEMENTATION OF COMPREHENSIVE INSPECTION AND MAINTENANCE PROCEDURES IN ACCORDANCE WITH THE SWMP, SHOULD BE ADEQUATE TO MEET THIS CONDITION. BMP'S THAT ARE NOT ADEQUATELY MAINTAINED IN ACCORDANCE WITH GOOD ENGINEERING, HYDROLOGIC AND POLLUTION CONTROL PRACTICES, INCLUDING REMOVAL OF COLLECTED SEDIMENT OUTSIDE THE ACCEPTABLE TOLERANCES OF THE BMP'S, ARE CONSIDERED TO BE NO LONGER OPERATING EFFECTIVELY AND MUST BE ADDRESSED.



CALL NM ONE-CALL SYSTEM SEVEN (7) DAYS PRIOR TO ANY EXCAVATION



VERTICAL DATUM IS BASED UPON ALBUQUERQUE CONTROL SURVEY MONUMENT "ACS BM 24-L16". ELEVATION = 5191.31 FEET (NAVD 88)



DATE	DESCRIPTION	BY
09/09/2023	1ST TDC SUBMITTAL	DDJ
09/15/2025	2ND TDC SUBMITTAL	HCH
09/03/2025	3RD TDC SUBMITTAL	DDJ

NO.	DATE	CONTRACTOR:
1	09/09/2023	DDJ
2	09/15/2025	HCH
3	09/03/2025	DDJ

NO.	DATE	INSPECTOR'S ACCEPTANCE BY:
1	09/09/2023	DDJ
2	09/15/2025	HCH
3	09/03/2025	DDJ

NO.	DATE	FIELD VERIFICATION BY:
1	09/09/2023	DDJ
2	09/15/2025	HCH
3	09/03/2025	DDJ

**LOVELACE HEIGHTS ADDITION
CITY OF ALBUQUERQUE
2030 GIBSON BOULEVARD**

**EROSION CONTROL
DETAILS**

DESIGNED BY: DDJ
DRAWN BY: HCH
CHECKED BY: TDK
DATE: 09/03/2025

ZONE MAP NO. M-15 & L-15
CITY PROJECT NO.
SHEET NO. **C3.3**
PAGE 4 OF 4

Appendix B – Copy of 2022 CGP

(Note: The 2022 CGP is available at <https://www.epa.gov/npdes/2022-construction-general-permit-cgp>)

**National Pollutant Discharge Elimination System (NPDES)
Construction General Permit (CGP) for Stormwater Discharges from
Construction Activities**

In compliance with the provisions of the Clean Water Act, 33 U.S.C. §1251 et. seq., (hereafter CWA), as amended by the Water Quality Act of 1987, P.L. 100-4, "operators" of construction activities (defined in Appendix A) that meet the requirements of Part 1.1 of this National Pollutant Discharge Elimination System (NPDES) Construction General Permit (CGP), are authorized to discharge pollutants in accordance with the effluent limitations and conditions set forth herein. Permit coverage is required from the "commencement of construction activities" (see Appendix A) until one of the conditions for terminating CGP coverage has been met (see Part 8.2).

This permit becomes effective on 12:00 am, April 8, 2025.

This permit and the authorization to discharge expire at 11:59pm, February 16, 2027.

The 2022 CGP was modified to expand the list of areas eligible for coverage to include Lands of Exclusive Federal Jurisdiction in the U.S., to clarify the requirements that apply to projects that discharge to receiving waters within these areas, and to make corresponding changes in Appendices A, B, and D. See *2022 CGP Modification - Fact Sheet* for additional information.

Signed and issued this 8th day of April 2025

JAVIER LAUREANO PEREZ
Digitally signed by JAVIER LAUREANO PEREZ
Date: 2025.04.08 09:24:10 -04'00'

Javier Laureano Perez,
Director, Water Division, EPA Region 2.

Signed and issued this 8th day of April 2025

JEFFERY ROBICHAUD
Digitally signed by JEFFERY ROBICHAUD
Date: 2025.04.08 14:31:40 -05'00'

Jeffery Robichaud,
Director, Water Division, EPA Region 7.

Signed and issued this 8th day of April 2025

CARMEN GUERRERO PEREZ
Digitally signed by CARMEN GUERRERO PEREZ
Date: 2025.04.08 12:41:41 -04'00'

Carmen Guerrero Perez,
Director, Caribbean Environmental Protection Division,
EPA Region 2.

Signed and issued this 8th day of April 2025

STEPHANIE DEJONG
Digitally signed by STEPHANIE DEJONG
Date: 2025.04.08 09:32:38 -06'00'

Stephanie DeJong,
Manager, Clean Water Branch, EPA Region 8.

Signed and issued this 8th day of April 2025

KATHLENE BUTLER
Digitally signed by KATHLENE BUTLER
Date: 2025.04.08 14:05:04 -04'00'

Kathlene Butler,
Director, Water Division, EPA Region 4.

Signed and issued this 8th day of April 2025

 Digitally signed by TOMAS TORRES
Date: 2025.04.08 09:19:32 -07'00'

Tomas Torres,
Director, Water Division, EPA Region 9.

Signed and issued this 8th day of April 2025

TERA FONG
Digitally signed by TERA FONG
Date: 2025.04.08 15:01:22 -05'00'

Tera Fong,
Director, Water Division, EPA Region 5.

Signed and issued this 8th day of April 2025

MATHEW MARTINSON
Digitally signed by MATHEW MARTINSON
Date: 2025.04.08 14:41:11 -07'00'

Mathew Martinson,
Director, Water Division, EPA Region 10.

Signed and issued this 8th day of April 2025

TROY HILL
Digitally signed by TROY HILL
Date: 2025.04.08 14:04:26 -05'00'

Troy Hill,
Director, Water Division, EPA Region 6.

For EPA Regions 1 and 3, this modified permit becomes effective at 2:00 pm, June 10, 2025. This permit and the authorization to discharge expire at 11:59pm, February 16, 2027.

The 2022 CGP was modified to expand the list of areas eligible for coverage to include Lands of Exclusive Federal Jurisdiction in the U.S., to clarify the requirements that apply to projects that discharge to receiving waters within these areas, and to make corresponding changes in Appendices A, B, and D. See *2022 CGP Modification - Fact Sheet* for additional information.

Signed and issued this 10th day of June 10, 2025

**MARK
SANBORN**

Digitally signed by MARK
SANBORN
Date: 2025.06.10 11:00:04
-04'00'

Mark Sanborn
Regional Administrator, EPA Region 1

Signed and issued this 10th day of June 10, 2025

**MICHELLE
PRICE-FAY**

Digitally signed by MICHELLE
PRICE-FAY
Date: 2025.06.10 09:35:25
-04'00'

Michelle Price-Fay
Director, Water Division, EPA Region 3

CONTENTS

1	How to Obtain Coverage Under the Construction General Permit (CGP)	3
1.1	Eligibility Conditions	3
1.2	Types of Discharges Authorized	5
1.3	Prohibited Discharges.....	6
1.4	Submitting your Notice of Intent (NOI)	7
1.5	Requirement to Post a Notice of Your Permit Coverage.....	9
2	Technology-Based Effluent Limitations	10
2.1	General Stormwater Control Design, Installation, and Maintenance Requirements.....	10
2.2	Erosion and Sediment Control Requirements.....	12
2.3	Pollution Prevention Requirements	20
2.4	Construction Dewatering Requirements.....	24
3	Water Quality-Based Effluent Limitations	25
3.1	General Effluent Limitation to Meet Applicable Water Quality Standards	25
3.2	Water Quality-Based Conditions for Sites Discharging to Certain Impaired and High Quality Receiving Waters.....	25
3.3	Turbidity Benchmark Monitoring for Sites Discharging Dewatering Water To Protect the Water Quality of Sensitive Waters	26
4	Inspection Requirements	30
4.1	Person(s) Responsible for Conducting Site and Dewatering Inspections	30
4.2	Frequency of Inspections.....	30
4.3	Increase in Inspection Frequency for Certain Sites.	31
4.4	Reductions in Inspection Frequency	32
4.5	Areas that Must Be Inspected	33
4.6	Requirements for Inspections	34
4.7	Inspection Report.....	35
4.8	Inspections By EPA	36
5	Corrective Actions	36
5.1	Conditions Triggering Corrective Action.....	36
5.2	Corrective Action Deadlines	37
5.3	Corrective Action Required by EPA	38
5.4	Corrective Action Log	38
6	Stormwater Team Formation/Staff Training Requirements	38
6.1	Stormwater Team.....	38
6.2	General Training Requirements For Stormwater Team Members	39
6.3	Training Requirements For Persons Conducting Inspections	39

6.4	Stormwater Team's Access To Permit Documents	40
7	Stormwater Pollution Prevention Plan (SWPPP)	40
7.1	General Requirements	40
7.2	SWPPP Contents	41
7.3	On-Site Availability of Your SWPPP	48
7.4	SWPPP Modifications	48
8	How to Terminate Coverage	49
8.1	Minimum Information Required in NOT	49
8.2	Conditions for Terminating CGP Coverage	49
8.3	How to Submit Your NOT	50
8.4	Deadline for Submitting the NOT	51
8.5	Effective Date of Termination of Coverage	51
9	Permit Conditions Applicable to Specific States, Indian Country Lands, or Territories.....	51
9.1	EPA REGION 1	51
9.2	EPA REGION 2	60
9.3	EPA REGION 3	62
9.4	EPA REGION 4	63
9.5	EPA REGION 5	64
9.6	EPA REGION 6	70
9.7	EPA REGION 7	81
9.8	EPA REGION 8	81
9.9	EPA REGION 9	86
9.10	EPA REGION 10	89
10	ADDITIONAL Permit Conditions Applicable to LANDS OF EXCLUSIVE FEDERAL JURISDICTION	101
	Appendix A: Definitions	A-1
	Appendix B: Permit Areas Eligible for Coverage and EPA Regional Addresses.....	B-1
	Appendix C: Small Construction Waivers and Instructions	C-1
	Appendix D: Eligibility Procedures Relating to Threatened & Endangered Species Protection. D-1	
	Appendix E: Historic Property Screening Process	E-1
	Appendix F: Buffer Requirements	F-1
	Appendix G: Standard Permit Conditions.....	G-1
	Appendix H: Notice of Intent (NOI) Form and Instructions.....	H-1
	Appendix I: Notice of Termination (NOT) Form and Instructions.....	I-1
	Appendix J: Suggested Format for Request for Chemical Treatment	J-1
	Appendix K: Turbidity Benchmark Monitoring Report Form	K-1

1 HOW TO OBTAIN COVERAGE UNDER THE CONSTRUCTION GENERAL PERMIT (CGP)

To be covered under this permit, you must meet the eligibility conditions and follow the requirements for obtaining permit coverage in this Part.

1.1 ELIGIBILITY CONDITIONS

1.1.1 You are an “operator” of a construction site for which discharges will be covered under this permit. For the purposes of this permit and in the context of stormwater discharges associated with construction activity, an “operator” is any party associated with a construction project that meets either of the following two criteria:

- a.** The party has operational control over construction plans and specifications, including the ability to make modifications to those plans and specifications; or
- b.** The party has day-to-day operational control of those activities at a project that are necessary to ensure compliance with the permit conditions.

Where there are multiple operators associated with the same project, all operators must obtain permit coverage.¹ Subcontractors generally are not considered operators for the purposes of this permit.

1.1.2 Your site's construction activities:

- a.** Will disturb one or more acres of land, or will disturb less than one acre of land but are part of a common plan of development or sale (as defined in Appendix A) that will ultimately disturb one or more acres of land; or
- b.** Have been designated by EPA as needing permit coverage under 40 CFR § 122.26(a)(1)(v) or 40 CFR § 122.26(b)(15)(ii);

1.1.3 Your site is located in an area where EPA is the permitting authority and where coverage under this permit is available (see Appendix B).

1.1.4 Discharges from your site are not:

- a.** Already covered by a different NPDES permit for the same discharge; or
- b.** In the process of having coverage under a different NPDES permit for the same discharge denied, terminated, or revoked.^{2, 3}

1.1.5 You can demonstrate you meet one of the criteria in the Endangered Species Protection section of the Notice of Intent (NOI) that you submit for coverage under this permit, per Part 1.4, with respect to the protection of Federally listed endangered or threatened species and Federally designated critical habitat under the Endangered Species Act (ESA). If the EPA Regional Office grants you a waiver from electronic reporting per Part

¹ If the operator of a “construction support activity” (see Part 1.2.1c) is different than the operator of the main site, that operator must also obtain permit coverage. See Part 7.1 for clarification on the sharing of permit-related functions between and among operators on the same site and for conditions that apply to developing a SWPPP for multiple operators associated with the same site.

² Parts 1.1.4a and 1.1.4b do not include sites currently covered under the 2017 CGP that are in the process of obtaining coverage under this permit, nor sites covered under this permit that are transferring coverage to a different operator.

³ Notwithstanding a site being made ineligible for coverage under this permit because it falls under the description of Parts 1.1.4a or 1.1.4b, above, EPA may waive the applicable eligibility requirement after specific review if it determines that coverage under this permit is appropriate.

- 1.4.2, you must complete the ESA worksheet in Appendix D to demonstrate you meet one of the criteria and submit it with your paper NOI (Appendix I).
- 1.1.6** You have completed the screening process in Appendix E relating to the protection of historic properties; and
- 1.1.7** You have complied with all requirements in Part 9 imposed by the applicable State, Indian Tribe, or Territory in which your construction activities and/or discharge will occur.⁴
- 1.1.8** For “new sources” (as defined in Appendix A) only:
- a.** EPA has not, prior to authorization under this permit, determined that discharges from your site will not meet applicable water quality standards. Where such a determination is made prior to authorization, EPA may notify you that an individual permit application is necessary. However, EPA may authorize your coverage under this permit after you have included appropriate controls and implementation procedures designed to bring your discharge into compliance with this permit, specifically the requirement to meet water quality standards. In the absence of information demonstrating otherwise, EPA expects that compliance with the requirements of this permit, including the requirements applicable to such discharges in Part 3, will result in discharges that meet applicable water quality standards.
 - b.** Discharges from your site to a Tier 2, Tier 2.5, or Tier 3 water⁵ will not lower the water quality of the applicable water. In the absence of information demonstrating otherwise, EPA expects that compliance with the requirements of this permit, including the requirements applicable to such discharges in Part 3.2, will result in discharges that will not lower the water quality of such waters.
- 1.1.9** If you plan to add “cationic treatment chemicals” (as defined in Appendix A) to stormwater and/or authorized non-stormwater prior to discharge, you may not submit your NOI until you notify your applicable EPA Regional Office (see Appendix J) in advance and the EPA Regional Office authorizes coverage under this permit after you have included appropriate controls and implementation procedures designed to ensure that your use of cationic treatment chemicals will result in discharges that meet applicable water quality standards.

⁴ EPA notes that the requirements of Part 9 do not apply to projects within Lands of Exclusive Federal Jurisdiction.

⁵ Note: Your site will be considered to discharge to a Tier 2, Tier 2.5, or Tier 3 water if the first receiving water to which you discharge is identified by a State, Tribe, or EPA as a Tier 2, Tier 2.5, or Tier 3 water. For discharges that enter a storm sewer system prior to discharge, the first receiving water to which you discharge is the waterbody that receives the stormwater discharge from the storm sewer system. The current list of Tier 2, Tier 2.5, and Tier 3 waters located in the areas eligible for coverage under this permit can be found at <https://www.epa.gov/npdes/construction-general-permit-resources-tools-and-templates>. You can also use EPA's Discharge Mapping Tool (<https://www.epa.gov/npdes/epas-stormwater-discharge-mapping-tools>) to assist you in identifying whether any receiving waters to which you discharge are listed as impaired (and the pollutant for which it is impaired) and whether an approved total maximum daily load (TMDL) exists for that waterbody.

1.2 TYPES OF DISCHARGES AUTHORIZED⁶

1.2.1 The following stormwater discharges are authorized under this permit provided that appropriate stormwater controls are designed, installed, and maintained (see Parts 2 and 3):

- a.** Stormwater discharges, including stormwater runoff, snowmelt runoff, and surface runoff and drainage, associated with construction activity under 40 CFR § 122.26(b)(14) or § 122.26(b)(15)(i);
- b.** Stormwater discharges designated by EPA as needing a permit under 40 CFR § 122.26(a)(1)(v) or § 122.26(b)(15)(ii);
- c.** Stormwater discharges from on or off-site construction support activities (e.g., concrete or asphalt batch plants, equipment staging yards, material storage areas, excavated material disposal areas, borrow areas) provided that:
 - i.** The support activity is directly related to the construction site required to have permit coverage for stormwater discharges;
 - ii.** The support activity is not a commercial operation, nor does it serve multiple unrelated construction sites;
 - iii.** The support activity does not continue to operate beyond the completion of the construction activity at the site it supports; and
 - iv.** Stormwater controls are implemented in accordance with Part 2 and Part 3 for discharges from the support activity areas; and
- d.** Stormwater discharges from earth-disturbing activities associated with the construction of staging areas and the construction of access roads conducted prior to active mining.

1.2.2 The following non-stormwater discharges associated with your construction activity are authorized under this permit provided that, with the exception of water used to control dust and to irrigate vegetation in stabilized areas, these discharges are not routed to areas of exposed soil on your site and you comply with any applicable requirements for these discharges in Parts 2 and 3:

- a.** Discharges from emergency fire-fighting activities;
- b.** Fire hydrant flushings;
- c.** Landscape irrigation;
- d.** Water used to wash vehicles and equipment, provided that there is no discharge of soaps, solvents, or detergents used for such purposes;
- e.** Water used to control dust;
- f.** Potable water including uncontaminated water line flushings;

⁶ See "Discharge" as defined in Appendix A. Note: Any discharges not expressly authorized in this permit cannot become authorized or shielded from liability under CWA Section 402(k) by disclosure to EPA, State, or local authorities after issuance of this permit via any means, including the Notice of Intent (NOI) to be covered by the permit, the SWPPP, or during an inspection.

- g.** External building washdown, provided soaps, solvents, and detergents are not used, and external surfaces do not contain hazardous substances (as defined in Appendix A) (e.g., paint or caulk containing polychlorinated biphenyls (PCBs));
 - h.** Pavement wash waters, provided spills or leaks of toxic or hazardous substances have not occurred (unless all spill material has been removed) and where soaps, solvents, and detergents are not used. You are prohibited from directing pavement wash waters directly into any receiving water, storm drain inlet, or constructed or natural site drainage features, unless the feature is connected to a sediment basin, sediment trap, or similarly effective control;
 - i.** Uncontaminated air conditioning or compressor condensate;
 - j.** Uncontaminated, non-turbid discharges of ground water or spring water;
 - k.** Foundation or footing drains where flows are not contaminated with process materials such as solvents or contaminated ground water; and
 - l.** Uncontaminated construction dewatering water⁷ discharged in accordance with Part 2.4.
- 1.2.3** Also authorized under this permit are discharges of stormwater listed above in Part 1.2.1, or authorized non-stormwater discharges listed above in Part 1.2.2, commingled with a discharge authorized by a different NPDES permit and/or a discharge that does not require NPDES permit authorization.

1.3 PROHIBITED DISCHARGES⁸

The discharges listed in this Part are prohibited outright or authorized only under the identified conditions. To prevent the discharges in Parts 1.3.1 through 1.3.5, operators must comply with the applicable pollution prevention requirements in Part 2.3 or ensure the discharge is authorized by another NPDES permit consistent with Part 1.2.3 for commingled discharges.

- 1.3.1** Wastewater from washout of concrete, unless managed by an appropriate control as described in Part 2.3.4;
- 1.3.2** Wastewater from washout and/or cleanout of stucco, paint, form release oils, curing compounds, and other construction materials;
- 1.3.3** Fuels, oils, or other pollutants used in vehicle and equipment operation and maintenance;
- 1.3.4** Soaps, solvents, or detergents used in vehicle and equipment washing or external building washdown; and
- 1.3.5** Toxic or hazardous substances from a spill or other release.

⁷ EPA notes that operators may need to comply with additional procedures to verify that the dewatering discharge is uncontaminated. Operators should review Part 9 to determine if any of these requirements apply to their discharge and should ensure that they have complied with any State, Tribal, or local dewatering requirements that apply.

⁸ EPA includes these prohibited non-stormwater discharges here as a reminder to the operator that the only non-stormwater discharges authorized by this permit are at Part 1.2.2. Any unauthorized non-stormwater discharges must be covered under an individual permit or alternative general permit.

1.4 SUBMITTING YOUR NOTICE OF INTENT (NOI)

All “operators” (as defined in Appendix A) associated with your construction site who meet the Part 1.1 eligibility conditions, and who seek coverage under this permit, must submit to EPA a complete and accurate NOI in accordance with the deadlines in Table 1 prior to commencement of construction activities (as defined in Appendix A).

Exception: If you are conducting construction activities in response to a public emergency (e.g., mud slides, earthquake, extreme flooding conditions, widespread disruption in essential public services), and the related work requires immediate authorization to avoid imminent endangerment to human health, public safety, or the environment, or to reestablish essential public services, you may discharge on the condition that a complete and accurate NOI is submitted within 30 calendar days after commencing construction activities (see Table 1) establishing that you are eligible for coverage under this permit. You must also provide documentation in your Stormwater Pollution Prevention Plan (SWPPP) to substantiate the occurrence of the public emergency pursuant to Part 7.2.3i.

1.4.1 Prerequisite for Submitting Your NOI

You must develop a SWPPP consistent with Part 7 before submitting your NOI for coverage under this permit.

1.4.2 How to Submit Your NOI

You must use EPA’s NPDES eReporting Tool (NeT) to electronically prepare and submit your NOI for coverage under the 2022 CGP unless you received a waiver from your applicable EPA Regional Office.

To access NeT, go to <https://cdx.epa.gov/cdx>.

Waivers from electronic reporting may be granted based on one of the following conditions:

- a. If your operational headquarters is physically located in a geographic area (i.e., ZIP code or census tract) that is identified as under-served for broadband Internet access in the most recent report from the Federal Communications Commission; or
- b. If you have limitations regarding available computer access or computer capability.

If the EPA Regional Office grants you approval to use a paper NOI, and you elect to use it, you must complete the form in Appendix H.

1.4.3 Deadlines for Submitting Your NOI and Your Official Date of Permit Coverage

Table 1 provides the deadlines for submitting your NOI and the official start date of your permit coverage, which differ depending on when you commence construction activities.

Table 1 NOI Submittal Deadlines and Official Start Date for Permit Coverage.

Type of Operator	NOI Submittal Deadline⁹	Permit Authorization Date¹⁰
Operator of a new site (i.e., a site where construction activities commence on or after February 17, 2022)	At least 14 calendar days before commencing construction activities.	14 calendar days after EPA notifies you that it has received a complete NOI, unless EPA notifies you that your authorization is delayed or denied.
Operator of an existing site (i.e., a site with 2017 CGP coverage where construction activities commenced prior to February 17, 2022)	No later than May 18, 2022.	14 calendar days after EPA notifies you that it has received a complete NOI, unless EPA notifies you that your authorization is delayed or denied. Provided you submit your NOI no later than May 18, 2022, your authorization under the 2017 CGP is automatically continued until you have been granted coverage under this permit or an alternative NPDES permit, or coverage is otherwise terminated.
New operator of a permitted site (i.e., an operator that through transfer of ownership and/or operation replaces the operator of an already permitted construction site that is either a "new site" or an "existing site")	At least 14 calendar days before the date the transfer to the new operator will take place.	14 calendar days after EPA notifies you that it has received a complete NOI, unless EPA notifies you that your authorization is delayed or denied.
Operator of an "emergency-related project" (i.e., a project initiated in response to a public emergency (e.g., mud slides, earthquake, extreme flooding conditions, disruption in essential public services), for which the related work requires immediate authorization to avoid imminent endangerment to human health or the environment, or to reestablish essential public services)	No later than 30 calendar days after commencing construction activities.	You are considered provisionally covered under the terms and conditions of this permit immediately, and fully covered 14 calendar days after EPA notifies you that it has received a complete NOI, unless EPA notifies you that your authorization is delayed or denied.

⁹ If you miss the deadline to submit your NOI, any and all discharges from your construction activities will continue to be unauthorized under the CWA until they are covered by this or a different NPDES permit. EPA may take enforcement action for any unpermitted discharges that occur between the commencement of construction activities and discharge authorization.

¹⁰ Discharges are not authorized if your NOI is incomplete or inaccurate or if you are not eligible for permit coverage.

1.4.4 Modifying your NOI

If after submitting your NOI you need to correct or update any fields, you may do so by submitting a "Change NOI" form using NeT. Waivers from electronic reporting may be granted as specified in Part 1.4.2. If the EPA Regional Office has granted you approval to submit a paper NOI modification, you may indicate any NOI changes on the same NOI form in Appendix H.

When there is a change to the site's operator, the new operator must submit a new NOI, and the previous operator must submit a Notice of Termination (NOT) form as specified in Part 8.3.

The following modifications to an NOI form will result in a 14-day review process:

- Changes to the name of the operator;
- Changes to the project or site name;
- Changes to the estimated area to be disturbed;
- Changes to the name of the receiving water¹¹, or additions to the applicable receiving waters;
- Changes to eligibility information related to endangered species protection or historic preservation;
- Changes to information provided related to the use of chemical treatment at your site; and
- Changes to answers provided regarding the demolition of structures over 10,000 square feet of floor space built or renovated before January 1, 1980.

During the 14-day review process, you may continue to operate based on the information provided in your original NOI, but you must wait until the review period has ended before you may commence or continue activities on any portion of your site that would be affected by any of the above modifications, unless EPA notifies you that the authorization is delayed or denied.

1.4.5 Your Official End Date of Permit Coverage

Once covered under this permit, your coverage will last until the date that:

- a. You terminate permit coverage consistent with Part 8; or
- b. You receive permit coverage under a different NPDES permit or a reissued or replacement version of this permit after expiring on February 16, 2027; or
- c. You fail to submit an NOI for coverage under a reissued or replacement version of this permit before the deadline for existing construction sites where construction activities continue after this permit has expired.

1.5 REQUIREMENT TO POST A NOTICE OF YOUR PERMIT COVERAGE

You must post a sign or other notice of your permit coverage at a safe, publicly accessible location in close proximity to the construction site. The notice must be located so it is visible from the public road that is nearest to the active part of the construction

¹¹ As defined in Appendix A, a "receiving water" is "a "Water of the United States" as defined in 40 CFR §122.2 into which the regulated stormwater discharges.

site, and it must use a font large enough to be readily viewed from a public right-of-way.¹² At a minimum, the notice must include:

- a. The NPDES ID (i.e., permit tracking number assigned to your NOI and the EPA webpage where a copy of the NOI can be found (<https://permitsearch.epa.gov/epermit-search/ui/search>));
- b. A contact name and phone number for obtaining additional construction site information;
- c. The Uniform Resource Locator (URL) for the SWPPP (if available), or the following statement: "If you would like to obtain a copy of the Stormwater Pollution Prevention Plan (SWPPP) for this site, contact the EPA Regional Office at [include the appropriate CGP Regional Office contact information found at <https://www.epa.gov/npdes/contact-us-stormwater#regional>];" and
- d. The following statement "If you observe indicators of stormwater pollutants in the discharge or in the receiving water, contact the EPA through the following website: <https://www.epa.gov/enforcement/report-environmental-violations>."

2 TECHNOLOGY-BASED EFFLUENT LIMITATIONS

You must comply with the following technology-based effluent limitations in this Part for all authorized discharges.¹³

2.1 GENERAL STORMWATER CONTROL DESIGN, INSTALLATION, AND MAINTENANCE REQUIREMENTS

You must design, install, and maintain stormwater controls required in Parts 2.2, 2.3, and 2.4 to minimize the discharge of pollutants in stormwater from construction activities.¹⁴ To meet this requirement, you must:

2.1.1 Account for the following factors in designing your stormwater controls:

- a. The expected amount, frequency, intensity, and duration of precipitation;¹⁵
- b. The nature of stormwater runoff (i.e., flow) and run-on at the site, including factors such as expected flow from impervious surfaces, slopes, and site drainage features. You must design stormwater controls to control stormwater volume, velocity, and peak flow rates to minimize discharges of pollutants in stormwater and to minimize channel and streambank erosion and scour in the immediate vicinity of discharge points; and
- c. The soil type and range of soil particle sizes expected to be present on the site.

¹² If the active part of the construction site is not visible from a public road, then place the notice of permit coverage in a position that is visible from the nearest public road and as close as possible to the construction site.

¹³ For each of the effluent limits in Part 2, as applicable to your site, you must include in your SWPPP (1) a description of the specific control(s) to be implemented to meet the effluent limit; (2) any applicable design specifications; (3) routine maintenance specifications; and (4) the projected schedule for installation/implementation. See Part 7.2.6.

¹⁴ The permit does not recommend or endorse specific products or vendors.

¹⁵ Stormwater controls must be designed using the most recent data available to account for recent precipitation patterns and trends.

If your site is exposed to or has previously experienced major storms, such as hurricanes, storm surge, extreme/heavy precipitation, and flood events, you should also include consideration of and contingencies for whether implementing structural improvements, enhanced/resilient stormwater controls, and other mitigation measures may help minimize impacts from stormwater discharges from such major storm events.

2.1.2 Design and install all stormwater controls in accordance with good engineering practices, including applicable design specifications.¹⁶

2.1.3 Complete installation of stormwater controls by the time each phase of construction activities has begun.

- a. By the time construction activity in any given portion of the site begins, install and make operational any downgradient sediment controls (e.g., buffers, perimeter controls, exit point controls, storm drain inlet protection) that control discharges from the initial site clearing, grading, excavating, and other earth-disturbing activities.¹⁷
- b. Following the installation of these initial controls, install and make operational all stormwater controls needed to control discharges prior to subsequent earth-disturbing activities.

2.1.4 Ensure all stormwater controls are maintained and remain in effective operating condition during permit coverage and are protected from activities that would reduce their effectiveness.

- a. Comply with any specific maintenance requirements for the stormwater controls listed in this permit, as well as any recommended by the manufacturer.¹⁸
- b. If at any time you find that a stormwater control needs routine maintenance (i.e., minor repairs or other upkeep performed to ensure the site's stormwater controls remain in effective operating condition, not including significant repairs or the need to install a new or replacement control), you must immediately initiate the needed work, and complete such work by the close of the next business day. If it is infeasible to complete the routine maintenance by the close of the next business day, you must document why this is the case and why the repair or other upkeep to be performed should still be considered routine maintenance in your inspection report under Part 4.7.1c and complete such work no later than seven (7) calendar days from the time of discovery of the condition requiring maintenance.
- c. If you must repeatedly (i.e., three (3) or more times) make the same routine maintenance fixes to the same control at the same location, even if the fix can be completed by the close of the next business day, you must either:
 - i. Complete work to fix any subsequent repeat occurrences of this same problem under the corrective action procedures in Part 5, including keeping any records

¹⁶ Design specifications may be found in manufacturer specifications and/or in applicable erosion and sediment control manuals or ordinances. Any departures from such specifications must reflect good engineering practices and must be explained in your SWPPP. You must also comply with any additional design and installation requirements specified for the effluent limits in Parts 2.2, 2.3, and 2.4.

¹⁷ Note that the requirement to install stormwater controls prior to each phase of construction activities for the site does not apply to the earth disturbance associated with the actual installation of these controls. Operators should take all reasonable actions to minimize the discharges of pollutants during the installation of stormwater controls.

¹⁸ Any departures from such maintenance recommendations made by the manufacturer must reflect good engineering practices and must be explained in your SWPPP.

of the condition and how it was corrected under Part 5.4; or

- ii. Document in your inspection report under Part 4.7.1c why the specific reoccurrence of this same problem should still be addressed as a routine maintenance fix under this Part.¹⁹
- d. If at any time you find that a stormwater control needs a significant repair or that a new or replacement control is needed, you must comply with the corrective action deadlines for completing such work in in Part 5.2.1c.

2.2 EROSION AND SEDIMENT CONTROL REQUIREMENTS

You must implement erosion and sediment controls in accordance with the following requirements to minimize the discharge of pollutants in stormwater from construction activities.

2.2.1 Provide and maintain natural buffers and/or equivalent erosion and sediment controls for discharges to any receiving waters that is located within 50 feet of the site's earth disturbances.

- a. **Compliance Alternatives.** For any discharges to receiving waters located within 50 feet of your site's earth disturbances, you must comply with one of the following alternatives:
 - i. Provide and maintain a 50-foot undisturbed natural buffer; or
 - ii. Provide and maintain an undisturbed natural buffer that is less than 50 feet and is supplemented by erosion and sediment controls that achieve, in combination, the sediment load reduction equivalent to a 50-foot undisturbed natural buffer; or
 - iii. If infeasible to provide and maintain an undisturbed natural buffer of any size, implement erosion and sediment controls to achieve the sediment load reduction equivalent to a 50-foot undisturbed natural buffer.

See Appendix F, Part F.2 for additional conditions applicable to each compliance alternative.

- b. **Exceptions.** See Appendix F, Part F.2 for exceptions to the compliance alternatives.

2.2.2 Direct stormwater to vegetated areas and maximize stormwater infiltration and filtering to reduce pollutant discharges, unless infiltration would be inadvisable due to the underlying geology (e.g., karst topography) and ground water contamination concerns, or infeasible due to site conditions.²⁰

¹⁹ Such documentation could include, for example, that minor repairs completed within the required timeframe are all that is necessary to ensure that the stormwater control continues to operate as designed and installed and that the stormwater control remains appropriate for the flow reaching it.

²⁰ Operators should consider whether factors such as specific contaminant concerns from the construction site, the underlying soils or geology, hydrology, depth to the ground water table, or proximity to source water or wellhead protection area(s) make the site unsuitable for infiltrating construction stormwater. Site conditions that may be of particular concern include proximity to: a current or future drinking water aquifer; a drinking water well or spring (including private/household wells); highly conductive geology such as karst; known pollutant hot spots, such as hazardous waste sites, landfills, gas stations, brownfields; an on-site sewage system or underground storage tank; or soils that do not allow for infiltration. Operators may find it helpful to consult EPA's [Drinking Water Mapping Application to Protect Source Waters \(DWMAPS\)](#). DWMAPS is an online mapping tool that can be used to locate drinking water providers, potential sources of contamination, polluted waterways, and information on protection initiatives in the site area.

2.2.3 Install sediment controls along any perimeter areas of the site that are downslope from any exposed soil or other disturbed areas.²¹

- a. The perimeter control must be installed upgradient of any natural buffers established under Part 2.2.1, unless the control is being implemented pursuant to Part 2.2.1a.ii-iii;
- b. To prevent stormwater from circumventing the edge of the perimeter control, install the perimeter control on the contour of the slope and extend both ends of the control up slope (e.g., at 45 degrees) forming a crescent rather than a straight line;
- c. After installation, to ensure that perimeter controls continue to work effectively:
 - i. Remove sediment before it has accumulated to one-half of the above-ground height of any perimeter control; and
 - ii. After a storm event, if there is evidence of stormwater circumventing or undercutting the perimeter control, extend controls and/or repair undercut areas to fix the problem.
- d. **Exception.** For areas at “linear construction sites” (as defined in Appendix A) where perimeter controls are infeasible (e.g., due to a limited or restricted right-of-way), implement other practices as necessary to minimize pollutant discharges to perimeter areas of the site.

2.2.4 Minimize sediment track-out.

- a. Restrict vehicle use to properly designated exit points;
- b. Use appropriate stabilization techniques²² at all points that exit onto paved roads;
 - i. **Exception:** Stabilization is not required for exit points at linear utility construction sites that are used only episodically and for very short durations over the life of the project, provided other exit point controls²³ are implemented to minimize sediment track-out;
- c. Implement additional track-out controls²⁴ as necessary to ensure that sediment removal occurs prior to vehicle exit; and
- d. Where sediment has been tracked-out from your site onto paved roads, sidewalks, or other paved areas outside of your site, remove the deposited sediment by the end of the same business day in which the track-out occurs or by the end of the next business day if track-out occurs on a non-business day. Remove the track-out by sweeping, shoveling, or vacuuming these surfaces, or by using other similarly effective means of sediment removal. You are prohibited from hosing or sweeping tracked-out

²¹ Examples of perimeter controls include filter berms; different types of silt fence such as wire-backed silt fence, super silt fence, or multi-layer geotextile silt fence; compost filter socks; gravel barriers; and temporary diversion dikes.

²² Examples of appropriate stabilization techniques include the use of aggregate stone with an underlying geotextile or non-woven filter fabric, and turf mats.

²³ Examples of other exit point controls include preventing the use of exit points during wet periods; minimizing exit point use by keeping vehicles on site to the extent possible; limiting exit point size to the width needed for vehicle and equipment usage; using scarifying and compaction techniques on the soil; and avoiding establishing exit points in environmentally sensitive areas (e.g., karst areas; steep slopes).

²⁴ Examples of additional track-out controls include the use of wheel washing, rumble strips, and rattle plates.

sediment into any constructed or natural site drainage feature, storm drain inlet, or receiving water.²⁵

2.2.5 Manage stockpiles or land clearing debris piles composed, in whole or in part, of sediment and/or soil:²⁶

- a. Locate the piles outside of any natural buffers established under Part 2.2.1 and away from any constructed or natural site drainage features, storm drain inlets, and areas where stormwater flow is concentrated;
- b. Install a sediment barrier along all downgradient perimeter areas of stockpiled soil or land clearing debris piles;²⁷
- c. For piles that will be unused for 14 or more days, provide cover²⁸ or appropriate temporary stabilization (consistent with Part 2.2.14);
- d. You are prohibited from hosing down or sweeping soil or sediment accumulated on pavement or other impervious surfaces into any constructed or natural site drainage feature, storm drain inlet, or receiving water.

2.2.6 Minimize dust. On areas of exposed soil, minimize dust through the appropriate application of water or other dust suppression techniques to control the generation of pollutants that could be discharged in stormwater from the site.

2.2.7 Minimize steep slope disturbances. Minimize the disturbance of “steep slopes” (as defined in Appendix A).²⁹

2.2.8 Preserve native topsoil, unless infeasible.³⁰

2.2.9 Minimize soil compaction.³¹ In areas of your site where final vegetative stabilization will occur or where infiltration practices will be installed:

²⁵ Fine grains that remain visible (e.g., staining) on the surfaces of off-site streets, other paved areas, and sidewalks after you have implemented sediment removal practices are not a violation of Part 2.2.4.

²⁶ The requirements in Part 2.2.5 do not apply to the storage of rock, such as rip rap, landscape rock, pipe bedding gravel, and boulders. Refer to Part 2.3.3a for the requirements that apply to these types of materials.

²⁷ Examples of sediment barriers include berms, dikes, fiber rolls, silt fences, sandbags, gravel bags, or straw bale.

²⁸ Examples of cover include tarps, blown straw and hydroseeding.

²⁹ Where disturbance to steep slopes cannot be avoided, operators should consider implementing controls suitable for steep slope disturbances that are effective at minimizing erosion and sediment discharge (e.g., preservation of existing vegetation, hydraulic mulch, geotextiles and mats, compost blankets, earth dikes or drainage swales, terraces, velocity dissipation devices). To identify slopes and soil types that are of comparatively higher risk for sediment discharge in areas of the country where the CGP is in effect, operators can use the tables in Appendix F (see Tables F-2 thru F-6).

³⁰ Stockpiling topsoil at off-site locations, or transferring topsoil to other locations, is an example of a practice that is consistent with the requirements in Part 2.2.8. Preserving native topsoil is not required where the intended function of a specific area of the site dictates that the topsoil be disturbed or removed. For example, some sites may be designed to be highly impervious after construction, and therefore little or no vegetation is intended to remain, or may not have space to stockpile native topsoil on site for later use, in which case it may not be feasible to preserve topsoil.

³¹ Minimizing soil compaction is not required where the intended function of a specific area of the site dictates that it be compacted.

- a. Restrict vehicle and equipment use in these locations to avoid soil compaction; and
- b. Before seeding or planting areas of exposed soil that have been compacted, use techniques that rehabilitate and condition the soils as necessary to support vegetative growth.

2.2.10 Protect storm drain inlets.

- a. Install inlet protection measures that remove sediment from discharges prior to entry into any storm drain inlet that carries stormwater from your site to a receiving water, provided you have authority to access the storm drain inlet.³² Inlet protection measures are not required for storm drain inlets that are conveyed to a sediment basin, sediment trap, or similarly effective control; and
- b. Clean, or remove and replace, the inlet protection measures as sediment accumulates, the filter becomes clogged, and/or performance is compromised. Where there is evidence of sediment accumulation adjacent to the inlet protection measure, remove the deposited sediment by the end of the same business day in which it is found or by the end of the following business day if removal by the same business day is not feasible.

2.2.11 Control stormwater discharges, including both peak flowrates and total stormwater volume, to minimize channel and streambank erosion and scour in the immediate vicinity of discharge points.³³

2.2.12 If you install a sediment basin or similar impoundment:

- a. Situate the basin or impoundment outside of any receiving water, and any natural buffers established under Part 2.2.1;
- b. Design the basin or impoundment to avoid collecting water from wetlands;
- c. Design the basin or impoundment to provide storage for either:
 - i. The calculated volume of runoff from a 2-year, 24-hour storm;³⁴ or
 - ii. 3,600 cubic feet per acre drained.
- d. Utilize outlet structures that withdraw water from the surface of the sediment basin or similar impoundment, unless infeasible;³⁵
- e. Use erosion controls and velocity dissipation devices to prevent erosion at inlets and outlets; and

³² Inlet protection measures can be removed in the event of flood conditions or to prevent erosion.

³³ Examples of stormwater controls that can be used to comply with this requirement include the use of erosion controls and/or velocity dissipation devices (e.g., check dams, sediment traps), within and along the length of a constructed site drainage feature and at the outfall to slow down stormwater.

³⁴ Operators may refer to <https://www.epa.gov/npdes/construction-general-permit-resources-tools-and-templates> for guidance on determining the volume of precipitation associated with their site's local 2-year, 24-hour storm event.

³⁵ The circumstances in which it is infeasible to design outlet structures in this manner are rare. Exceptions may include areas with extended cold weather, where using surface outlets may not be feasible during certain time periods (although they must be used during other periods). If you determine that it is infeasible to meet this requirement, you must provide documentation in your SWPPP to support your determination, including the specific conditions or time periods when this exception will apply.

- f. Remove accumulated sediment to maintain at least one-half of the design capacity and conduct all other appropriate maintenance to ensure the basin or impoundment remains in effective operating condition.

2.2.13 If using treatment chemicals (e.g., polymers, flocculants, coagulants):

- a. **Use conventional erosion and sediment controls before and after the application of treatment chemicals.** Chemicals may only be applied where treated stormwater is directed to a sediment control (e.g., *sediment basin, perimeter control*) before discharge.
- b. **Select appropriate treatment chemicals.** Chemicals must be appropriately suited to the types of soils likely to be exposed during construction and present in the discharges being treated (i.e., *the expected turbidity, pH, and flow rate of stormwater flowing into the chemical treatment system or area*).
- c. **Minimize discharge risk from stored chemicals.** Store all treatment chemicals in leak-proof containers that are kept under storm-resistant cover and surrounded by secondary containment structures (e.g., *spill berms, dikes, spill containment pallets*), or provide equivalent measures designed and maintained to minimize the potential discharge of treatment chemicals in stormwater or by any other means (e.g., *storing chemicals in a covered area, having a spill kit available on site and ensuring personnel are available to respond expeditiously in the event of a leak or spill*).
- d. **Comply with State/local requirements.** Comply with applicable State and local requirements regarding the use of treatment chemicals.
- e. **Use chemicals in accordance with good engineering practices and specifications of the chemical provider/supplier.** Use treatment chemicals and chemical treatment systems in accordance with good engineering practices, and with dosing specifications and sediment removal design specifications provided by the provider/supplier of the applicable chemicals, or document in your SWPPP specific departures from these specifications and how they reflect good engineering practice.
- f. **Ensure proper training.** Ensure all persons who handle and use treatment chemicals at the construction site are provided with appropriate, product-specific training prior to beginning application of treatment chemicals. Among other things, the training must cover proper dosing requirements.
- g. **Perform additional measures specified by the EPA Regional Office for the authorized use of cationic chemicals.** If you have been authorized to use cationic chemicals at your site pursuant to Part 1.1.9, you must perform all additional measures as conditioned by your authorization to ensure the use of such chemicals will not result in discharges that do not meet water quality standards.

2.2.14 Stabilize exposed portions of the site. Implement and maintain stabilization measures (e.g., *seeding protected by erosion controls until vegetation is established*,³⁶ *sodding, mulching, erosion control blankets, hydromulch, gravel*) that minimize erosion from any areas of exposed soil on the site in accordance with Part.

³⁶ If you will be evaluating the use of some type of erosion control netting to the site as part of your site stabilization, EPA encourages you to consider employing products that have been shown to minimize

a. Stabilization Deadlines:³⁷**Table 2 Deadlines for Initiating and Completing Site Stabilization.**

Total Amount of Land Disturbance Occurring At Any One Time ³⁸	Deadline
i. Five acres or less (≤ 5.0) Note: this includes sites disturbing more than five acres (>5.0) total over the course of a project, but that limit disturbance at any one time (i.e., phase the disturbance) to five acres or less (≤ 5.0)	<ul style="list-style-type: none"> • Initiate the installation of stabilization measures immediately³⁹ in any areas of exposed soil where construction activities have permanently ceased or will be temporarily inactive for 14 or more calendar days;⁴⁰ and • Complete the installation of stabilization measures as soon as practicable, but no later than 14 calendar days

impacts on wildlife. For instance, the U.S. Fish & Wildlife Service provides recommendations on the type of netting practices that are considered “wildlife friendly,” including those that use natural fiber or 100 percent biodegradable materials and that use a loose weave with a non-welded, movable jointed netting, as well as those products that are not wildlife friendly including square plastic netting that are degradable (e.g., photodegradable, UV-degradable, oxo-degradable), netting made from polypropylene, nylon, polyethylene, or polyester. Other recommendations include removing the netting product when it is no longer needed. See https://www.fws.gov/midwest/eastlansing/library/pdf/WildlifeFriendlyErosionControlProducts_revised.pdf for further information. There also may be State, Tribal, or local requirements about using wildlife friendly erosion control products.

³⁷ EPA may determine, based on an inspection carried out under Part 4.8 and corrective actions required under Part 5.3, that the level of sediment discharge on the site makes it necessary to require a faster schedule for completing stabilization. For instance, if sediment discharges from an area of exposed soil that is required to be stabilized are compromising the performance of existing stormwater controls, EPA may require stabilization to correct this problem.

³⁸ Limiting disturbances to five (5) acres or less at any one time means that at no time during the project do the cumulative earth disturbances exceed five (5) acres. The following examples would qualify as limiting disturbances at any one time to five (5) acres or less:

1. The total area of disturbance for a project is five (5) acres or less.
2. The total area of disturbance for a project will exceed five (5) acres, but the operator ensures that no more than five (5) acres will be disturbed at any one time through implementation of stabilization measures. In this way, site stabilization can be used to “free up” land that can be disturbed without exceeding the five (5)-acre cap to qualify for the 14-day stabilization deadline. For instance, if an operator completes stabilization of two (2) acres of land on a five (5)-acre disturbance, then two (2) additional acres could be disturbed while still qualifying for the longer 14-day stabilization deadline.

³⁹ The following are examples of activities that would constitute the immediate initiation of stabilization:

1. Prepping the soil for vegetative or non-vegetative stabilization as long as seeding, planting, and/or installation of non-vegetative stabilization products takes place as soon as practicable, but no later than one (1) calendar day of completing soil preparation;
2. Applying mulch or other non-vegetative product to the exposed area;
3. Seeding or planting the exposed area;
4. Starting any of the activities in # 1 – 3 on a portion of the entire area that will be stabilized; and
5. Finalizing arrangements to have stabilization product fully installed in compliance with the deadlines for completing stabilization.

⁴⁰ The requirement to initiate stabilization immediately is triggered as soon as you know that construction work on a portion of the site is temporarily ceased and will not resume for 14 or more days, or as soon as you know that construction work is permanently ceased. In the context of this provision, “immediately” means as soon as practicable, but no later than the end of the next business day, following the day when the construction activities have temporarily or permanently ceased.

Total Amount of Land Disturbance Occurring At Any One Time ³⁸	Deadline
	after stabilization has been initiated. ⁴¹
ii. More than five acres (>5.0)	<ul style="list-style-type: none"> • Initiate the installation of stabilization measures immediately⁴² in any areas of exposed soil where construction activities have permanently ceased or will be temporarily inactive for 14 or more calendar days;⁴³ and • Complete the installation of stabilization measures as soon as practicable, but no later than seven (7) calendar days after stabilization has been initiated.⁴⁴

b. Exceptions:

- i. Arid, semi-arid, and drought-stricken areas** (as defined in Appendix A). If it is the seasonally dry period (as defined in Appendix A)⁴⁵ or a period in which drought is occurring, and vegetative stabilization measures are being used:

- (a) Immediately initiate and, within 14 calendar days of temporary or permanent cessation of work in any portion of your site, complete the installation of temporary non-vegetative stabilization measures to the extent necessary to prevent erosion;
- (b) As soon as practicable, given conditions or circumstances on the site, complete all activities necessary to seed or plant the area to be stabilized; and
- (c) If construction is occurring during the seasonally dry period, indicate in your SWPPP the beginning and ending dates of the seasonally dry period and your site conditions. Also include the schedule you will follow for initiating and completing vegetative stabilization.

- ii. Unforeseen circumstances.** Operators that are affected by unforeseen circumstances⁴⁶ that delay the initiation and/or completion of vegetative stabilization:

⁴¹ If vegetative stabilization measures are being implemented, stabilization is considered "installed" when all activities necessary to seed or plant the area are completed, including the application of any non-vegetative protective cover (e.g., mulch, erosion control blanket), if applicable. If non-vegetative stabilization measures are being implemented, stabilization is considered "installed" when all such measures are implemented or applied.

⁴² See footnote 39.

⁴³ See footnote 40.

⁴⁴ See footnote 41.

⁴⁵ The term "seasonally dry period" as defined in Appendix A refers to a month in which the long-term average total precipitation is less than or equal to 0.5 inches. Refer to EPA's Seasonally Dry Period Locator Tool at <https://www.epa.gov/npdes/construction-general-permit-resources-tools-and-templates> and supporting maps for assistance in determining whether a site is operating during a seasonally dry period for the area.

⁴⁶ Examples include problems with the supply of seed stock or with the availability of specialized equipment and unsuitability of soil conditions due to excessive precipitation and/or flooding.

- (a) Immediately initiate and, within 14 calendar days, complete the installation of temporary non-vegetative stabilization measures to prevent erosion;
 - (b) Complete all soil conditioning, seeding, watering or irrigation installation, mulching, and other required activities related to the planting and initial establishment of vegetation as soon as conditions or circumstances allow it on your site; and
 - (c) Document in the SWPPP the circumstances that prevent you from meeting the deadlines in Part 2.2.14a and the schedule you will follow for initiating and completing stabilization.
- iii. Discharges to a sediment- or nutrient-impaired water or to a water that is identified by your State, Tribe, or EPA as Tier 2, Tier 2.5, or Tier 3 for antidegradation purposes.** Complete stabilization as soon as practicable, but no later than seven (7) calendar days after stabilization has been initiated.
- iv. Discharges to a receiving water located within Lands of Exclusive Federal Jurisdiction.** Complete stabilization as soon as practicable, but no later than seven (7) calendar days after stabilization has been initiated. This deadline applies regardless of whether another exception in this section applies to your site.
- c. Final Stabilization Criteria** (for any areas not covered by permanent structures):
- i.** Establish uniform, perennial vegetation (*i.e., evenly distributed, without large bare areas*) to provide 70 percent or more of the vegetative cover native to local undisturbed areas; and/or
 - ii.** Implement permanent non-vegetative stabilization measures⁴⁷ to provide effective cover of any areas of exposed soil.
 - iii. Exceptions:**
 - (a) **Arid, semi-arid, and drought-stricken areas** (as defined in Appendix A). Final stabilization is met if the area has been seeded or planted to establish vegetation that provides 70 percent or more of the vegetative cover native to local undisturbed areas within three (3) years and, to the extent necessary to prevent erosion on the seeded or planted area, non-vegetative erosion controls have been applied to provide cover for at least three years without active maintenance.
 - (b) **Disturbed areas on agricultural land that are restored to their preconstruction agricultural use.** The Part 2.2.14c final stabilization criteria do not apply.
 - (c) **Areas that need to remain disturbed.** In limited circumstances, stabilization may not be required if the intended function of a specific area of the site necessitates that it remain disturbed, and only the minimum area needed remains disturbed (*e.g., dirt access roads, utility pole pads, areas being used for storage of vehicles, equipment, materials*).

⁴⁷ Examples of permanent non-vegetative stabilization measures include riprap, gravel, gabions, and geotextiles.

2.3 POLLUTION PREVENTION REQUIREMENTS⁴⁸

You must implement pollution prevention controls in accordance with the following requirements to minimize the discharge of pollutants in stormwater and to prevent the discharge of pollutants from spilled or leaked materials from construction activities.

2.3.1 For equipment and vehicle fueling and maintenance:

- a. Provide an effective means of eliminating the discharge of spilled or leaked chemicals, including fuels and oils, from these activities;⁴⁹
- b. If applicable, comply with the Spill Prevention Control and Countermeasures (SPCC) requirements in 40 CFR part 112 and Section 311 of the CWA;
- c. Ensure adequate supplies are available at all times to handle spills, leaks, and disposal of used liquids;
- d. Use drip pans and absorbents under or around leaky vehicles;
- e. Dispose of or recycle oil and oily wastes in accordance with other Federal, State, Tribal, or local requirements; and
- f. Clean up spills or contaminated surfaces immediately, using dry clean up measures (do not clean contaminated surfaces by hosing the area down), and eliminate the source of the spill to prevent a discharge or a continuation of an ongoing discharge.

2.3.2 For equipment and vehicle washing:

- a. Provide an effective means of minimizing the discharge of pollutants from equipment and vehicle washing, wheel wash water, and other types of wash waters;⁵⁰
- b. Ensure there is no discharge of soaps, solvents, or detergents in equipment and vehicle wash water; and
- c. For storage of soaps, detergents, or solvents, provide either (1) cover (e.g., *plastic sheeting, temporary roofs*) to minimize the exposure of these detergents to precipitation and to stormwater, or (2) a similarly effective means designed to minimize the discharge of pollutants from these areas.

⁴⁸ Under this permit, you are not required to minimize exposure for any products or materials where the exposure to precipitation and to stormwater will not result in a discharge of pollutants, or where exposure of a specific material or product poses little risk of stormwater contamination (such as final products and materials intended for outdoor use).

⁴⁹ Examples of effective means include:

- Locating activities away from receiving waters, storm drain inlets, and constructed or natural site drainage feature so that stormwater coming into contact with these activities cannot reach waters of the U.S.;
- Providing secondary containment (e.g., *spill berms, dikes, spill containment pallets*) and cover where appropriate; and
- Having a spill kit available on site and ensuring personnel are available to respond expeditiously in the event of a leak or spill.

⁵⁰ Examples of effective means include locating activities away from receiving waters and storm drain inlets or constructed or natural site drainage features and directing wash waters to a sediment basin or sediment trap, using filtration devices, such as filter bags or sand filters, or using other similarly effective controls.

2.3.3 For storage, handling, and disposal of building products, materials, and wastes:⁵¹

- a.** For building materials and building products,⁵² provide either (1) cover (e.g., plastic sheeting, temporary roofs) to minimize the exposure of these products to precipitation and to stormwater, or (2) a similarly effective means designed to minimize the discharge of pollutants from these areas.

Exception: Minimization of exposure is not required in cases where the exposure to precipitation and to stormwater will not result in a discharge of pollutants, or where exposure of a specific material or product poses little risk of stormwater contamination (such as final products and materials intended for outdoor use).

- b.** For pesticides, herbicides, insecticides, fertilizers, and landscape materials:
- i.** In storage areas, provide either (1) cover (e.g., plastic sheeting, temporary roofs) to minimize the exposure of these chemicals to precipitation and to stormwater, or (2) a similarly effective means designed to minimize the discharge of pollutants from these areas; and
 - ii.** Comply with all application and disposal requirements included on the registered pesticide, herbicide, insecticide, and fertilizer label (see also Part 2.3.5).
- c.** For diesel fuel, oil, hydraulic fluids, other petroleum products, and other chemicals: The following requirements apply to the storage and handling of chemicals on your site. If you are already implementing controls as part of an SPCC or other spill prevention plan that meet or exceed the requirements of this Part, you may continue to do so and be considered in compliance with these provisions provided you reference the applicable parts of the SPCC or other plans in your SWPPP as required in Part 7.2.6b.viii.
- i.** If any chemical container has a storage capacity of less than 55 gallons:
 - (a) The containers must be water-tight, and must be kept closed, sealed, and secured when not being actively used;
 - (b) If stored outside, use a spill containment pallet or similar device to capture small leaks or spills; and
 - (c) Have a spill kit available on site that is in good working condition (i.e., not damaged, expired, or used up) and ensure personnel are available to respond immediately in the event of a leak or spill.
 - ii.** If any chemical container has a storage capacity of 55 gallons or more:
 - (a) The containers must be water-tight, and must be kept closed, sealed, and secured when not being actively used;
 - (b) Store containers a minimum of 50 feet from receiving waters, constructed or natural site drainage features, and storm drain inlets. If infeasible due to site constraints, store containers as far away from these features as the site

⁵¹ Compliance with the requirements of this permit does not relieve compliance requirements with respect to Federal, State, or local laws and regulations governing the storage, handling, and disposal of solid, hazardous, or toxic wastes and materials.

⁵² Examples of building materials and building products typically present at construction sites include asphalt sealants, copper flashing, roofing materials, adhesives, concrete admixtures, and gravel and mulch stockpiles.

permits. If site constraints prevent you from storing containers 50 feet away from receiving waters or the other features identified, you must document in your SWPPP the specific reasons why the 50-foot setback is infeasible, and how you will store containers as far away as the site permits;

- (c) Provide either (1) cover (e.g., temporary roofs) to minimize the exposure of these containers to precipitation and to stormwater, or (2) secondary containment (e.g., curbing, spill berms, dikes, spill containment pallets, double-wall, above-ground storage tank); and
 - (d) Have a spill kit available on site that is in good working condition (i.e., not damaged, expired, or used up) and ensure personnel are available to respond immediately in the event of a leak or spill. Additional secondary containment measures are listed at 40 CFR § 112.7(c)(1).
- iii. Clean up spills immediately, using dry clean-up methods where possible, and dispose of used materials properly. You are prohibited from hosing the area down to clean surfaces or spills. Eliminate the source of the spill to prevent a discharge or a furtherance of an ongoing discharge.
- d.** *For hazardous or toxic wastes:*⁵³
- i. Separate hazardous or toxic waste from construction and domestic waste;
 - ii. Store waste in sealed containers, constructed of suitable materials to prevent leakage and corrosion, and labeled in accordance with applicable Resource Conservation and Recovery Act (RCRA) requirements and all other applicable Federal, State, Tribal, or local requirements;
 - iii. Store all outside containers within appropriately-sized secondary containment (e.g., *spill berms, dikes, spill containment pallets*) to prevent spills from being discharged, or provide a similarly effective means designed to prevent the discharge of pollutants from these areas (e.g., *storing chemicals in a covered area, having a spill kit available on site*);
 - iv. Dispose of hazardous or toxic waste in accordance with the manufacturer's recommended method of disposal and in compliance with Federal, State, Tribal, and local requirements;
 - v. Clean up spills immediately, using dry clean-up methods, and dispose of used materials properly. You are prohibited from hosing the area down to clean surfaces or spills. Eliminate the source of the spill to prevent a discharge or a furtherance of an ongoing discharge; and
 - vi. Follow all other Federal, State, Tribal, and local requirements regarding hazardous or toxic waste.
- e.** *For construction and domestic wastes:*⁵⁴

⁵³ Examples of hazardous or toxic waste that may be present at construction sites include paints, caulks, sealants, fluorescent light ballasts, solvents, petroleum-based products, wood preservatives, additives, curing compounds, and acids.

⁵⁴ Examples of construction and domestic wastes include packaging materials, scrap construction materials, masonry products, timber, pipe and electrical cuttings, plastics, styrofoam, concrete, demolition debris; and other trash or discarded materials.

2.3.5 For the application of fertilizers:

- a. Apply at a rate and in amounts consistent with manufacturer's specifications, or document in the SWPPP departures from the manufacturer specifications where appropriate in accordance with Part 7.2.6b.x;
- b. Apply at the appropriate time of year for your location, and preferably timed to coincide as closely as possible to the period of maximum vegetation uptake and growth;
- c. Avoid applying before heavy rains that could cause excess nutrients to be discharged;
- d. Never apply to frozen ground;
- e. Never apply to constructed or natural site drainage features; and
- f. Follow all other Federal, State, Tribal, and local requirements regarding fertilizer application.

2.3.6 Emergency Spill Notification Requirements

Discharges of toxic or hazardous substances from a spill or other release are prohibited, consistent with Part 1.3.5. Where a leak, spill, or other release containing a hazardous substance or oil in an amount equal to or in excess of a reportable quantity established under either 40 CFR part 110, 40 CFR part 117, or 40 CFR part 302 occurs during a 24-hour period, you must notify the National Response Center (NRC) at (800) 424-8802 or, in the Washington, DC metropolitan area, call (202) 267-2675 in accordance with the requirements of 40 CFR part 110, 40 CFR part 117, and 40 CFR part 302 as soon as you have knowledge of the release. You must also, within seven (7) calendar days of knowledge of the release, provide a description of the release, the circumstances leading to the release, and the date of the release. State, Tribal, or local requirements may necessitate additional reporting of spills or discharges to local emergency response, public health, or drinking water supply agencies.

2.4 CONSTRUCTION DEWATERING REQUIREMENTS

Comply with the following requirements to minimize the discharge of pollutants from dewatering⁵⁵ operations.

- 2.4.1** Route dewatering water through a sediment control (e.g., sediment trap or basin, pumped water filter bag) designed to prevent discharges with visual turbidity;⁵⁶
- 2.4.2** Do not discharge visible floating solids or foam;
- 2.4.3** The discharge must not cause the formation of a visible sheen on the water surface, or visible oily deposits on the bottom or shoreline of the receiving water. Use an oil-water separator or suitable filtration device (such as a cartridge filter) designed to remove oil, grease, or other products if dewatering water is found to or expected to contain these materials;

⁵⁵ "Dewatering" is defined in Appendix A as "the act of draining accumulated stormwater and/or ground water from building foundations, vaults, and trenches, or other similar points of accumulation."

⁵⁶ For the purposes of this permit, visual turbidity is present where there is a sediment plume in the discharge or the discharge appears cloudy, or opaque, or has a visible contrast that can be identified by an observer.

- 2.4.4** To the extent feasible, use well-vegetated (e.g., grassy or wooded), upland areas of the site to infiltrate dewatering water before discharge.⁵⁷ You are prohibited from using receiving waters as part of the treatment area;
- 2.4.5** To prevent dewatering-related erosion and related sediment discharges:
- a.** Use stable, erosion-resistant surfaces (e.g., well-vegetated grassy areas, clean filter stone, geotextile underlayment) to discharge from dewatering controls;
 - b.** Do not place dewatering controls, such as pumped water filter bags, on steep slopes (as defined in Appendix A); and
 - c.** At all points where dewatering water is discharged, comply with the velocity dissipation requirements of Part 2.2.11.
- 2.4.6** For backwash water, either haul it away for disposal or return it to the beginning of the treatment process;
- 2.4.7** Replace and clean the filter media used in dewatering devices when the pressure differential equals or exceeds the manufacturer's specifications; and
- 2.4.8** Comply with dewatering-specific inspection requirements in Part 4.

3 WATER QUALITY-BASED EFFLUENT LIMITATIONS

3.1 GENERAL EFFLUENT LIMITATION TO MEET APPLICABLE WATER QUALITY STANDARDS

Discharges must be controlled as necessary to meet applicable water quality standards. Discharges must also comply with any additional State or Tribal requirements that are in Part 9.

In the absence of information demonstrating otherwise, EPA expects that compliance with the conditions in this permit will result in stormwater discharges being controlled as necessary to meet applicable water quality standards. If at any time you become aware, or EPA determines, that discharges are not being controlled as necessary to meet applicable water quality standards, you must take corrective action as required in Parts 5.1 and 5.2, and document the corrective actions as required in Part 5.4.

EPA may insist that you install additional controls (to meet the narrative water quality-based effluent limit above) on a site-specific basis, or require you to obtain coverage under an individual permit, if information in your NOI or from other sources indicates that your discharges are not controlled as necessary to meet applicable water quality standards. This includes situations where additional controls are necessary to comply with a wasteload allocation in an EPA-established or approved TMDL.

If during your coverage under a previous permit, you were required to install and maintain stormwater controls specifically to meet the assumptions and requirements of an EPA-approved or established TMDL (for any parameter) or to otherwise control your discharge to meet water quality standards, you must continue to implement such controls as part of your coverage under this permit.

3.2 WATER QUALITY-BASED CONDITIONS FOR SITES DISCHARGING TO CERTAIN IMPAIRED AND HIGH QUALITY RECEIVING WATERS

For any portion of the site that discharges to a sediment or nutrient-impaired water or to a water that is identified by your State, Tribe, or EPA as Tier 2, Tier 2.5, or Tier 3 for

⁵⁷ See footnote 20.

antidegradation purposes,⁵⁸ you must comply with the inspection frequency specified in Part 4.3 and you must comply with the stabilization deadline specified in Part 2.2.14b.iii.⁵⁹

If you discharge to a water that is impaired for a parameter other than a sediment-related parameter or nutrients, EPA will inform you if any additional controls are necessary for your discharge to be controlled as necessary to meet water quality standards. These controls might include those necessary for your discharge to be consistent with the assumptions of any available wasteload allocation in any applicable TMDL. In addition, EPA may require you to apply for and obtain coverage under an individual NPDES permit.

In addition, on a case-by-case basis, EPA may notify operators of new sites or operators of existing sites with increased discharges that additional analyses, stormwater controls, and/or other measures are necessary to comply with the applicable antidegradation requirements, or notify you that an individual permit application is necessary.

If you discharge to a water that is impaired for polychlorinated biphenyls (PCBs) and are engaging in demolition of any structure with at least 10,000 square feet of floor space built or renovated before January 1, 1980, you must:

- a. Implement controls⁶⁰ to minimize the exposure of PCB-containing building materials, including paint, caulk, and pre-1980 fluorescent lighting fixtures, to precipitation and to stormwater; and
- b. Ensure that disposal of such materials is performed in compliance with applicable State, Federal, and local laws.

3.3 TURBIDITY BENCHMARK MONITORING FOR SITES DISCHARGING DEWATERING WATER TO PROTECT THE WATER QUALITY OF SENSITIVE WATERS

For sites discharging dewatering water to "sensitive waters" (i.e., receiving waters listed as impaired for sediment or a sediment-related parameter (as defined in Appendix A), receiving waters designated as a Tier 2, Tier 2.5, or Tier 3 for antidegradation purposes, or receiving waters located within Lands of Exclusive Federal Jurisdiction) you are required to comply with the benchmark monitoring requirements in this Part and document the procedures you will use at your site in your SWPPP pursuant to Part 7.2.8. A summary of these requirements is included in Table 1.

EPA notes that the benchmark threshold is not an effluent limitation, rather it is an indicator that the dewatering controls may not be working to protect water quality, which the operator must investigate and correct as appropriate. A benchmark exceedance is not a permit violation. However, if a benchmark exceedance triggers

⁵⁸ Refer to Appendix A for definitions of "impaired water" and "Tier 2," "Tier 2.5," and "Tier 3" waters. For assistance in determining whether your site discharges to impaired waters, EPA has developed a tool that is available at <https://www.epa.gov/npdes/epas-stormwater-discharge-mapping-tools>. For assistance in determining whether your site discharges to a Tier 2, 2.5, or 3 water, refer to the list of such waters at <https://www.epa.gov/npdes/construction-general-permit-resources-tools-and-templates>.

⁵⁹ If you qualify for any of the reduced inspection frequencies in Part 4.4, you may conduct inspections in accordance with Part 4.4 for any portion of your site that discharges to a sensitive water.

⁶⁰ Examples of controls to minimize exposure of PCBs to precipitation and stormwater include separating work areas from non-work areas and selecting appropriate personal protective equipment and tools, constructing a containment area so that all dust or debris generated by the work remains within the protected area, and using tools that minimize dust and heat (<212°F). For additional information, refer to Part 2.3.3 of the CGP Fact Sheet.

corrective action in Part 5.1.5a, failure to conduct any required action is a permit violation.

Where there are multiple operators associated with the same site, the operators may coordinate with one another to carry out the monitoring requirements of this Part in order to avoid duplicating efforts. Such coordinating arrangements must be described in the SWPPP consistent with Part 7.2.8. Regardless of how the operators divide the responsibilities for monitoring and reporting, each operator remains responsible for compliance with these requirements.⁶¹

3.3.1 Turbidity monitoring requirements⁶²

- a. Sampling frequency.** You must collect at least one turbidity sample from your dewatering discharge each day a discharge occurs.
- b. Sampling location.** Samples must be taken at all points where dewatering water is discharged. Samples must be taken after the dewatering water has been treated by installed treatment devices pursuant to Parts 2.4.1 and 2.4.3 and prior to its discharge off site into a receiving water, constructed or natural site drainage feature, or storm drain inlet.
- c. Representative samples.** Samples taken must be representative of the dewatering discharge for any given day as required in Appendix G (standard permit conditions), Part G.10.2.
- d. Test methods.** Samples must be measured using a turbidity meter that reports results in nephelometric turbidity units (NTUs) and conforms with a Part 136-approved method (e.g., methods 180.1 and 2130). You are required to use the meter, and conduct a calibration verification prior to each day's use, consistent with the manufacturer's instructions.

3.3.2 Turbidity benchmark

- a.** The benchmark threshold for turbidity for this permit is 50 NTUs (referred to elsewhere in this permit as the "standard 50 NTU benchmark") unless EPA has authorized the use of an alternate benchmark in accordance with Part 3.3.2b.
- b. Request for alternate benchmark threshold.**
 - i.** At any time prior to or during your coverage under this permit, you may request that EPA approve a benchmark for your site that is higher than 50 NTUs if you

⁶¹ For instance, if Operator A relies on Operator B to meet the Part 3.3.1 turbidity monitoring requirements, the Part 3.3.4 reporting and recordkeeping requirements, and the Part 5.2.2 corrective action provisions when applicable, Operator A does not have to duplicate these same functions if Operator B is implementing them for both operators to be in compliance with the permit. However, Operator A remains responsible for complying with these permit requirements if Operator B fails to take actions that were necessary for Operator A to comply with the permit. See also footnote 84. EPA notes that both Operator A and B are required to submit turbidity monitoring reports as required under Part 3.3.4, however, Operator A's report does not need to include the data collected by Operator B as long as Operator B submits the required data and Operator A's report indicates that it is relying on Operator B to report the data. See Part 3.3.4a.

⁶² Operators may find it useful to consult EPA's *Monitoring and Inspection Guide for Construction Dewatering*, available at <https://www.epa.gov/npdcs/construction-general-permit-resources-tools-and-templates>, which provides guidelines on how to correctly monitor for turbidity, determine if the weekly average exceeds the benchmark, and, if so, how to proceed with corrective action.

have information demonstrating the higher number is the same as your receiving water's water quality standard for turbidity. Unless EPA approves an alternate benchmark, you will be required to use the standard 50 NTU benchmark. To request approval of an alternate benchmark, you must submit the following information to your applicable EPA Regional Office (see Appendix K):

- (a) The current turbidity water quality standard that applies to your receiving water and the source/citation.⁶³
 - (b) If the applicable turbidity water quality standard requires information on natural or background turbidity levels (e.g., "no more than 10 NTU above natural turbidity levels") to determine the specific standard for the receiving water, include available data that can be used to establish the natural turbidity levels of your receiving water (including literature studies or Federal, State, Tribal, or local government data). Data must be representative of the natural turbidity levels of your specific receiving water. Identify the source(s) of all data provided, including if the data are from samples you collected of the receiving water.
- ii. EPA will inform you of its decision on whether to approve the requested alternate benchmark within 30 days. EPA may approve your request, request additional time (e.g., if additional information is needed to substantiate the data you provided), or deny your request. Unless and until EPA approves your request to use an alternate benchmark, you are required to use the standard benchmark of 50 NTUs and take any required corrective actions if an exceedance occurs.

3.3.3 Comparison of turbidity samples to benchmark. Compare the weekly average⁶⁴ of your turbidity monitoring results to the standard 50 NTU benchmark, or alternate benchmark if approved by EPA.

- a. If the weekly average of your turbidity monitoring results exceeds the standard benchmark (or your approved alternate benchmark), you are required to conduct follow-up corrective action in accordance with Part 5.2.2 and document any corrective action taken in your corrective action log in accordance with Part 5.4.
- b. For averaging purposes, a "monitoring week" starts with a Monday and ends on Sunday. Once a new monitoring week starts, you will need to calculate a new average for that week of turbidity monitoring results.⁶⁵ A weekly average may consist

⁶³ For instance, if your site is located in Washington, DC, and you are discharging to a Class B water, for which the water quality standard is that turbidity may not increase above ambient levels by more than 20 percent, you would reference "Water Quality Standards for the District of Columbia, Chapter 11, Section 1104.8."

⁶⁴ A "weekly average" is defined as the sum of all of the turbidity samples taken during a "monitoring week" divided by the number of samples measured during that week. Average values should be calculated to the nearest whole number.

⁶⁵ For example, if turbidity samples from your dewatering discharge in week 1 result in values of 30 NTU on Tuesday, 40 NTU on Wednesday, and 45 NTU on Thursday, your weekly average turbidity value would be 38.33 NTU $((30+40+45) \div 3 = 38 \text{ NTU})$. If in week 2, your turbidity samples resulted in values of 45 NTU on Monday, 30 NTU on Tuesday, 25 NTU on Wednesday, and 15 NTU on Thursday, you would calculate a new average for that week, which would yield an average turbidity value of 28.75 NTU $((45+30+25+15) \div 4 = 29 \text{ NTU})$. By comparison, if your samples on consecutive days from Friday to Monday were 60 NTU, 45 NTU, 40

of one or more turbidity monitoring results.

- c. Although you are not required to collect and analyze more than one turbidity sample per day from your dewatering discharge, if you do collect and analyze more than one sample on any given day, you must include any additional results in the calculation of your weekly average (i.e., add all individual results for that monitoring week and divide by the total number of samples).⁶⁶
- d. If you are conducting turbidity monitoring for more than one dewatering discharge point, you must calculate a weekly average turbidity value for each discharge point and compare each to the turbidity benchmark.

3.3.4 Reporting and recordkeeping.

- a. You must submit reports of your weekly average turbidity data to EPA no later than 30 days following the end of each monitoring quarter. If there are monitoring weeks in which there was no dewatering discharge, or if there is a monitoring quarter with no dewatering discharge, indicate this in your turbidity monitoring report. If another operator associated with your same site is conducting turbidity monitoring on your behalf pursuant to Part 3.3, indicate this in your turbidity monitoring report.
- b. For the purposes of this permit, the following monitoring quarters and reporting deadlines apply:

Table 3. Monitoring Quarters and Deadlines for Reporting Turbidity Benchmark Monitoring Data.

Monitoring Quarter #	Months	Reporting Deadline (no later than 30 days after end of the monitoring quarter)
1	January 1 – March 31	April 30
2	April 1 – June 30	July 30
3	July 1 – September 30	October 30
4	October 1 – December 31	January 30

- c. You must use EPA's NPDES eReporting Tool (NeT) to electronically submit your quarterly turbidity data, unless, consistent with Part 1.4.2, you received a waiver from your applicable EPA Regional Office. If the EPA Regional Office grants you approval to use a paper turbidity monitoring report form, and you elect to use it, you must complete the form in Appendix K. If EPA approves of your request to use an alternate turbidity benchmark pursuant to Part 3.3.2b, EPA will substitute the alternate benchmark in your NeT account.
- d. For each day in which you are required to monitor, you must record the monitoring information required by Appendix G, Parts G.10.2 and G.10.3 and retain all such information for a period of at least three years from the date this permit expires or

NTU, and 43 NTU, respectively, and there are no other dewatering discharges for the remainder of the week, you would calculate one weekly average for the Friday to Sunday to be 48 NTU $((60+45+40) \div 3 = 48$ NTU), and a separate weekly average for the one Monday to be 43 NTU $(43 \div 1 = 43$ NTU).

⁶⁶ For example, if during a monitoring week you take two turbidity samples on Tuesday with a value of 30 NTU and 35 NTU, three samples on Wednesday with a value of 40 NTU, 45 NTU, and 48 NTU, and one sample on Thursday with a value of 45 NTU, your weekly average turbidity value for this week would be 41 NTU $((30+35+40+45+48+45) \div 6 = 41$ NTU).

from the date your authorization is terminated.

Table 4. Summary of Turbidity Benchmark Monitoring Requirements.

Applicability	Sampling Requirement	Turbidity Benchmark	Corrective Action	Reporting
Sites discharging dewatering water to a sediment-impaired water, to a water designated as a Tier 2, Tier 2.5, or Tier 3 for antidegradation purposes, or to receiving waters located within Lands of Exclusive Federal Jurisdiction.	Collect at least one turbidity sample per day, from each discharge point, on any day there is a dewatering discharge. Use turbidity sampling procedures specified in Part 3.3.1.	Compare the weekly average of your turbidity monitoring results to the 50 NTU benchmark (or alternate benchmark if approved by EPA).	If the weekly average of turbidity monitoring results exceeds the 50 NTU turbidity benchmark (or alternate benchmark if approved by EPA), you are required to take follow-up corrective action in accordance with Part 5.2.2.	Report all weekly average turbidity monitoring results on a quarterly basis via NeT-CGP (unless use of the paper monitoring form in Appendix K is approved by EPA) no later than 30 days following the end of each monitoring quarter.

4 INSPECTION REQUIREMENTS

4.1 PERSON(S) RESPONSIBLE FOR CONDUCTING SITE AND DEWATERING INSPECTIONS

The person(s) inspecting your site may be a person on your staff or a third party you hire to conduct such inspections. You are responsible for ensuring that any person conducting inspections pursuant to this Part is a “qualified person.” A qualified person is someone who has completed the training required by Part 6.3.

4.2 FREQUENCY OF INSPECTIONS.⁶⁷

At a minimum, you must conduct a site inspection in accordance with one of the two schedules listed below, unless you are subject to the Part 4.3 site inspection frequency for discharges to sediment or nutrient-impaired or high quality waters, or qualify for a Part 4.4 reduction in the inspection frequency:

4.2.1 At least once every seven (7) calendar days; or

4.2.2 Once every 14 calendar days and within 24 hours⁶⁸ of the occurrence of:

- a.** A storm event that produces 0.25 inches or more of rain within a 24-hour period.
 - i.** If a storm event produces 0.25 inches or more of rain within a 24-hour period (including when there are multiple, smaller storms that alone produce less than

⁶⁷ Inspections are only required during the site’s normal working hours.

⁶⁸ For the purposes of the inspection requirements in this Part, conducting an inspection “within 24 hours” means that once either of the two conditions in Parts 4.2.2a or 4.2.2b are met you have 24 hours from that time to conduct an inspection. For clarification, the 24 hours is counted as a continuous passage of time, and not counted by business hours (e.g., 3 business days of 8 hours each). When the 24-hour inspection time frame occurs entirely outside of normal working hours, you must conduct an inspection by no later than the end of the next business day.

0.25 inches but together produce 0.25 inches or more in 24 hours), you are required to conduct one inspection within 24 hours of when 0.25 inches of rain or more has fallen.

- ii. If a storm event produces 0.25 inches or more of rain within a 24-hour period on the first day of a storm and continues to produce 0.25 inches or more of rain on subsequent days, you must conduct an inspection within 24 hours of the first day of the storm and within 24 hours after the last day of the storm that produces 0.25 inches or more of rain (i.e., only two inspections would be required for such a storm event).⁶⁹
 - b. A discharge caused by snowmelt from a storm event that produces 3.25 inches⁷⁰ or more of snow within a 24-hour period. You are required to conduct one inspection once the discharge of snowmelt from a 3.25-inch or more snow accumulation occurs. Additional snowmelt inspections are only required if following the discharge from the first snowmelt, there is a discharge from a separate storm event that produces 3.25 inches or more of snow.
- 4.2.3** To determine whether a storm event meets either of the thresholds in Parts 4.2.2a or 4.2.2b:
- a. For rain, you must either keep a properly maintained rain gauge on your site, or obtain the storm event information from a weather station that is representative of your location. For any 24-hour period during which there is 0.25 inches or more of rainfall, you must record the total rainfall measured for that day in accordance with Part 4.7.1d.
 - b. For snow, you must either take measurements of snowfall at your site,⁷¹ or rely on similar information from a local weather forecasting provider that is representative of your location.

4.3 INCREASE IN INSPECTION FREQUENCY FOR CERTAIN SITES.

The increased inspection frequencies established in this Part take the place of the Part 4.2 inspection frequencies for the portion of the site affected.

- 4.3.1 For any portion of the site that discharges to a sediment or nutrient-impaired water or to a water that is identified by your State, Tribe, or EPA as Tier 2, Tier 2.5, or Tier 3 for antidegradation purposes (see Part 3.2), or that discharges to receiving waters located within Lands of Exclusive Federal Jurisdiction, you must conduct an inspection once every seven (7) calendar days and within 24 hours of the occurrence of a storm event**

⁶⁹ For example, if 0.30 inches of rain falls on Day 1, 0.25 inches of rain falls on Day 2, and 0.10 inches of rain fall on Day 3, you would be required to conduct a first inspection within 24 hours of the Day 1 rainfall and a second inspection within 24 hours of the Day 2 rainfall, but a third inspection would not be required within 24 hours of the Day 3 rainfall.

⁷⁰ This is the amount of snow that is equivalent to 0.25 inches of rain, based on information from the National Oceanic and Atmospheric Administration (NOAA) indicating that 13 inches of snow is, on average, equivalent to 1 inch of rain. See <https://www.nssl.noaa.gov/education/svrwx101/winter/faq/>.

⁷¹ For snowfall measurements, EPA suggests use of NOAA's National Weather Service guidelines at https://www.weather.gov/jkl/snow_measurement. These guidelines recommend use of a "snowboard" (a piece of wood about 16 inches by 16 inches) that is placed in an unobstructed part of the site on a hard surface.

that produces 0.25 inches or more of rain within a 24-hour period, or within 24 hours of a snowmelt discharge from a storm event that produces 3.25 inches or more of snow within a 24-hour period.

Refer to Parts 4.2.3a and 4.2.3b for the requirements to determine if a storm event produces enough rain or snow to trigger the inspection requirement.

4.3.2 For sites discharging dewatering water, you must conduct an inspection in accordance with Part 4.6.3 during the discharge once per day on which the discharge occurs. The Part 4.2 inspection frequency still applies to all other portions of the site, unless the site is affected by either the increased frequency in Part 4.3.1 or the reduced frequency in Part 4.4.

4.4 REDUCTIONS IN INSPECTION FREQUENCY

4.4.1 Stabilized areas.

- a.** You may reduce the frequency of inspections to twice per month for the first month, no more than 14 calendar days apart, then once per month until permit coverage is terminated consistent with Part 8 in any area of your site where the stabilization steps in Part 2.2.14a have been completed. If construction activity resumes in this portion of the site at a later date, the inspection frequency immediately increases to that required in Parts 4.2 and 4.3, as applicable. You must document the beginning and ending dates of this period in your SWPPP.
- b. Exception.** For "linear construction sites" (as defined in Appendix A) where disturbed portions have undergone final stabilization at the same time active construction continues on others, you may reduce the frequency of inspections to twice per month for the first month, no more than 14 calendar days apart, in any area of your site where the stabilization steps in Part 2.2.14a have been completed. After the first month, inspect once more within 24 hours of the occurrence of a storm event that produces 0.25 inches of rain or more within a 24-hour period, or within 24 hours of a snowmelt discharge from a storm event that produces 3.25 inches or more of snow within a 24-hour period. If there are no issues or evidence of stabilization problems, you may suspend further inspections. If "wash-out" of stabilization materials and/or sediment is observed, following re-stabilization, inspections must resume at the inspection frequency required in Part 4.4.1a. Inspections must continue until final stabilization is visually confirmed following a storm event that produces 0.25 inches of rain or more within a 24-hour period.

4.4.2 Arid, semi-arid, or drought-stricken areas (as defined in Appendix A). If it is the seasonally dry period⁷² or a period in which drought is occurring, you may reduce the frequency of inspections to once per month and within 24 hours of the occurrence of a storm event that produces 0.25 inches of rain or more within a 24-hour period, or within 24 hours of a snowmelt discharge from a storm event that produces 3.25 inches or more of snow within a 24-hour period. You must document that you are using this reduced schedule and the beginning and ending dates of the seasonally dry period in your SWPPP. Follow the procedures in Part 4.2.3a and 4.2.3b, accordingly, to determine if a storm event occurs that produces 0.25 inches or more of rain or 3.25 inches or more of snow within a 24-hour period. For any 24-hour period during which there is 0.25 inches or more of rainfall, or 3.25

⁷² See footnote 45.

inches or more of snow, you must record the total rainfall or snow measured for that day in accordance with Part 4.7.1d.

4.4.3 Frozen conditions:

- a.** If you are suspending construction activities due to frozen conditions, you may temporarily suspend inspections on your site until thawing conditions (as defined in Appendix A) begin to occur if:
 - i.** Discharges are unlikely due to continuous frozen conditions that are likely to continue at your site for at least three (3) months based on historic seasonal averages.⁷³ If unexpected weather conditions (such as above freezing temperatures or rain events) make discharges likely, you must immediately resume your regular inspection frequency as described in Parts 4.2 and 4.3, as applicable;
 - ii.** Land disturbances have been suspended; and
 - iii.** All disturbed areas of the site have been stabilized in accordance with Part 2.2.14a.
- b.** If you are still conducting construction activities during frozen conditions, you may reduce your inspection frequency to once per month if:
 - i.** Discharges are unlikely due to continuous frozen conditions that are likely to continue at your site for at least three (3) months based on historic seasonal averages. If unexpected weather conditions (such as above freezing temperatures or rain events) make discharges likely, you must immediately resume your regular inspection frequency as described in Parts 4.2 and 4.3, as applicable; and
 - ii.** Except for areas in which you are actively conducting construction activities, disturbed areas of the site have been stabilized in accordance with Part 2.2.14a.

You must document the beginning and ending dates of this period in your SWPPP.

4.5 AREAS THAT MUST BE INSPECTED

During your site inspection, you must at a minimum inspect the following areas of your site:

- 4.5.1** All areas that have been cleared, graded, or excavated and that have not yet completed stabilization consistent with Part 2.2.14a;
- 4.5.2** All stormwater controls, including pollution prevention controls, installed at the site to comply with this permit;⁷⁴
- 4.5.3** Material, waste, borrow, and equipment storage and maintenance areas that are covered by this permit;
- 4.5.4** All areas where stormwater typically flows within the site, including constructed or natural site drainage features designed to divert, convey, and/or treat stormwater;

⁷³ Use data sets that include the most recent data available to account for recent precipitation patterns and trends.

⁷⁴ This includes the requirement to inspect for sediment that has been tracked out from the site onto paved roads, sidewalks, or other paved areas consistent with Part 2.2.4.

- 4.5.5 All areas where construction dewatering is taking place, including controls to treat the dewatering discharge and any channelized flow of water to and from those controls;
- 4.5.6 All points of discharge from the site; and
- 4.5.7 All locations where stabilization measures have been implemented.

You are not required to inspect areas that, at the time of the inspection, are considered unsafe to your inspection personnel.

4.6 REQUIREMENTS FOR INSPECTIONS

4.6.1 During each site inspection, you must at a minimum:

- a. Check whether all stormwater controls (*i.e., erosion and sediment controls and pollution prevention controls*) are properly installed, appear to be operational, and are working as intended to minimize pollutant discharges.
- b. Check for the presence of conditions that could lead to spills, leaks, or other accumulations of pollutants on the site.
- c. Identify any locations where new or modified stormwater controls are necessary to meet the requirements of Parts 2 and/or 3.
- d. Check for signs of visible erosion and sedimentation (*i.e., sediment deposits*) that have occurred and are attributable to your discharge at points of discharge and, if applicable, on the banks of any receiving waters flowing within or immediately adjacent to the site;
- e. Check for signs of sediment deposition that are visible from your site and attributable to your discharge (e.g., sand bars with no vegetation growing on top in receiving waters or in other constructed or natural site drainage features, or the buildup of sediment deposits on nearby streets, curbs, or open conveyance channels).
- f. Identify any incidents of noncompliance observed.

4.6.2 If a discharge is occurring during your inspection:

- a. Identify all discharge points at the site; and
- b. Observe and document the visual quality of the discharge, and take note of the characteristics of the stormwater discharge, including color; odor; floating, settled, or suspended solids; foam; oil sheen; and other indicators of stormwater pollutants. Check also for signs of these same pollutant characteristics that are visible from your site and attributable to your discharge in receiving waters or in other constructed or natural site drainage features.

4.6.3 For dewatering inspections conducted pursuant to Parts 4.3.2, record the following in a report within 24 hours of completing the inspection:

- a. The inspection date;
- b. Names and titles of personnel making the inspection;
- c. Approximate times that the dewatering discharge began and ended on the day of inspection;⁷⁵

⁷⁵ If the dewatering discharge is a continuous discharge that continues after normal business hours,

- d. Estimates of the rate (in gallons per day) of discharge on the day of inspection;
- e. Whether or not any of the following indications of pollutant discharge were observed at the point of discharge to any receiving waters flowing through or immediately adjacent to the site and/or to constructed or natural site drainage features or storm drain inlets:⁷⁶
 - i. a sediment plume, suspended solids, unusual color, presence of odor, decreased clarity, or presence of foam; and/or
 - ii. a visible sheen on the water surface or visible oily deposits on the bottom or shoreline of the receiving water; and
- f. Photographs of (1) the dewatering water prior to treatment by a dewatering control(s) and the final discharge after treatment; (2) the dewatering control(s); and (3) the point of discharge to any receiving waters flowing through or immediately adjacent to the site and/or to constructed or natural site drainage features, storm drain inlets, and other conveyances to receiving waters.

You must also comply with the Part 4.7.2, 4.7.3, and 4.7.4 requirements for signing the reports, keeping them available on site, and retaining copies.

4.6.4 Based on the results of your inspection:

- a. Complete any necessary maintenance repairs or replacements under Part 2.1.4 or under Part 5, whichever applies; and
- b. Modify your SWPPP site map in accordance with Part 7.4.1 to reflect changes to your stormwater controls that are no longer accurately reflected on the current site map.

4.7 INSPECTION REPORT

4.7.1 You must complete an inspection report within 24 hours of completing any site inspection. Each inspection report (except for dewatering inspection reports, which are covered in Part 4.6.3) must include the following:

- a. The inspection date;
- b. Names and titles of personnel making the inspection;
- c. A summary of your inspection findings, covering at a minimum the observations you made in accordance with Part 4.6, including any problems found during your inspection that make it necessary to perform routine maintenance pursuant to Part 2.1.4b or corrective action pursuant to Part 5. Include also any documentation as to why the corrective action procedures under Part 5 are unnecessary to fix a problem that repeatedly occurs as described in Part 2.1.4c;
- d. If you are inspecting your site at the frequency specified in Part 4.2.2, Part 4.3, or Part 4.4.1b, and you conducted an inspection because of a storm event that produced rainfall measuring 0.25 inches or more within a 24-hour period, you must include the applicable rain gauge or weather station readings that triggered the inspection. Similarly, if you conducted an inspection because of a snowmelt discharge from a

indicate that the discharge is continuous.

⁷⁶ If the operator observes any of these indicators of pollutant discharge, corrective action is required consistent with Parts 5.1.5b and 5.2.2.

- storm event that produced 3.25 inches or more of snow within a 24-hour period, you must include any measurements taken of snowfall at your site, or weather station information you relied on; and
- e. If you determined that it is unsafe to inspect a portion of your site, you must describe the reason you found it to be unsafe and specify the locations to which this condition applies.
- 4.7.2** Each inspection report must be signed by the operator's signatory in accordance with Appendix G, Part G.11 of this permit.
- 4.7.3** You must keep a copy of all inspection reports at the site or at an easily accessible location, so that it can be made immediately available at the time of an on-site inspection or upon request by EPA.⁷⁷
- 4.7.4** You must retain all inspection reports completed for this Part for at least three (3) years from the date that your permit coverage expires or is terminated.

4.8 INSPECTIONS BY EPA

You must allow EPA, or an authorized representative of EPA, to conduct the following activities at reasonable times. To the extent that you are utilizing shared controls, that are not on site, to comply with this permit, you must make arrangements for EPA to have access at all reasonable times to those areas where the shared controls are located.

- 4.8.1** Enter onto all areas of the site, including any construction support activity areas covered by this permit, any off-site areas where shared controls are utilized to comply with this permit, discharge locations, adjoining waterbodies, and locations where records are kept under the conditions of this permit;
- 4.8.2** Access and copy any records that must be kept under the conditions of this permit;
- 4.8.3** Inspect your construction site, including any construction support activity areas covered by this permit (see Part 1.2.1 c), any stormwater controls installed and maintained at the site, and any off-site shared controls utilized to comply with this permit; and
- 4.8.4** Sample or monitor for the purpose of ensuring compliance.

5 CORRECTIVE ACTIONS

5.1 CONDITIONS TRIGGERING CORRECTIVE ACTION.

You must take corrective action to address any of the following conditions identified at your site:

- 5.1.1** A stormwater control needs a significant repair or a new or replacement control is needed, or, in accordance with Part 2.1.4c, you find it necessary to repeatedly (i.e., three (3) or more times) conduct the same routine maintenance fix to the same control at the same location (unless you document in your inspection report under Part 4.7.1c that the specific reoccurrence of this same problem should still be addressed as a routine

⁷⁷ Inspection reports may be prepared, signed, and kept electronically, rather than in paper form, if the records are: (a) in a format that can be read in a similar manner as a paper record; (b) legally dependable with no less evidentiary value than their paper equivalent; and (c) immediately accessible to the inspector during an inspection to the same extent as a paper copy stored at the site would be, if the records were stored in paper form. For additional guidance on the proper practices to follow for the electronic retention of inspection report records, refer to the Fact Sheet discussion related to Part 4.7.3.

maintenance fix under Part 2.1.4); or

- 5.1.2** A stormwater control necessary to comply with the requirements of this permit was never installed, or was installed incorrectly; or
- 5.1.3** Your discharges are not meeting applicable water quality standards;
- 5.1.4** A prohibited discharge has occurred (see Part 1.3); or
- 5.1.5** During discharge from site dewatering activities:
 - a.** The weekly average of your turbidity monitoring results exceeds the 50 NTU benchmark (or alternate benchmark if approved by EPA pursuant to Part 3.3.2b); or
 - b.** You observe or you are informed by EPA, State, or local authorities of the presence of the conditions specified in Part 4.6.3e.

5.2 CORRECTIVE ACTION DEADLINES

- 5.2.1** If responding to any of the Part 5.1.1, 5.1.2, 5.1.3, or 5.1.4 triggering conditions, you must:
 - a.** Immediately take all reasonable steps to address the condition, including cleaning up any contaminated surfaces so the material will not discharge in subsequent storm events; and
 - b.** When the problem does not require a new or replacement control or significant repair, the corrective action must be completed by the close of the next business day; or
 - c.** When the problem requires a new or replacement control or significant repair, install the new or modified control and make it operational, or complete the repair, by no later than seven (7) calendar days from the time of discovery. If it is infeasible to complete the installation or repair within seven (7) calendar days, you must document in your records why it is infeasible to complete the installation or repair within the 7-day timeframe and document your schedule for installing the stormwater control(s) and making it operational as soon as feasible after the 7-day timeframe. Where these actions result in changes to any of the stormwater controls or procedures documented in your SWPPP, you must modify your SWPPP accordingly within seven (7) calendar days of completing this work.
- 5.2.2** If responding to either of the Part 5.1.5 triggering conditions related to site dewatering activities, you must:
 - a.** Immediately take all reasonable steps to minimize or prevent the discharge of pollutants until you can implement a solution, including shutting off the dewatering discharge as soon as possible depending on the severity of the condition⁷⁸ taking safety considerations into account;
 - b.** Determine whether the dewatering controls are operating effectively and whether they are causing the conditions; and

⁷⁸ For instance, if the weekly average of your turbidity monitoring results or a single sample is extremely high (e.g., a single turbidity sample results in 355 NTUs or higher), you should take action to safely shut off the discharge so that you can evaluate the cause of the high turbidity. Note: A single turbidity sample of 355 NTUs or higher means that the weekly average turbidity value will exceed 50 NTU regardless of the turbidity values the other days during the week.

- c. Make any necessary adjustments, repairs, or replacements to the dewatering controls to lower the turbidity levels below the benchmark or remove the visible plume or sheen.

When you have completed these steps and made any changes deemed necessary, you may resume discharging from your dewatering activities.

5.3 CORRECTIVE ACTION REQUIRED BY EPA

You must comply with any corrective actions required by EPA as a result of permit violations found during an inspection carried out under Part 4.8.

5.4 CORRECTIVE ACTION LOG

- 5.4.1** For each corrective action taken in accordance with this Part, you must record the following in a corrective action log:

- a. Within 24 hours of identifying the corrective action condition, document the specific condition and the date and time it was identified.
- b. Within 24 hours of completing the corrective action (in accordance with the deadlines in Part 5.2), document the actions taken to address the condition, including whether any SWPPP modifications are required.

- 5.4.2** Each entry into the corrective action log, consisting of the information required by both Parts 5.4.1a and 5.4.1b, must be signed by the operator's signatory in accordance with Appendix G, Part G.11.2 of this permit.

- 5.4.3** You must keep a copy of the corrective action log at the site or at an easily accessible location, so that it can be made immediately available at the time of an on-site inspection or upon request by EPA.⁷⁹

- 5.4.4** You must retain the corrective action log for at least three (3) years from the date that your permit coverage expires or is terminated.

6 STORMWATER TEAM FORMATION/STAFF TRAINING REQUIREMENTS

6.1 STORMWATER TEAM

Each operator, or group of multiple operators, must assemble a "stormwater team" that will be responsible for carrying out activities necessary to comply with this permit. The stormwater team must include the following people:

- a. Personnel who are responsible for the design, installation, maintenance, and/or repair of stormwater controls (including pollution prevention controls);
- b. Personnel responsible for the application and storage of treatment chemicals (if applicable);
- c. Personnel who are responsible for conducting inspections as required in Part 4.1; and

⁷⁹ The corrective action log may be prepared, signed, and kept electronically, rather than in paper form, if the records are: (a) in a format that can be read in a similar manner as a paper record; (b) legally dependable with no less evidentiary value than their paper equivalent; and (c) immediately accessible to the inspector during an inspection to the same extent as a paper copy stored at the site would be, if the records were stored in paper form. For additional guidance on the proper practices to follow for the electronic retention of corrective action log records, refer to the Fact Sheet discussion related to Part 4.7.3.

- d. Personnel who are responsible for taking corrective actions as required in Part 5.

Members of the stormwater team must be identified in the SWPPP pursuant to Part 7.2.2.

6.2 GENERAL TRAINING REQUIREMENTS FOR STORMWATER TEAM MEMBERS

Prior to the commencement of construction activities, you must ensure that all persons⁸⁰ assigned to the stormwater team understand the requirements of this permit and their specific responsibilities with respect to those requirements, including the following related to the scope of their job duties:

- a. The permit requirements and deadlines associated with installation, maintenance, and removal of stormwater controls, as well as site stabilization;
- b. The location of all stormwater controls on the site required by this permit and how they are to be maintained;
- c. The proper procedures to follow with respect to the permit's pollution prevention requirements; and
- d. When and how to conduct inspections, record applicable findings, and take corrective actions. Specific training requirements for persons conducting site inspections are included in Part 6.3.

You are responsible for ensuring that all activities on the site comply with the requirements of this permit. You are not required to provide or document formal training for subcontractors or other outside service providers (unless the subcontractors or outside service providers are responsible for conducting the inspections required in Part 4, in which case you must provide such documentation consistent with Part 7.2.2), but you must ensure that such personnel understand any requirements of this permit that may be affected by the work they are subcontracted to perform.

6.3 TRAINING REQUIREMENTS FOR PERSONS CONDUCTING INSPECTIONS

For projects that receive coverage under this permit on or after February 17, 2023, to be considered a qualified person under Part 4.1 for conducting inspections under Part 4, you must, at a minimum, either:

- a. Have completed the EPA construction inspection course developed for this permit and have passed the exam; or
- b. Hold a current valid construction inspection certification or license from a program that, at a minimum, covers the following:⁸¹
 - i. Principles and practices of erosion and sediment control and pollution prevention practices at construction sites;
 - ii. Proper installation and maintenance of erosion and sediment controls and pollution prevention practices used at construction sites; and

⁸⁰ If the person requiring training is a new employee who starts after you commence construction activities, you must ensure that this person has the proper understanding as required above prior to assuming particular responsibilities related to compliance with this permit. For emergency-related projects, the requirement to train personnel prior to commencement of construction activities does not apply, however, such personnel must have the required training prior to NOI submission.

⁸¹ If one of the following topics (e.g., installation and maintenance of pollution prevention practices) is not covered by the non-EPA training program, you may consider supplementing the training with the analogous module of the EPA course (e.g., Module 4) that covers the missing topic.

- iii. Performance of inspections, including the proper completion of required reports and documentation, consistent with the requirements of Part 4.

For projects that receive coverage under this permit prior to February 17, 2023, any personnel conducting site inspections pursuant to Part 4 on your site must, at a minimum, be a person knowledgeable in the principles and practice of erosion and sediment controls and pollution prevention, who possesses the appropriate skills and training to assess conditions at the construction site that could impact stormwater quality, and the appropriate skills and training to assess the effectiveness of any stormwater controls selected and installed to meet the requirements of this permit.⁸²

6.4 STORMWATER TEAM'S ACCESS TO PERMIT DOCUMENTS

Each member of the stormwater team must have easy access to an electronic or paper copy of applicable portions of this permit, the most updated copy of your SWPPP, and other relevant documents or information that must be kept with the SWPPP.

7 STORMWATER POLLUTION PREVENTION PLAN (SWPPP)

7.1 GENERAL REQUIREMENTS

All operators associated with a construction site under this permit must develop a SWPPP consistent with the requirements in Part 7 prior to their submittal of the NOI.^{83, 84, 85} The SWPPP must be kept up-to-date throughout coverage under this permit.

If a SWPPP was prepared under a previous version of this permit, the operator must review and update the SWPPP to ensure that this permit's requirements are addressed prior to submitting an NOI for coverage under this permit.

⁸² If you receive coverage for a project prior to February 17, 2023, and construction activities for the same project will continue after February 17, 2023, the personnel conducting inspections do not need to take the additional training specified in Parts 6.3a and 6.3b for inspections conducted on the project site. If the same operator obtains coverage for a different project on or after February 17, 2023, personnel conducting inspections would be required to meet the requirements for a qualified person by completing the training in either Part 6.3a or Part 6.3b.

⁸³ The SWPPP does not establish the effluent limits and/or other permit terms and conditions that apply to your site's discharges; these limits, terms, and conditions are established in this permit.

⁸⁴ Where there are multiple operators associated with the same site, they may develop a group SWPPP instead of multiple individual SWPPPs. Regardless of whether there is a group SWPPP or multiple individual SWPPPs, each operator is responsible for compliance with the permit's terms and conditions. In other words, if Operator A relies on Operator B to satisfy its permit obligations, Operator A does not have to duplicate those permit-related functions if Operator B is implementing them such that both operators are in compliance with the permit. However, Operator A remains responsible for permit compliance if Operator B fails to take actions necessary for Operator A to comply with the permit. In addition, all operators must ensure, either directly or through coordination with other operators, that their activities do not cause a violation or compromise any other operators' controls and/or any shared controls. See also footnote 61.

⁸⁵ There are a number of commercially available products to assist operators in developing the SWPPP, as well as companies that can be hired to help develop a site-specific SWPPP. The permit does not state which are recommended, nor does EPA endorse any specific products or vendors. Where operators choose to rely on these products or services, the choice of which ones to use to comply with the requirements of this Part is a decision for the operator alone.

7.2 SWPPP CONTENTS

At a minimum, the SWPPP must include the information specified in this Part and as specified in other parts of this permit.

7.2.1 All Site Operators. Include a list of all other operators who will be engaged in construction activities at the site, and the areas of the site over which each operator has control.

7.2.2 Stormwater Team. Identify the personnel (by name and position) that you have made part of the stormwater team pursuant to Part 6.1, as well as their individual responsibilities, including which members are responsible for conducting inspections.

Include verification that each member of the stormwater team has received the training required by Part 6.2. Include documentation that members of the stormwater team responsible for conducting inspections pursuant to Part 4 have received the training required by Part 6.3. If personnel on your team elect to complete the EPA inspector training program pursuant to Part 6.3a, you must include copies of the certificate showing that the relevant personnel have completed the training and passed the exam. If personnel on your team elect to complete a non-EPA inspector training program pursuant to Part 6.3b, you must include documentation showing that these persons have successfully completed the program and their certification or license is still current. You must also confirm that the non-EPA inspector training program satisfies the minimum elements for such programs in Part 6.3b.

7.2.3 Nature of Construction Activities. Include the following:

- a. A description of the nature of your construction activities, including the age or dates of past renovations for structures that are undergoing demolition;
- b. The size of the property (in acres or length in miles if a linear construction site);
- c. The total area expected to be disturbed by the construction activities (to the nearest quarter acre or nearest quarter mile if a linear construction site);
- d. A description of any on-site and off-site construction support activity areas covered by this permit (see Part 1.2.1 c);
- e. The maximum area expected to be disturbed at any one time, including on-site and off-site construction support activity areas;
- f. A description and projected schedule for the following:⁸⁶
 - i. Commencement of construction activities in each portion of the site, including clearing and grubbing, mass grading, demolition activities, site preparation (i.e., excavating, cutting and filling), final grading, and creation of soil and vegetation stockpiles requiring stabilization;
 - ii. Temporary or permanent cessation of construction activities in each portion of the site;
 - iii. Temporary or final stabilization of exposed areas for each portion of the site; and
 - iv. Removal of temporary stormwater controls and construction equipment or vehicles, and the cessation of construction-related pollutant-generating activities.

⁸⁶ If plans change due to unforeseen circumstances or for other reasons, the requirement to describe the sequence and estimated dates of construction activities is not meant to "lock in" the operator to meeting these dates. When departures from initial projections are necessary, this should be documented in the SWPPP itself, or in associated records, as appropriate.

- g.** A list and description of all pollutant-generating activities⁸⁷ on the site. For each pollutant-generating activity, include an inventory of pollutants or pollutant constituents (e.g., *sediment, fertilizers, pesticides, paints, caulks, sealants, fluorescent light ballasts, contaminated substrates, solvents, fuels*) associated with that activity, which could be discharged in stormwater from your construction site. You must take into account where potential spills and leaks could occur that contribute pollutants to stormwater discharges, and any known hazardous or toxic substances, such as PCBs and asbestos, that will be disturbed or removed during construction;
 - h.** Business days and hours for the project;
 - i.** If you are conducting construction activities in response to a public emergency (see Part 1.4), a description of the cause of the public emergency (e.g., *mud slides, earthquake, extreme flooding conditions, widespread disruption in essential public services*), information substantiating its occurrence (e.g., *State disaster declaration or similar State or local declaration*), and a description of the construction necessary to reestablish affected public services.
- 7.2.4 Site Map.** Include a legible map, or series of maps, showing the following features of the site:
- a.** Boundaries of the property;
 - b.** Locations where construction activities will occur, including:
 - i.** Locations where earth-disturbing activities will occur (note any phasing), including any demolition activities;
 - ii.** Approximate slopes before and after major grading activities (note any steep slopes (as defined in Appendix A));
 - iii.** Locations where sediment, soil, or other construction materials will be stockpiled;
 - iv.** Any receiving water crossings;
 - v.** Designated points where vehicles will exit onto paved roads;
 - vi.** Locations of structures and other impervious surfaces upon completion of construction; and
 - vii.** Locations of on-site and off-site construction support activity areas covered by this permit (see Part 1.2.1c).
 - c.** Locations of any receiving waters within the site and all receiving waters within one mile downstream of the site's discharge point(s). Also identify if any of these receiving waters are listed as impaired or are identified as a Tier 2, Tier 2.5, or Tier 3 water;
 - d.** Any areas of Federally listed critical habitat within the action area of the site as defined in Appendix A;
 - e.** Type and extent of pre-construction cover on the site (e.g., vegetative cover, forest, pasture, pavement, structures);
 - f.** Drainage patterns of stormwater and authorized non-stormwater before and after major grading activities;

⁸⁷ Examples of pollutant-generating activities include paving operations; concrete, paint, and stucco washout and waste disposal; solid waste storage and disposal; and dewatering activities.

- g.** Stormwater and authorized non-stormwater discharge locations, including:
 - i.** Locations where stormwater and/or authorized non-stormwater will be discharged to storm drain inlets, including a notation of whether the inlet conveys stormwater to a sediment basin, sediment trap, or similarly effective control;⁸⁸
 - ii.** Locations where stormwater or authorized non-stormwater will be discharged directly to receiving waters (i.e., not via a storm drain inlet); and
 - iii.** Locations where turbidity benchmark monitoring will take place to comply with Part 3.3, if applicable to your site.
- h.** Locations of all potential pollutant-generating activities identified in Part 7.2.3g;
- i.** Designated areas where construction wastes that are covered by the exception in Part 2.3.3e.ii because they are not pollutant-generating will be stored;
- j.** Locations of stormwater controls, including natural buffer areas and any shared controls utilized to comply with this permit; and
- k.** Locations where polymers, flocculants, or other treatment chemicals will be used and stored.

7.2.5 Non-Stormwater Discharges. Identify all authorized non-stormwater discharges in Part 1.2.2 that will or may occur.

7.2.6 Description of Stormwater Controls.

- a.** For each of the Part 2.2 erosion and sediment control requirements, Part 2.3 pollution prevention requirements, and Part 2.4 construction dewatering requirements, as applicable to your site, you must include the following:
 - i.** A description of the specific control(s) to be implemented to meet these requirements;
 - ii.** The design specifications for controls described in Part 7.2.6a.i (including references to any manufacturer specifications and/or erosion and sediment control manuals/ordinances relied upon);⁸⁹
 - iii.** Routine stormwater control maintenance specifications; and
 - iv.** The projected schedule for stormwater control installation/implementation.
- b.** You must also include any of the following additional information as applicable.
 - i. Natural buffers and/or equivalent sediment controls** (see Part 2.2.1 and Appendix F). You must include the following:
 - (a) The compliance alternative to be implemented;
 - (b) If complying with alternative 2, the width of natural buffer retained;

⁸⁸ The requirement to show storm drain inlets in the immediate vicinity of the site on your site map only applies to those inlets that are easily identifiable from your site or from a publicly accessible area immediately adjacent to your site.

⁸⁹ Design specifications may be found in manufacturer specifications and/or in applicable erosion and sediment control manuals or ordinances. Any departures from such specifications must reflect good engineering practice and must be explained in the SWPPP.

- (c) If complying with alternative 2 or 3, the erosion and sediment control(s) you will use to achieve an equivalent sediment reduction, and any information you relied upon to demonstrate the equivalency;
 - (d) If complying with alternative 3, a description of why it is infeasible for you to provide and maintain an undisturbed natural buffer of any size;
 - (e) For "linear construction sites" where it is infeasible to implement compliance alternative 1, 2, or 3, a rationale for this determination, and a description of any buffer width retained and/or supplemental erosion and sediment controls installed; and
 - (f) A description of any disturbances that are exempt under Part 2.2.1 that occur within 50 feet of a receiving water.
- ii. Perimeter controls for a "linear construction site"** (see Part 2.2.3d). For areas where perimeter controls are not feasible, include documentation to support this determination and a description of the other practices that will be implemented to minimize discharges of pollutants in stormwater associated with construction activities.
- Note: Routine maintenance specifications for perimeter controls documented in the SWPPP must include the Part 2.2.3c.i requirement that sediment be removed before it has accumulated to one-half of the above-ground height of any perimeter control.
- iii. Sediment track-out controls** (see Parts 2.2.4b and 2.2.4c). Document the specific stabilization techniques and/or controls that will be implemented to remove sediment prior to vehicle exit.
- iv. Inlet protection measures** (see Part 2.2.10a). Where inlet protection measures are not required because the storm drain inlets to which your site discharges are conveyed to a sediment basin, sediment trap, or similarly effective control, include a short description of the control that receives the stormwater flow from the site.
- v. Sediment basins** (see Part 2.2.12). In circumstances where it is infeasible to utilize outlet structures that withdraw water from the surface, include documentation to support this determination, including the specific conditions or time periods when this exception will apply.
- vi. Treatment chemicals** (see Part 2.2.13), you must include the following:
- (a) A listing of the soil types that are expected to be exposed during construction in areas of the project that will drain to chemical treatment systems. Also include a listing of soil types expected to be found in fill material to be used in these same areas, to the extent you have this information prior to construction;
 - (b) A listing of all treatment chemicals to be used at the site and why the selection of these chemicals is suited to the soil characteristics of your site;
 - (c) If the applicable EPA Regional Office authorized you to use cationic treatment chemicals for sediment control, include the specific controls and implementation procedures designed to ensure that your use of cationic

treatment chemicals will not lead to a discharge that does not meet water quality standards;

- (d) The dosage of all treatment chemicals to be used at the site or the methodology to be used to determine dosage;
- (e) Information from any applicable Safety Data Sheet (SDS);
- (f) Schematic drawings of any chemically enhanced stormwater controls or chemical treatment systems to be used for application of the treatment chemicals;
- (g) A description of how chemicals will be stored consistent with Part 2.2.13c;
- (h) References to applicable State or local requirements affecting the use of treatment chemicals, and copies of applicable manufacturer's specifications regarding the use of your specific treatment chemicals and/or chemical treatment systems; and
- (i) A description of the training that personnel who handle and apply chemicals have received prior to permit coverage, or will receive prior to use of the treatment chemicals at your site.

vii. Stabilization measures (see Part 2.2.14). You must include the following:

- (a) The specific vegetative and/or non-vegetative practices that will be used;
- (b) The stabilization deadline that will be met in accordance with Part 2.2.14;
- (c) If complying with the deadlines for sites in arid, semi-arid, or drought-stricken areas, the beginning and ending dates of the seasonally dry period (as defined in Appendix A)⁹⁰ and the schedule you will follow for initiating and completing vegetative stabilization; and
- (d) If complying with deadlines for sites affected by unforeseen circumstances that delay the initiation and/or completion of vegetative stabilization, document the circumstances and the schedule for initiating and completing stabilization.

viii. Spill prevention and response procedures (see Parts 1.3.5, 2.3.3c, 2.3.3d, and 2.3.6). You must include the following:

- (a) Procedures for expeditiously stopping, containing, and cleaning up spills, leaks, and other releases. Identify the name or position of the employee(s) responsible for detection and response of spills or leaks; and
- (b) Procedures for notification of appropriate facility personnel, emergency response agencies, and regulatory agencies where a leak, spill, or other release containing a hazardous substance or oil in an amount equal to or in excess of a reportable quantity consistent with Part 2.3.6 and established under either 40 CFR part 110, 40 CFR part 117, or 40 CFR part 302, occurs

⁹⁰ See footnote 45.

during a 24-hour period. Contact information must be in locations that are readily accessible and available to all employees.

You may also reference the existence of SPCC plans developed for the construction activity under Section 311 of the CWA, or spill control programs otherwise required by an NPDES permit for the construction activity, provided that you keep a copy of that other plan on site.⁹¹

ix. Waste management procedures (see Part 2.3.3). Describe the procedures you will follow for handling, storing, and disposing of all wastes generated at your site consistent with all applicable Federal, State, Tribal, and local requirements, including clearing and demolition debris, sediment removed from the site, construction and domestic waste, hazardous or toxic waste, and sanitary waste. You must also include the following additional information:

- (a) If site constraints prevent you from storing chemical containers 50 feet away from receiving waters or the other site drainage features as required in Part 2.3.3c.ii(b), document in your SWPPP the specific reasons why the 50-foot setback is not feasible, and how you will store containers as far away as the site permits; and
- (b) If there are construction wastes that are subject to the exception in Part 2.3.3e.ii, describe the specific wastes that will be stored on your site.

x. Application of fertilizers (see Part 2.3.5). Document any departures from the manufacturer specifications where appropriate.

7.2.7 Procedures for Inspection, Maintenance, and Corrective Action. Describe the procedures you will follow for maintaining your stormwater controls, conducting site inspections, and, where necessary, taking corrective actions, in accordance with Part 2.1.4, Part 4, and Part 5 of this permit, accordingly. Also include:

- a.** The inspection schedule you will follow, which is based on whether your site is subject to Part 4.2 or Part 4.3, or whether your site qualifies for any of the reduced inspection frequencies in Part 4.4;
- b.** If you will be conducting inspections in accordance with the inspection schedule in Part 4.2.2, Part 4.3, or Part 4.4.1b, the location of the rain gauge or the address of the weather station you will be using to obtain rainfall data;
- c.** If you will be reducing your inspection frequency in accordance with Part 4.4.1b, the beginning and ending dates of the seasonally defined arid period for your area or the valid period of drought;
- d.** If you will be reducing your inspection frequency in accordance with Part 4.4.3, the beginning and ending dates of frozen conditions on your site; and
- e.** Any maintenance or inspection checklists or other forms that will be used.

7.2.8 Procedures for Turbidity Benchmark Monitoring from Dewatering Discharges (if applicable). If you are required to comply with the Part 3.3 turbidity benchmark

⁹¹ Even if you already have an SPCC or other spill prevention plan in existence, your plans will only be considered adequate if they meet all of the requirements of this Part, either as part of your existing plan or supplemented as part of the SWPPP.

monitoring requirements, describe the procedures you will follow to collect and evaluate samples, report results to EPA and keep records of monitoring information, and take corrective action when necessary. Include the specific type of turbidity meter you will use for monitoring, as well as any manuals or manufacturer instructions on how to operate and calibrate the meter. Describe any coordinating arrangement you may have with any other permitted operators on the same site with respect to compliance with the turbidity monitoring requirements, including which parties are tasked with specific responsibilities. If EPA has approved of an alternate turbidity benchmark pursuant to Part 3.3.2b, include any data and other documentation you relied on to request use of the specific alternative benchmark.

7.2.9 Compliance with Other Requirements.

- a. Threatened and Endangered Species Protection.** Include documentation required in the Endangered Species Protection section of the NOI in NeT, or the ESA worksheet in Appendix D, supporting your eligibility with regard to the protection of threatened and endangered species and designated critical habitat.
- b. Historic Properties.** Include documentation required in Appendix E supporting your eligibility with regard to the protection of historic properties.
- c. Safe Drinking Water Act Underground Injection Control (UIC) Requirements for Certain Subsurface Stormwater Controls.** If you are using any of the following stormwater controls at your site, document any contact you have had with the applicable State agency⁹² or EPA Regional Office responsible for implementing the requirements for underground injection wells in the Safe Drinking Water Act and EPA's implementing regulations at 40 CFR § 144 -147. Such controls would generally be considered Class V UIC wells:
 - i.** Infiltration trenches (if stormwater is directed to any bored, drilled, driven shaft or dug hole that is deeper than its widest surface dimension, or has a subsurface fluid distribution system);
 - ii.** Commercially manufactured pre-cast or pre-built proprietary subsurface detention vaults, chambers, or other devices designed to capture and infiltrate stormwater flow; and
 - iii.** Drywells, seepage pits, or improved sinkholes (if stormwater is directed to any bored, drilled, driven shaft or dug hole that is deeper than its widest surface dimension, or has a subsurface fluid distribution system).

7.2.10 SWPPP Certification. Your signatory must sign and date your SWPPP in accordance with Appendix G, Part G.11.

7.2.11 Post-Authorization Additions to the SWPPP. Once you are authorized for coverage under this permit, you must include the following documents as part of your SWPPP:

- a.** A copy of your NOI submitted to EPA along with any correspondence exchanged between you and EPA related to coverage under this permit;
- b.** A copy of the acknowledgment letter you receive from NeT assigning your NPDES ID (i.e., *permit tracking number*);

⁹² For State UIC program contacts, refer to the following EPA website: <https://www.epa.gov/uic>.

- c. A copy of this permit (an electronic copy easily available to the stormwater team is also acceptable).

7.3 ON-SITE AVAILABILITY OF YOUR SWPPP

You must keep a current copy of your SWPPP at the site or at an easily accessible location so that it can be made available at the time of an on-site inspection or upon request by EPA; a State, Tribal, or local agency approving stormwater management plans; the operator of a storm sewer system receiving discharges from the site; or representatives of the U.S. Fish and Wildlife Service (USFWS) or the National Marine Fisheries Service (NMFS).⁹³

EPA may provide access to portions of your SWPPP to a member of the public upon request. Confidential Business Information (CBI) will be withheld from the public, but may not be withheld from EPA, USFWS, or NMFS.⁹⁴

If an on-site location is unavailable to keep the SWPPP when no personnel are present, notice of the plan's location must be posted near the main entrance of your construction site.

7.4 SWPPP MODIFICATIONS

7.4.1 You must modify your SWPPP, including the site map(s), within seven (7) days of any of the following conditions:

- a. Whenever new operators become active in construction activities on your site, or you make changes to your construction plans, stormwater controls, or other activities at your site that are no longer accurately reflected in your SWPPP. This includes changes made in response to corrective actions triggered under Part 5. You do not need to modify your SWPPP if the estimated dates in Part 7.2.3f change during the course of construction;
- b. To reflect areas on your site map where operational control has been transferred (and the date of transfer) since initiating permit coverage;
- c. If inspections or investigations by EPA or its authorized representatives determine that SWPPP modifications are necessary for compliance with this permit;
- d. Where EPA determines it is necessary to install and/or implement additional controls at your site in order to meet the requirements of this permit, the following must be included in your SWPPP:
 - i. A copy of any correspondence describing such measures and requirements; and

⁹³ The SWPPP may be prepared, signed, and kept electronically, rather than in paper form, if the records are: (a) in a format that can be read in a similar manner as a paper record; (b) legally dependable with no less evidentiary value than their paper equivalent; and (c) immediately accessible to the inspector during an inspection to the same extent as a paper copy stored at the site would be, if the records were stored in paper form. For additional guidance on the proper practices to follow for the electronic retention of the SWPPP, refer to the Fact Sheet discussion related to Part 4.7.3.

⁹⁴ Information covered by a claim of confidentiality will be disclosed by EPA only to the extent of, and by means of, the procedures set forth in 40 CFR part 2, Subpart B. In general, submitted information protected by a business confidentiality claim may be disclosed to other employees, officers, or authorized representatives of the United States concerned with implementing the CWA. The authorized representatives, including employees of other executive branch agencies, may review CBI during the course of reviewing draft regulations.

- ii. A description of the controls that will be used to meet such requirements.
 - e. To reflect any revisions to applicable Federal, State, Tribal, or local requirements that affect the stormwater controls implemented at the site; and
 - f. If applicable, if a change in chemical treatment systems or chemically enhanced stormwater control is made, including use of a different treatment chemical, different dosage rate, or different area of application.
- 7.4.2** You must maintain records showing the dates of all SWPPP modifications. The records must include the name of the person authorizing each change (see Part 7.2.9 above) and a brief summary of all changes.
- 7.4.3** All modifications made to the SWPPP consistent with Part 7.4 must be authorized by a person identified in Appendix G, Part G.11.b.
- 7.4.4** Upon determining that a modification to your SWPPP is required, if there are multiple operators covered under this permit, you must immediately notify any operators who may be impacted by the change to the SWPPP.

8 HOW TO TERMINATE COVERAGE

Until you terminate coverage under this permit, you must comply with all conditions and effluent limitations in the permit. To terminate permit coverage, you must submit to EPA a complete and accurate Notice of Termination (NOT), which certifies that you have met the requirements for terminating in Part 8.

8.1 MINIMUM INFORMATION REQUIRED IN NOT

- 8.1.1** NPDES ID (i.e., *permit tracking number*) provided by EPA when you received coverage under this permit;
- 8.1.2** Basis for submission of the NOT (see Part 8.2);
- 8.1.3** Operator contact information;
- 8.1.4** Name of site and address (or a description of location if no street address is available); and
- 8.1.5** NOT certification.

8.2 CONDITIONS FOR TERMINATING CGP COVERAGE

You may terminate CGP coverage only if one or more of the conditions in Parts 8.2.1, 8.2.2, or 8.2.3 has occurred. Until your termination is effective consistent with Part 8.5, you must continue to comply with the conditions of this permit.

- 8.2.1** You have completed all construction activities at your site and, if applicable, construction support activities covered by this permit (see Part 1.2.1c), and you have met all of the following requirements:
 - a. For any areas that (1) were disturbed during construction, (2) are not covered by permanent structures, and (3) over which you had control during the construction activities, you have met the requirements for final vegetative or non-vegetative stabilization in Part 2.2.14c.

To document that you have met these stabilization requirements, you must take either ground or aerial photographs that show your site's compliance with the Part 2.2.14 stabilization requirements and submit them with your NOT. If any portion of your

site is covered by one of the exceptions in Part 2.2.14c.iii, indicate which exception applies and include a supplementary explanation with your photographs that provides the necessary context for why this portion of the site is in compliance with the final stabilization criteria even though it appears to be unstabilized. You are not required to take photographs of every distinct part of your site that is being stabilized, however, the conditions of the site portrayed in any photographs that are submitted must be substantially similar⁹⁵ to those of the areas that are not photographed. You must also comply with the following related to these photographs:

- i. Take photographs both before and after the site has met the final stabilization criteria in Part 2.2.14c;
 - ii. All photographs must be clear and in focus, and in the original format and resolution; and
 - iii. Include the date each photograph was taken, and a brief description of the area of the site captured by the photograph (e.g., photo shows application of seed and erosion control mats to remaining exposed surfaces on northeast corner of site).
- b. You have removed and properly disposed of all construction materials, waste and waste handling devices, and have removed all equipment and vehicles that were used during construction, unless intended for long-term use following your termination of permit coverage;
 - c. You have removed all stormwater controls that were installed and maintained during construction, except those that are intended for long-term use following your termination of permit coverage or those that are biodegradable (as defined in Appendix A); and
 - d. You have removed all potential pollutants and pollutant-generating activities associated with construction, unless needed for long-term use following your termination of permit coverage; or
- 8.2.2** You have transferred control of all areas of the site for which you are responsible under this permit to another operator, and that operator has submitted an NOI and obtained coverage under this permit; or
- 8.2.3** Coverage under an individual or alternative general NPDES permit has been obtained.

8.3 HOW TO SUBMIT YOUR NOT

You must use EPA's NPDES eReporting Tool (NeT) to electronically prepare and submit an NOT for the 2022 CGP.

To access NeT, go to <https://cdx.epa.gov/cdx>.

Waivers from electronic reporting may be granted as specified in Part 1.4.2. If the EPA Regional Office grants you approval to use a paper NOT, and you elect to use it, you must complete the form in Appendix I.

⁹⁵ Stabilization conditions that are substantially similar would include areas that are using the same type of stabilization measures and that have similar slopes, soils, and topography, and have achieved the same level of stabilization.

8.4 DEADLINE FOR SUBMITTING THE NOT

You must submit an NOT within 30 calendar days after any one of the conditions in Part 8.2 occurs.

8.5 EFFECTIVE DATE OF TERMINATION OF COVERAGE

Your authorization to discharge under this permit terminates at midnight of the calendar day that a complete NOT is submitted to EPA.

9 PERMIT CONDITIONS APPLICABLE TO SPECIFIC STATES, INDIAN COUNTRY LANDS, OR TERRITORIES

The provisions in this Part provide additions to the applicable conditions of this permit to reflect specific additional conditions required as part of the State or Tribal CWA Section 401 certification process, or the Coastal Zone Management Act (CZMA) certification process, or as otherwise established by the permitting authority. The specific additional revisions and requirements only apply to activities in those specific States, Indian country, and areas in certain States with Federal Facilities or areas subject to construction projects by Federal Operators. States, Indian country, and other areas not included in this Part do not have any additions to the applicable conditions of this permit.

9.1 EPA REGION 1

9.1.1 NHR100000 State of New Hampshire

- a.** Should the permit coverage for an individual applicant be insufficient to achieve water quality standards, the New Hampshire Department of Environmental Services (NHDES) may prepare additional 401 certification conditions for that applicant. Any additional 401 certification conditions will follow all required NHDES public participation requirements.
- b.** If you disturb 100,000 square feet or more of contiguous area, you must also comply with RSA 485-A:17 and Env-Wq 1500, and, unless exempt, apply for an Alteration of Terrain (AoT) permit from NHDES. This requirement also applies to a lower disturbance threshold of 50,000 square feet or more when construction occurs within the protected shoreline under the Shoreland Water Quality Protection Act (see RSA 483-B and Env-Wq 1400). A permit application must also be filed if your project disturbs an area of greater than 2,500 square feet, is within 50 feet of any surface water, and has a flow path of 50 feet or longer disturbing a grade of 25 percent or greater. Project sites with disturbances smaller than those discussed above, that have the potential to adversely affect state surface waters, are subject to the conditions of an AoT General Permit by Rule (Env-Wq 1503.03).
- c.** You must determine that any excavation dewatering discharges are not contaminated before they will be authorized as an allowable non-stormwater discharge under this permit (see Part 1.2.2 of the Construction General Permit or CGP). In the absence of information demonstrating otherwise, the water is considered uncontaminated if there is no groundwater contamination within 1,000 feet of the groundwater dewatering location. Information on groundwater contamination can be generated over the Internet via the NHDES web site <http://des.nh.gov/> by using the One Stop Data Mapper. For a toxic substance included in the New Hampshire surface water quality standards, see Env-Wq 1703.21 (see <https://www.des.nh.gov/sites/g/files/ehbemt341/files/documents/2020-01/Env-Wg>

1700.pdf). If it is determined that the groundwater to be dewatered is near a remediation or other waste site, you must apply for the Remediation General Permit (see <https://www3.epa.gov/region1/npdes/rgp.html>)

- d.** As a minimum, you must treat any uncontaminated excavation "dewatering" discharges and "stormwater" discharges, as those terms are defined in Appendix A of the CGP, as necessary, to remove suspended solids and turbidity so that the surface waters receiving the construction discharges⁹⁶ meet New Hampshire surface water quality standards for turbidity (Env-Wq 1703.11 and Env-Wq 1703.03(c)(1)c), benthic deposits (Env-Wq 1703.03(c)(1)a), and Env-Wq 1703.08) and foam, debris, scum or other visible substances (i.e., plumes or visual turbidity)⁹⁷ (Env-Wq 1703.03(c)(1)b).
- i.** For all Construction Activities covered under this CGP, the following shall apply to ensure compliance with the aforementioned regulations for turbidity, benthic deposits and visible substances:
- Unless otherwise specified, site inspection requirements shall comply with Part 4 of the CGP. As a minimum site inspection frequency shall be in accordance with Part 4.2.2 of the CGP (and Part 4.3.2 of the CGP for sites discharging dewatering water). Site inspection frequency may be reduced in accordance with Part 4.4 of the CGP (Reductions in Inspection Frequency). Monitoring of the receiving water for visible turbidity and benthic sediment deposits shall be conducted each site inspection and results reported in the Inspection Report required in Part 4.7 of the CGP. Should visible turbidity or benthic sediment deposits attributable or partly attributable to your construction activities be present in the receiving water, the "Corrective Actions" specified in Part 5 shall be immediately implemented to correct the water quality standard violations. In addition, daily monitoring (including photographs) of the receiving water shall be conducted until there is no visible turbidity or benthic deposits. Inspection Reports required in Part 4.7 of the CGP shall include, but not be limited to, the distance downstream and the percent of the river width⁹⁸ where visible turbidity was observed, and the period of time that the visible turbidity persisted. A copy of the Inspection Report(s) shall be made available to NHDES within 24 hours of receiving a written request from NHDES.
- ii.** For Construction Activities, disturbing 5 acres or more of land at any one time (excluding areas that have been completely stabilized in accordance with the final stabilization criteria specified in Part 2.2.14.c of the CGP), the following shall

⁹⁶ Construction Discharges include uncontaminated "dewatering" and "stormwater" discharges as those terms are defined in Appendix A of the CGP. Controlled construction discharges are construction discharges where the rate of flow can be regulated such as from a construction settling basin or NHDES approved flocculation system.

⁹⁷ For the definition of visual turbidity, see the definition for "Non-Turbid" in Appendix A of the CGP, which states the following: "Non-Turbid" - a discharge that is free from visual turbidity. For the purposes of this permit, visual turbidity refers to a sediment plume or other cloudiness in the water caused by sediment that can be identified by an observer." [EPA interprets the text of this footnote as intending to reference the Appendix A definitions of "visual turbidity" and "non-turbid" in the final permit.]

⁹⁸ The distance downstream and the percent of river width where visible turbidity (i.e., plume) is observed is required to determine the extent of the river affected and to determine if there was a "zone of passage" (i.e., a portion of the receiving water where there was no visible turbidity where mobile organisms could pass without being adversely impacted). The percent of river width affected is equal 100 multiplied by the width of the plume (in feet) divided by the width of the receiving water (in feet).

apply to ensure compliance with the aforementioned regulations for turbidity, benthic deposits and visible substances.

Item 9.1.1.d.i) above shall apply to all construction discharges and the minimum site inspection frequency shall comply with Part 4.3.1 of the CGP (and Part 4.3.2 of the CGP for sites discharging dewatering water). Site inspection frequency may be reduced in accordance with Part 4.4 of the CGP (Reductions in Inspection Frequency).

With regards to controlled construction discharges, if there is no visible turbidity (i.e., plumes) or benthic deposits, and, in the absence of information demonstrating otherwise, turbidity measurements of less than or equal to 50 nephelometric turbidity units (NTU) in the controlled construction discharges at the outlet prior to mixing with the receiving surface waters, shall be presumed to meet New Hampshire surface water quality standards for the parameters listed above. As a minimum, the controlled construction discharges must be sampled at each site inspection.

If any controlled construction discharge exceeds 50 NTU, or if visible turbidity or benthic sediment deposits attributable or partly attributable to any construction discharge are observed in the receiving water, then the "Corrective Actions" specified in Part 5 of the CGP shall be immediately implemented.

In addition, should such violation occur, and, in order to determine compliance with surface water quality standards for turbidity (Env-Wq 1703.11 and Env-Wq 1703.03(c)(1)c), benthic deposits (Env-Wq 1703.03(c)(1)a), and Env-Wq 1703.08) and foam, debris, scum or other visible substances (Env-Wq 1703.03(c)(1)b)), turbidity monitoring shall be immediately implemented as specified below:

Turbidity samples of the receiving water shall be immediately taken in the receiving water upstream and beyond the influence of the construction activity, and, unless a mixing zone⁹⁹ is approved by NHDES, no more than 75 feet downstream of each controlled construction discharge that exceeded 50 NTU and no more than 75 feet downstream of each construction discharge that caused visible turbidity.

Downstream samples shall be taken at locations in the receiving water that are most likely influenced by the discharge (e.g., if visible turbidity (i.e., a plume) is present, the sample shall be taken in the plume). Samples shall be collected a minimum of 2 times per day during the daylight hours at times when construction activities are most likely to cause turbidity in the receiving water and shall continue until the turbidity water quality standards are met in the receiving water (i.e., the difference between the upstream and downstream turbidity level is no greater than 10 NTU).

⁹⁹ Permittees may request a distance greater than 75 feet downstream of a construction discharge for determining compliance with turbidity standards in Class B surface waters, by submitting a mixing zone request to NHDES that complies with Env-Wq 1707.02. If a mixing zone is approved, NHDES is required to include conditions to ensure that the criteria on which the approval is based are met (Env-Wq 1707.03).

If water quality standards are not met during daylight hours on any day, sampling shall resume the next day and continue no fewer than 2 times per day until water quality standards are met. The date, time, location and results of turbidity measurements, as well as a summary identifying the cause of the violations, corrective actions that were implemented, the period of time that the receiving water exceeded turbidity standards and the distance downstream and the percent of the river width where visible turbidity was observed, and the period of time that the visible turbidity persisted, shall be recorded and included in the Inspection Report required in Part 4.7 of the CGP. Turbidity measurements shall be conducted via a field meter in accordance with the requirements for turbidity specified in Table 1B in 40 CFR 136.3 (see 40 CFR §136.3 Identification of test procedures - Code of Federal Regulations ecfrio). Field meters shall be calibrated every day sampling is conducted and prior to the first sample.

- e. Construction site owners and operators are encouraged to consider opportunities for post- construction groundwater recharge using infiltration best management practices (BMPs) during site design and preparation of the SWPPP in order to assure compliance with Env-Wq 1703.03 and Env-Wq 1703.11. If your construction site is in a town that is required to obtain coverage under the NPDES General Permit for discharges from Municipal Separate Storm Sewer Systems (MS4) you may be required to use such practices. The SWPPP must include a description of any on-site infiltration that will be installed as a post-construction stormwater management measure or reasons for not employing such measures such as 1) The facility is located in a wellhead protection area as defined in RSA 485- C:2; or 2) The facility is located in an area where groundwater has been reclassified to GAA, GA1 or GA2 pursuant to RSA 485-C and Env-DW 901; or 3) Any areas that would be exempt from the groundwater recharge requirements contained in Env-Wq 1507.04, including all land uses or activities considered to be a "High-load Area" (see Env-Wq 1502.30). For design considerations for infiltration measures see Env-Wq 1508.06. Note that there may be additional local requirements that fall under the NH MS4 permittee's Authorization to Discharge Permit for those regulated areas.
- f. Appendix F of the CGP contains information regarding Tier 2, or high quality waters in the various states. **[EPA notes that this information has now been moved to <https://www.epa.gov/npdes/construction-general-permit-resources-tools-and-templates>]** Although there is no official list of tier 2 waters for New Hampshire, it can be assumed that all New Hampshire surface waters are tier 2 for turbidity unless 1) the surface water that you are proposing to discharge into is listed as impaired for turbidity in the states listing of impaired waters (see <https://nhdes-surface-water-quality-assessment-site-nhdes.hub.arcgis.com/>) or 2) sampling upstream of the proposed discharge location shows turbidity values greater than 10 NTU (Env-Wq 1703.11). A single grab sample collected during dry weather (no precipitation within 48 hours) is acceptable.
- g. To ensure compliance with RSA 485-C, RSA 485-A, RSA 485-A:13, I(a), Env-Wq 1700 and Env-Wq 302, the following information may be requested by NHDES. This information must be kept on site unless you receive a written request from NHDES that it be sent to the address shown below in 9.1.1.h.

- i. A list of all non-stormwater discharges that occur at the facility, including their source locations and the control measures being used (see Part 1.2.2 of the CGP).
 - ii. Records of sampling and analysis required for construction dewatering and stormwater discharges (see 9.1.1.d above).
- h. All required or requested documents must be sent to: NH Department of Environmental Services, Watershed Management Bureau, P.O. Box 95 Concord, NH 03302-0095.

9.1.2 MAR100000 Commonwealth of Massachusetts (except Indian country)

- a. All discharges covered by the Construction General Permit shall comply with the provisions pursuant to 314 CMR 3.00, 314 CMR 4.00, 314 CMR 9.00, including applicable construction stormwater standards and 310 CMR 10.00.
- b. Pursuant to 314 CMR 3.11 (2)(a)6., and in accordance with MassDEP's obligation under 314 CMR 4.05(5)(e) to maintain surface waters free from pollutants in concentrations or combinations that are toxic to humans, aquatic life, or wildlife, permittees are prohibited from discharging dewatering water under the CGP from sites that are designated as Superfund/CERCLA or RCRA, and must make accommodations to dispose of the dewatering discharges appropriately, such as coverage under the Remediation General Permit (RGP).
- c. Pursuant to 314 CMR 3.11 (2)(a), and in accordance with MassDEP's obligation to protect Outstanding Resource Waters under 314 CMR 4.04(3), applicants seeking coverage under the 2022 CGP that propose to carry out construction activities near Outstanding Resource Waters as identified in 314 CMR 4.06, shall submit to MassDEP for review:
 - i. a copy of the Stormwater Pollution Prevention Plan (SWPPP),
 - ii. a copy of the EPA NOI, and
 - iii. MassDEP's Stormwater BMP Checklist.

For purposes of this review, the permittee shall submit these documents to MassDEP at the same time they are submitted to EPA. Instructions on how to submit these documents to MassDEP and where to find the MassDEP Stormwater BMP Checklist and obtain authorization to discharge can be found here: <https://www.mass.gov/how-to/wm-15-npdes-general-permit-notice-of-intent>.

- d. Pursuant to 314 CMR 3.11 (2)(a)6., and in accordance with MassDEP's obligation under 314 CMR 4.05(5)(e) to maintain surface waters free from pollutants in concentrations or combinations that are toxic to humans, aquatic life, or wildlife, applicants that propose to dewater under the 2022 CGP and plan to discharge to certain waters as described below, shall determine that any dewatering discharges are not contaminated by testing the proposed discharge as described below as part of the application for WM15 authorization. Unless otherwise specified, testing described in this section should be conducted using the methods in 40 CFR 136.
 - i. Applicants for sites that plan to discharge to Outstanding Resource Waters as identified in 314 CMR 4.06 shall test one sample of the proposed dewatering discharge water for pH, E. Coli (for discharges to freshwater), fecal coliform (for

discharges to salt water), Enterococci (for discharges to salt water), total suspended solids, oil and grease, total nitrogen, total phosphorus, and all parameters with numeric criteria listed in the Massachusetts Surface Water Quality Standards at 314 CMR 4.05(e). Results shall be reported to MassDEP as part of the WM15 application. To determine if the dewatering discharge could be covered under the 2022 CGP, the effluent at zero dilution must meet numeric water quality criteria. If the effluent does not meet numeric water quality criteria, the applicant shall contact EPA Region 1 to discuss coverage under the Remediation General Permit.

- ii. Applicants for sites that propose to discharge to Public Water Supplies (314 CMR 4.06(1)(d)1) shall also test one sample of the proposed dewatering discharge water for per- and polyfluoroalkyl substances (PFAS), as outlined in the table below. Results shall be reported to MassDEP as part of the WM15 application. If any PFAS compounds are detected, the applicant shall apply for coverage under the NPDES Remediation General Permit for Massachusetts if required.

PFAS Testing Parameters for Discharges to Public Drinking Water Supplies¹⁰⁰	
Perfluorohexanesulfonic acid (PFHxS), grab	Report ng/L
Perfluoroheptanoic acid (PFHpA), grab	Report ng/L
Perfluorononanoic acid (PFNA), grab	Report ng/L
Perfluorooctanesulfonic acid (PFOS), grab	Report ng/L
Perfluorooctanoic acid (PFOA), grab	Report ng/L
Perfluorodecanoic acid (PFDA), grab	Report ng/L

- iii. Applicants for sites that propose to discharge to an impaired water as identified in the most recent final Massachusetts Integrated List of Waters, shall test one sample of the proposed dewatering discharge water for the parameter(s) for which the waterbody is impaired. To determine if the dewatering discharge could be covered under the 2022 CGP, the effluent at zero dilution must meet numeric water quality criteria. If the effluent does not meet numeric water quality criteria, the applicant shall contact EPA Region 1 to discuss coverage under the Remediation General Permit and shall apply for RGP coverage if required.
- iv. For dewatering discharges to all other waters, if any pollutants are known or believed present in the proposed dewatering discharge water, the applicant shall apply for coverage under the NPDES Remediation General Permit for Massachusetts if required. For the purposes of this condition, a pollutant is "known present" if measured above the analytical detection limit using a sufficiently sensitive test method in an environmental sample, and "believed present" if a pollutant has not been measured in an environmental sample but will be added or generated prior to discharge, such as through a treatment process. Consequently, a pollutant is "known absent" if measured as non-detect relative to the analytical detection limit using a sufficiently sensitive test method in an environmental sample, and "believed absent" if a pollutant has not been measured in an environmental sample but will not be added or generated prior to discharge and is not a parameter that applies to the applicable activity category for a site. If any pollutants are known or believed present in the

¹⁰⁰ PFAS testing shall follow established EPA methods 537 or 537.1 for drinking water until EPA Method 3512 for non-potable water becomes available.

proposed dewatering discharge water, the applicant shall test one sample of the proposed dewatering discharge water for the pollutants known or believed to be present. To determine if the dewatering discharge could be covered under the 2022 CGP, the effluent at zero dilution must meet numeric water quality criteria. If the effluent does not meet numeric water quality criteria, the applicant shall contact EPA Region 1 to discuss coverage under the Remediation General Permit.

- e.** Pursuant to 314 CMR 3.11 (2)(a), and in accordance with MassDEP's obligation to protect Outstanding Resource Waters under 314 CMR 4.04(3), applicants that propose to dewater under the 2022 CGP and discharge to Outstanding Resource Waters as identified in 314 CMR 4.06, shall submit the SWPPP and associated documents to MassDEP to review. MassDEP shall complete review within 30 days of receipt.
- f.** Pursuant to 314 CMR 3.11 (2)(a)6., and in accordance with MassDEP's obligation under 314 CMR 4.05 to maintain surface waters free from color and turbidity in concentrations or combinations that are aesthetically objectionable or would impair any use assigned to the waterbody, permittees that have been authorized to dewater under the 2022 CGP and that discharge to Outstanding Resource Waters as identified in 314 CMR 4.06 shall carry out daily benchmark monitoring for turbidity¹⁰¹ for the duration of dewatering. Permittees shall compare the weekly average of the turbidity monitoring results with the established benchmark turbidity value of 25 Nephelometric Turbidity Units (NTU). If a permittee's weekly average turbidity results exceed the benchmark, the operator shall conduct follow-up corrective action to determine the source of the problem and to make any necessary repairs or upgrades to the dewatering controls to lower the turbidity levels. The permittee shall document any corrective action taken in its corrective action log. Furthermore, permittees at these sites shall carry out inspections at higher frequency, specifically, daily inspections of the dewatering discharge treatment for the duration of the discharge. The permittee shall inspect the site for sediment plume or whether a hydrocarbon sheen is visible at the point of discharge, estimate the flow rate at the point of discharge, and inspect the site downstream to assess whether sedimentation is attributable to the dewatering discharges.
- g.** Pursuant to 314 CMR 3.11 (2)(a)6., and in accordance with MassDEP's obligation under 314 CMR 4.05 to maintain surface waters free from color and turbidity in concentrations or combinations that are aesthetically objectionable or would impair any use assigned to the waterbody, permittees shall store materials outside the Base Flood Elevation¹⁰² when feasible to prevent displacing runoff and erosion.
- h.** Pursuant to 314 CMR 3.11 (2)(a), and in accordance with MassDEP's obligation to maintain surface waters free from nutrients in concentrations that would cause or contribute to impairment of existing or designated uses under 314 CMR 4.05(5)(c), all applicants who apply for coverage under the 2022 CGP shall follow guidelines on fertilizer application, including use of fertilizer containing no phosphorus, in accordance with 330 CMR 31.00 Plant Nutrient Application Requirements for

¹⁰¹ Applicants shall follow EPA Method 180.1 to monitor for turbidity

¹⁰² Base Flood Elevation (BFE) is the elevation of surface water resulting from a flood that has a 1% chance of equaling or exceeding that level in any given year. The BFE is shown on the Flood Insurance Rate Map (FIRM) for zones AE, AH, A1-A30, AR, AR/A, AR/AE, AR/A1-A30, AR/AH, AR/AO, V1-V30 and VE. (Source: <https://www.fema.gov/node/404233>).

Agricultural Land and Non-Agricultural Turf and Lawns. Further, fertilizer shall never be applied to a site when a rain event greater than 0.5 inches is forecast in the next 48 hours.

- i. Pursuant to 314 CMR 3.11 (2)(a), all applicants who apply for coverage under the 2022 CGP and elect to carry out site inspections every 14 days shall also inspect sites within 24 hours of 0.25 inches of precipitation events or greater over 24 hours, or within 24 hours of a discharge that occurred due to snowmelt from 3.25 inches or greater of snow accumulation.¹⁰³ During the high flow periods in spring (i.e., months of April to June), inspection frequency shall be increased to once per week for all sites.
 - i. To determine whether 3.25 inches or greater of snow accumulation has occurred at a site, snowfall measurements can be taken at the site,¹⁰⁴ or the operator can rely on similar information from a local weather forecast.
- j. Implementing structural improvements, enhanced/resilient pollution prevention measures, and other mitigation measures can help to minimize impacts from stormwater discharges from major storm events such as hurricanes, storm surge, extreme/heavy precipitation,¹⁰⁵ and flood events. Pursuant to 314 CMR 3.11 (2)(a), if such stormwater control measures are already in place due to existing requirements mandated by other state, local or federal agencies, the SWPPP shall include a brief description of the controls and a reference to the existing requirement(s). If the site may be exposed to or has previously experienced such major storm events¹⁰⁶, additional stormwater control measures that may be considered, and implemented as necessary, include, but are not limited to:
 - i. Reinforce materials storage structures to withstand flooding and additional exertion of force;
 - ii. Prevent floating of semi-stationary structures by elevating to the Base Flood Elevation (BFE) level or securing with non-corrosive device;
 - iii. When a delivery of exposed materials is expected, and a storm is anticipated within 48 hours, delay delivery until after the storm or store materials as appropriate (refer to emergency procedures);

¹⁰³ This is the amount of snow that is equivalent to 0.25 inches of rain, based on information from the National Oceanic and Atmospheric Administration (NOAA) indicating that 13 inches of snow is, on average, equivalent to 1 inch of rain. See <https://www.nssl.noaa.gov/education/svrwx101/winter/faq/>.

¹⁰⁴ NOAA's National Weather Service has guidelines on snowfall measurements at https://www.weather.gov/jkl/snow_measurement. These guidelines recommend use of a "snowboard" (a piece of wood about 16 inches by 16 inches) that is placed in an unobstructed part of the site on a hard surface.

¹⁰⁵ Heavy precipitation refers to instances during which the amount of rain or snow experienced in a location substantially exceeds what is normal. What constitutes a period of heavy precipitation varies according to location and season. Heavy precipitation does not necessarily mean the total amount of precipitation at a location has increased—just that precipitation is occurring in more intense or more frequent events.

¹⁰⁶ To determine if your facility is susceptible to an increased frequency of major storm events that could impact the discharge of pollutants in stormwater, you may reference FEMA, NOAA, or USGS flood map products at https://www.usgs.gov/faqs/where-can-i-find-flood-maps?qt-news_science_products=0#qt-news_science_products.

- iv. Temporarily store materials and waste above the Base Flood Elevation **[EPA notes that it has deleted a footnote reference to the term "Base Flood Elevation" since the same footnote is already included in Part 9.1.2.g, above.]** level;
 - v. Temporarily reduce or eliminate outdoor storage;
 - vi. Temporarily relocate any mobile vehicles and equipment to higher ground;
 - vii. Develop scenario-based emergency procedures for major storms that are complementary to regular stormwater pollution prevention planning and identify emergency contacts for staff and contractors; and
 - viii. Conduct staff training for implementing your emergency procedures at regular intervals.
- k. Pursuant to 314 CMR 3.11 (2)(a)6., and in accordance with MassDEP's obligation under 314 CMR 4.05(5)(e) to maintain surface waters free from pollutants in concentrations or combinations that are toxic to humans, aquatic life, or wildlife, permittees who seek coverage under the 2022 CGP and anticipate to carry out dust control shall limit their dust control methodology to using water only and specifically avoid using other techniques, such as solutions containing calcium chloride.
- l. If MassDEP requests a copy of the Stormwater Pollution Prevention Plan (SWPPP) for any construction site at any time, the permittee shall submit the SWPPP to MassDEP within 14 days of such a request. MassDEP may conduct an inspection of any site covered by this permit to ensure compliance with state law requirements, including state water quality standards.

9.1.3 MTR10F000 Areas in the State of Vermont located at a federal facility

- a. Earth disturbance at any one time is limited to five acres.
- b. All areas of earth disturbance must have temporary or final stabilization within 14 days of the initial disturbance. After this time, disturbed areas must be temporarily or permanently stabilized in advance of any runoff producing event. A runoff producing event is an event that produces runoff from the construction site. Temporary stabilization is not required if precipitation is not forecast and work is to continue in the next 24-hours or if the work is occurring in a self-contained excavation (i.e. no outlet) with a depth of two feet or greater (e.g. house foundation excavation, utility trenches). Areas of a construction site that drain to sediment basins are not considered eligible for this exemption, and the exemption applies only to the excavated area itself.
- c. Site inspections on active construction sites shall be conducted daily during the period from October 15 through April 15.
- d. The use of chemical treatments (e.g. polymers, flocculants, and coagulants) for the settling and/or removal of sediment from stormwater runoff associated with construction and construction-related activities requires prior written approval and an approved site and project-specific plan, from the Vermont Agency of Natural Resources. In addition, the use of cationic polymers is prohibited unless approved by the Vermont Agency of Natural Resources under a site and project-specific plan.
- e. Any applicant under EPA's CGP shall allow authorized Vermont Agency of Natural Resources representatives, at reasonable times and upon presentation of credentials, to enter upon the project site for purposes of inspecting the project and determining

compliance with this Certification.

- f. The Vermont Agency of Natural Resources may reopen and alter or amend the conditions of this Certification over the life of the EPA 2022 Construction General Permit when such action is necessary to assure compliance with the VWQS.

9.2 EPA REGION 2

9.2.1 NYR10I000 Indian country within the State of New York

a. Saint Regis Mohawk Tribe

- i. Any Responsible-Person/Decision-Maker required under the CGP to submit a Notice of Intent (NOI) to EPA for coverage under the CGP, must concurrently submit an electronic copy of the NOI to the SRMT Environmental Division, Water Resource Program Manager. Additionally, an electronic copy of the Notice of Termination (NOT) must be provided within three business days after electronic confirmation is received from EPA that the NOT has been accepted. The NOI and NOT must be electronically provided to the following addresses:

Mr. Tieman W. Smith

Water Resources Program Manager Saint Regis Mohawk Tribe

449 Frogtown Road

Akwesasne, NY 13655 Tiernan.Smith@srmt-nsn.gov 518.358.2272 ext. 5073

- ii. Any Responsible-Person/Decision-Maker that is required as part of the CGP to prepare a Discharge Management Plan (OMP) or Storm Water Management Plan (SWMP) and/or Storm Water Pollution Prevention Plan (SWPPP) must submit an electronic copy of the DMP, SWMP and/or SWPPP to the SRMT Environment Division, Water Resources Program Manager IO business days prior to the start of construction of any work to be conducted under the CGP. The applicable documents must be provided to the electronic address listed above.
- iii. Any Responsible-Person/Decision-Maker that is required under the CGP to submit an annual report to EPA must submit an electronic copy of the annual report concurrently to the SRMT Water Resource Program. Additionally, any correspondences between the applicant and EPA related to analytical data, written reports, corrective action, enforcement, monitoring, or an adverse incident must likewise be routed to the SRMT Water Resources Program at the above electronic address.
- iv. An "Authorization to Proceed Letter" with site-specific mitigation requirements may be sent out to the permittee when a review of the NOI and OMP, SWMP and /or SWPPP on a case-by-case basis, is completed by the SRMT Environment Division, Water Resource Program. This approval will allow the application to proceed if all mitigation requirements are met.

b. Seneca Nation

- i. Under Part 1.1.5 of the CGP, the Seneca Nation requests that an applicant must demonstrate that they meet the eligibility criteria listed in Appendix D (certify in your Notice of Intent (NOI) that you meet one of the eligibility criteria [Criterion A-F]) as well as species and critical habitats that are listed under the Seneca Nation's "Fishing and Conservation Laws" and the "Seneca Nation of Indians Comprehensive Conservation Law".

- ii. The Tribal Historic Preservation Office (THPO) was established in 2000 after the Seneca Nation received a recognition letter from the National Park Service (NPS); therefore under Part 1.1.6 of the CGP (Appendix E) and prior to submitting a Notice of Intent (NOI) operators must complete the Nation's THPO, Project Review Form (<https://sni.org/media/246603/sni-thpo-project-review-form.pdf>) and submit the completed form with associated information to the Tribal Historic Preservation Officer at 90 Ohi:yo' Way, Salamanca, NY 14779. Federal agencies engaging in construction activities must provide for construction review by a certified construction reviewer in accordance with 7 Del. C. §§4010 & 4013 and 7 DE Admin. Code 5101, subsection 6.1.6.
- iii. Under Part 1.2 of the CGP, discharges must also follow the Section 13 of the Guide for Construction (Seneca Nation of Indians Source Water Code) and respectively, Council Resolution, dated April 13, 2013 (CN: R-04-13-13-11) to ensure that the health, safety and welfare of the citizens of the Seneca Nation, and all other within the Lands and Territories of the Seneca Nation of Indians, and to facilitate the adequate provisions of water through the elimination or prevention of ground water contamination in the vicinity of wells that supply drinking water for the Nation. The area is known as the Source Water Protection Area (SWPA) and specified activities are regulated within this SWPA, as cited in Section 13 of the Guide for Construction and Section VI, of CN: R-04-13-13-11.
- iv. Under Part 1.4, any operator who seeks coverage of the CGP, and is required to submit a notice of intent NOI and Notice of Termination (NOT) (as necessary) to the EPA for coverage, under Part 1.4.2 must also submit a copy of the NOI to the Seneca Nation's Environmental Protection Department (EPD) within three business days of submittal to the EPA, (address shown below). Respectively, a copy of the NOT (as described under Part 8.3 of the CGP), which certifies that you have met the requirements of Part 8, must be provided within three business days after electronic confirmation is received from the EPA that the NOT has been accepted. In addition to a NOI and NOT, the Seneca Nation (Environmental Protection Department [EPD]) would require an Environmental Impact Assessment (EA) (Long Form), as shown in Section 2 of the Seneca Nation of Indians Laws, Ordinances & Policies (Guide for Construction), to be completed and submitted to the EPD prior to any project to determine whether the impacts from a project would create significant and detrimental effects to the Nation's lands, water (violate WQS), and environment. The NOI, NOT, and EA must be submitted electronically to epd@sni.org and provided to the following address:
Seneca Nation
Environmental Protection Department (EPD) Attn: Director of EPD
12837 Route 438
Irving, NY 14081
- v. Under Part 3.0 of the CGP, discharges must be controlled as necessary to meet applicable WQS. The Seneca Nation is working actively towards finalizing and implementing the; therefore, the EPD would require an applicant to submit or grant access to the permit to obtain information on the impact of effluents on receiving waters, including the capability of receiving waters to support future designated uses and achieve the WQS of the Nation; and to advise prospective dischargers of discharge requirements, and coordinate with the appropriate

permitting agencies. As stated in the Decision Document, under Section 303(c) of the CWA, 33 U.S.C. § 1313(c), states develop, review, and revise (as appropriate) water quality standards for surface waters of the United States. At a minimum, such standards are to include designated water uses, water quality criteria to protect such uses, and an antidegradation policy. 40 C.F.R. § 131.6. In addition, under Section 401 of the CWA states may grant, condition, or deny "certification" for federally permitted or licensed activities that may result in a discharge to the waters of the United States 33 U.S.C. § 1341.

- vi. Under Part 7.2.8(a)(b)(c) and for Part 9 of the CGP, the following Sections of the Seneca Nation's Guide for Construction shall be considered, in conjunction with the CGP:
 - (a) Section 1. Executive Order - To Establish a Policy for Governing Access to Nation Territories and Facilities by Officials of Foreign Government, dated March 31, 2011
 - (b) Section 3. Natural Resources Committee, Sand and Gravel Law (CN: R-06-24-05-08)
 - (c) Section 4. Fishing and Conservation Laws - Part 1.1.5 of the CGP
 - (d) Section 5. Seneca Nation of Indians Comprehensive Conservation Law, adopted January 14, 2012
 - (e) Section 9. Food is Our Medicine (FIOM) Program/Native Planting Policy (CN: R-03-08-14-14)
 - (f) Section 10. Forestry Management Plan (CN: R-08-14-10-23)
 - (g) Section 11. Timber Ordinance #411-092, dated May 8, 1982
 - (h) Section 14. Flood Damage Prevention Local Law, dated September 27, 1988
 - (i) Section 16. Utilities Ordinance No. 87-100
 - (j) Authorizing Emergency Action and Contingency Plan to Restrain Pollution of Nations Waters, (Council Resolution: R-03-01-18-10), dated March 10, 2018
Seneca Nation of Indians Permit Application for Construction within Waterways Permit, Form NR98-01.00

9.3 EPA REGION 3

9.3.1 DCR100000 District of Columbia

- a. Discharges authorized by this permit shall comply with the District of Columbia Water Pollution Control Act of 1984, as amended (DC Official Code § 8-103.01 and § 8-103.06, et seq.) to ensure that District of Columbia waters, waters in adjacent and downstream states, and the beneficial uses of these waters will not be harmed or degraded by the discharges.
- b. Discharges authorized by this permit must comply with §§ 1104.1 and 1104.8 of Chapter 11 and the provisions of Chapter 19 of Title 21 of District of Columbia Municipal Regulations in order to attain and maintain designated uses of the District of Columbia waters.

- c. The permittee shall comply with the District of Columbia Stormwater Management and Soil Erosion and Sediment Control regulations in Chapter 5 of Title 21 of the District of Columbia Municipal Regulations.
- d. The permittee shall comply with the District of Columbia Flood Management Control regulations in Chapter 31 of Title 20 of the District of Columbia Municipal Regulations.
- e. The permittee shall submit a copy of the Stormwater Pollution Prevention Plan (SWPPP) to the Regulatory Review Division, Department of Energy & Environment, Government of the District of Columbia, 1200 First Street, NE, 5th Floor, Washington, DC 20002, during the review and approval of the permittee's DOEE Erosion and Sediment Control Plan in accordance with the provisions of Chapter 542 of Title 21 of the District of Columbia Municipal Regulations.
- f. Upon request, the permittee shall submit all inspection and monitoring reports as required by this permit and 40 CFR § 122.41 to the Associate Director, Inspection and Enforcement Division, Department of Energy & Environment, Government of the District of Columbia, 1200 First Street, NE, 5th Floor, Washington, DC 20002; telephone (202) 535-2226, or by email at Joshua.Rodriguez@dc.gov.
- g. In the event the permittee intends to discharge dewatering water, groundwater, or groundwater comingled with stormwater from a known contaminated site, the permittee shall contact the Regulatory Review Division, Department of Energy & Environment, Government of the District of Columbia, 1200 First Street, NE, 5th Floor, Washington, DC 20002; telephone (202) 535-2600, or by email at MS4DischargeAuthorization@dc.gov to request authorization to discharge dewatering water, groundwater, or groundwater comingled with stormwater to the District's Municipal Separate Storm Sewer System (MS4) or to a surface water body pursuant to §§ 8-103.02, 8-103.06, and 8-103.07 of the District of Columbia Water Pollution Control Act of 1984, as amended.

9.3.2 DER10F000 Areas in the State of Delaware located at a federal facility (as defined in Appendix A)

- a. Federal agencies must submit a sediment and stormwater management plan (SSMP) and receive Department approval prior to undertaking any land clearing, soil movement or construction activity unless conducting an exempt activity.
- b. Federal construction activities are required to have a third-party Certified Construction Reviewer (CCR) perform weekly reviews to ensure the adequacy of construction activities pursuant to the approved SSMP and regulations. Implementation of approved SSMPs requires the daily oversight of construction activity by certified responsible personnel.
- c. Implementation of approved SSMPs requires the daily oversight of construction activity by certified responsible personnel.
- d. A current copy of the SSMP must be maintained at the construction site.
- e. Unless authorized by the Department, not more than 20 acres may be disturbed at any one time.

9.4 EPA REGION 4

No additional conditions

9.5 EPA REGION 5**9.5.1 MIR10I000 Indian country within the State of Minnesota****a. Fond du Lac Reservation**

- i.** New dischargers wishing to discharge to an Outstanding Reservation Resource Water (ORRW)¹⁰⁷ must obtain an individual permit from EPA for storm water discharges from large and small construction activities.
- ii.** A copy of the Storm Water Pollution Prevention Plan (SWPPP) must be submitted to the Office of Water Protection at least fifteen (15) days in advance of sending the Notice of Intent to EPA. The SWPPP can be submitted electronically to richardgitar@FDLREZ.com or by hardcopy sent to:
Fond du Lac Reservation
Office of Water Protection
1720 Big Lake Road
Cloquet, MN 55720
- iii.** Copies of the Notice of Intent (NOI) and the Notice of Termination (NOT) must be sent to the Fond du Lac Office of Water Protection at the same time they are submitted to EPA. [The condition helps the Office of Water Protection keep track of when a project is about to start and when it has ended. FDL Water Quality Certification Ordinance, Section 204 (a) (2)].
- iv.** If the project will entail a discharge to any watercourse or open water body, the turbidity limit shall NOT exceed 10% of natural background within the receiving water(s) as determined by Office of Water Protection staff. For such discharges, turbidity sampling must take place within 24 hours of a ½-inch or greater rainfall event. The results of the sampling must be reported to the Office of Water Protection within 7 days of the sample collection. All sample reporting must include the date and time, location (GPS: UTM/Zone 15), and NTU. CGP applicants are encouraged to work with the Office of Water Protection in determining the most appropriate location(s) for sampling. [This condition helps both the Office of Water Protection and the project proponent in knowing whether or not their erosion control efforts are effective. FDL Water Quality Certification, Section 204 (b) (1)].
- v.** Receiving waters with open water must be sampled for turbidity prior to any authorized discharge as determined by Office of Water Protection staff. This requirement only applies to receiving waters which no ambient turbidity data exists. [This condition allows the Office of Water Protection to obtain a baseline turbidity sample in which to compare to other samples. FDL Water Quality Certification Ordinance, Section 204 (b) (2)].
- vi.** All work shall be carried out in such a manner as will prevent violations of water quality criteria as stated in the Water Quality Standards of the Fond du Lac Reservation, Ordinance #12/98, as amended. This includes, but is not limited to, the prevention of any discharge that causes a condition in which visible solids, bottom deposits, or turbidity impairs the usefulness of water of the Fond du Lac

¹⁰⁷ Although additional waters may be designated in the future, currently Perch Lake, Rice Portage Lake, Miller Lake, Deadfish Lake, and Jaskari Lake are designated as ORRWs.

Reservation for any of the uses designated in the Water Quality Standards of the Fond du Lac Reservation. These uses include wildlife, aquatic life, warm water fisheries, cold water fisheries, subsistence fishing (netting), primary contact recreation, secondary contact recreation, cultural, wild rice areas, aesthetic waters, agriculture, navigation, commercial and wetlands. It also includes the designated uses of wetlands including, but not limited to, baseflow discharge, cultural opportunities, flood flow attenuation, groundwater recharge, indigenous floral and fauna) diversity and abundance, nutrient cycling, organic carbon export/cycling, protection of downstream water quality, recreation, resilience against climactic effects, sediment/shoreline stabilization, surface water storage, wild rice, and water dependent wildlife. [In addition to listing the designated uses of waters of the Fond du Lac Reservation, this condition also limits the project proponent to discharges that will not violate our Water Quality Standards. FDL Water Quality Certification Ordinance, Section 204 (a) (7)).

- vii.** Appropriate steps shall be taken to ensure that petroleum products or other chemical pollutants are prevented from entering waters of the Fond du Lac Reservation. All spills must be reported to the appropriate emergency management Agency (National Response Center AND the State Duty Officer), and measures shall be taken immediately to prevent the pollution of waters of the Fond du Lac Reservation, including groundwater. The Fond du Lac Office of Water Protection must also be notified immediately of any spill regardless of size. [This condition helps protect water quality and also reminds project proponents of their responsibility in reporting spill events. FDL Water Quality Certification Ordinance, Section 204 (b) (3)).
- viii.** All seed mixes, whether used for temporary stabilization or permanent seeding, shall NOT contain any annual ryegrass (*Lolium* species). Wild rye (*Elymus* species) or Oats (*Avena* species) may be used as a replacement in seed mixes. [This condition prevents the use of annual ryegrass on the Reservation. Annual ryegrass is allelopathic, which means it produces biochemical in its roots that inhibit the growth of native plants. If used in seed mixes, annual ryegrass could contribute to erosion, especially on slopes. However, the condition also specifies substitute grasses that germinate almost as fast as annual ryegrass for use as a cover crop to help prevent erosion. FDL Water Quality Certification Ordinance, Section 204 (t) (1)).
- ix.** To prevent the introduction of invasive species, ALL contractors and subcontractors MUST disclose information stating prior equipment location(s) and ALL known invasive species potentially being transported from said location(s). All equipment MUST undergo a high pressure wash (including any equipment mats) BEFORE ENTERING the Fond du Lac Reservation. Personal equipment such as work boots, gloves, vest, etc. MUST be clean of debris, dirt and plant and animal material BEFORE ENTERING the Fond du Lac Reservation. Equipment being transported from known infested areas MUST undergo a high pressure wash as soon as possible after leaving the infested site and again BEFORE ENTERING the Fond du Lac Reservation, to avoid transport of invasive species into areas surrounding the Reservation. Written certification of equipment cleaning MUST be provided to the Fond du Lac Office of Water Protection. Upon arrival, ALL contractor and subcontractor equipment will be inspected by appointed Fond du Lac staff. If equipment is deemed unsatisfactory, the equipment MUST

undergo a high pressure washing until the equipment is cleared by the inspector, until such time, minimal travel will be allowed through the Reservation. The contractor shall be held responsible for the control of any invasive species introduced as a result of their project. [This condition requires the project proponent to prevent the inadvertent introduction of invasive species by taking an active role in cleaning all vehicles, equipment, and equipment mats before entering the Reservation. This condition has been placed in certifications since 2012, due to the introduction of Wild Parsnip in 2011 from a pipeline contractor. It is much easier to prevent the introduction of an invasive species than it is to eradicate it once it has been introduced. Many invasive plant species form monocultures, preventing native plants from growing. This situation often leads to cases of erosion, which in turn effects water quality. FOL Water Quality Certification Ordinance, Section 204 (g) (1)].

- x. A copy of this certification MUST be kept by the contractor on-site at all times and be available for viewing by all personnel, including inspectors. [This condition ensures that the information contained in the certification, especially the conditions, is readily available onsite for reference. FOL Water Quality Certification Ordinance, Section 204 (a) (9)].

b. The Grand Portage Band of Lake Superior Chippewa

- i. The CGP authorization is for construction activities that may occur within the exterior boundaries of the Grand Portage Reservation in accordance to the Grand Portage Land Use Ordinance. The CGP regulates stormwater discharges associated with construction sites of one acre or more in size. Only those activities specifically authorized by the CGP are authorized by this certification (the "Certification").
- ii. All construction stormwater discharges authorized by the CGP must comply with the Water Quality Standards and Water Resources Ordinance, as well as Applicable Federal Standards (as defined in the Water Resources Ordinance).
- iii. All appropriate steps must be taken to ensure that petroleum products or other chemical pollutants are prevented from entering the Waters of the Reservation. All spills must be reported to the appropriate emergency-management agency, and measures must be taken to prevent the pollution of the Waters of the Reservation, including groundwater.
- iv. The 2022 CGP requires inspections and monitoring reports of the construction site stormwater discharges by a qualified person. Monitoring and inspection reports must comply with the minimum requirements contained in the 2022 CGP. The monitoring plan must be prepared and incorporated into the Storm Water Pollution Prevention Plan (the "SWPP"). A copy of the SWPP must be submitted to the Board at least 30 days in advance of sending the requisite Notice of Intent to EPA. The SWPP should be sent to:

Grand Portage Environmental Resources Board
P.O. Box 428
Grand Portage, MN 55605

Copies of the Notice of Intent and Notice of Termination required under the General Permit must be submitted to the Board at the address above at the same time they are submitted to the EPA.

- v. If requested by the Grand Portage Environmental Department, the permittee must provide additional information necessary for a case-by-case eligibility determination to assure compliance with the Water Quality Standards and any Applicable Federal Standards. The burden is on the applicant to demonstrate compliance with the Water Quality Standards, the Water Resources Ordinance, and Applicable Federal Standards whether or not the application is ultimately eligible for the CGP.
 - vi. CGP discharges must not cause nuisance conditions as defined in Grand Portage Water Quality Standards.
 - vii. The Board retains full authority to ensure compliance with and to enforce the provisions of the Water Resource Ordinance and Water Quality Standards, Applicable Federal Standards, and these Certification conditions. Nothing herein affects the scope or applicability of other controlling tribal or federal requirements, including but not limited to impacts to cultural, historical, or archeological features or sites, or properties that may be eligible for listing on the National Register of Historic Places under the National Historic Preservation Act, 54 U.S.C. §§ 300101 et seq.
 - viii. Appeals related to Board actions taken in accordance with any of the preceding conditions may be heard by the Grand Portage Tribal Court.
- c. Leech Lake Band of Ojibwe**
- i. The water quality standards that apply to the construction site are the standards at the time the operator submits its Notice of Intent (NOI) to EPA and the LLBO WRP (see conditions # 2 and # 3).
 - ii. A copy of the Stormwater Pollution Prevention Plan (SWPPP) must be submitted to the LLBO WRP at least 30 days in advance of sending the NOI for the project to EPA. See attached LLBO 401 Water Quality Certification Ordinance. Section 304(a)(1). The SWPPP should be submitted electronically to Jeff.Harper@llojibwe.net and by hardcopy sent to:
Leech Lake Band of Ojibwe
ATTN: Water Resources Program - 401 Cert
Division of Resource Management
190 Sailstar Drive NW
Cass Lake, Minnesota 56633
 - iii. Copies of the NOI and the Notice of Termination (NOT) must be submitted to the LLBO WRP at the same time they are submitted to EPA. See attached LLBO 401 Water Quality Certification Ordinance, Section 304(a)(2). The NOI and NOT should be submitted electronically to Jeff.Harper@llojibwe.net and sent by hardcopy to the address cited in condition # 2.
 - iv. Any and all other conditions listed in Section 304 of the attached LLBO 401 Water Quality Certification Ordinance shall be observed unless the LLBO WRP deems that certain conditions therein are not applicable to the project in need of a permit under this certification.
 - v. A copy of this certification MUST be kept by the contractor on-site at all times and be available for viewing by all personnel, including inspectors.
 - vi. Upon consideration of the NOI, if the LLBO WRP finds that the discharge will not be controlled as necessary to meet applicable water quality standards, the LLBO

WRP may insist, consistent with Part 3.1 of the CGP, that additional controls are installed to meet applicable water quality standards, or recommend to EPA that the operator obtain coverage under an individual permit.

9.5.2 WIR10I000 Indian country within the State of Wisconsin

a. Bad River Band of Lake Superior Tribe of Chippewa Indians

- i. Only those activities specifically authorized by the CGP are authorized by this Certification. This Certification does not authorize impacts to cultural properties, or historical sites, or properties that may be eligible for listing as such.
- ii. All projects which are eligible for coverage under the CGP and are located within the exterior boundaries of the Bad River Reservation shall be implemented in such a manner that is consistent with the Tribe's Water Quality Standards (WQS). The Tribe's WQS can be viewed at: http://www.badriver-nsn.gov/wp-content/uploads/2020/01/NRD_WaterQualityStandards_2011.pdf
- iii. Operators are not eligible to obtain authorization under the CGP for all new discharges to an Outstanding Tribal Resource Water (OTRW or Tier 3 water). OTRWs, or Tier 3 waters, include the following: Kakagon Slough and the lower wetland reaches of its tributaries that support wild rice, Kakagon River, Bad River Slough, Honest John Lake, Bog Lake, a portion of Bad River, from where it enters the Reservation through the confluence with the White River, and Potato River. OTRWs can be viewed at:
<https://www.arcgis.com/apps/View/index.html?appid=6f44c371217e4ee8b5f1c2c705c7c7c5>
- iv. An operator proposing to discharge to an Outstanding Resource Water (ORW or Tier 2.5 water) under the CGP must comply with the antidegradation provisions of the Tribe's WQS. ORWs, or Tier 2.5 waters, include the following: a portion of Bad River, from downstream the confluence with the White River to Lake Superior, White River, Marengo River, Graveyard Creek, Bear Trap Creek, Wood Creek, Brunsweller River, Tyler Forks, Bell Creek, and Vaughn Creek. ORWs can be viewed at:
<https://www.arcgis.com/apps/View/index.html?appid=6f44c371217e4ee8b5f1c2c705c7c7c5>. The antidegradation demonstration materials described in provision E.4.iii., and included on the antidegradation demonstration template found at: <https://www.badriver-nsn.gov/natural-resources/projectreviews/>, must be submitted to the following address:
Bad River Tribe's Natural Resources Department
Attn: Water Regulatory Specialist
P.O. Box 39 Odanah, WI 54861
WaterReg@badriver-nsn.gov
- v. An operator proposing to discharge to an Exceptional Resource Water (ERW or Tier 2 water) under the CGP must comply with the antidegradation provisions of the Tribe's WQS. ERWs, or Tier 2 waters, include the following: any surface water within the exterior boundaries of the Reservation that is not specifically classified as an Outstanding Resource Water (Tier 2.5 water) or an Outstanding Tribal Resource Water (Tier 3 water). ERWs can be viewed at:
<https://www.arcgis.com/apps/View/index.html?appid=6f44c371217e4ee8b5f1c2c705c7c7c5>. The antidegradation demonstration materials described in provision

E.4.ii., and included on the antidegradation demonstration template found at: <https://www.badriver-nsn.gov/natural-resources/projectreviews/>, must be submitted to the following address:

Bad River Tribe's Natural Resources Department
Attn: Water Regulatory Specialist
P.O. Box 39 Odanah, WI 54861
WaterReg@badriver-nsn.gov

- vi.** Projects utilizing cationic treatment chemicals within the Bad River Reservation boundaries are not eligible for coverage under the CGP.
- vii.** A discharge to a surface water within the Bad River Reservation boundaries shall not cause or contribute to an exceedance of the turbidity criterion included in the Tribe's WQS, which states: Turbidity shall not exceed 5 NTU over natural background turbidity when the background turbidity is 50 NTU or less, or turbidity shall not increase more than 10% when the background turbidity is more than 50 NTU.
- viii.** All projects which are eligible for coverage under the CGP within the exterior boundaries of the Bad River Reservation must comply with the Bad River Reservation Wetland and Watercourse Protection Ordinance, or Chapter 323 of the Bad River Tribal Ordinances, including the erosion and sedimentation control, natural buffer, and stabilization requirements. Questions regarding Chapter 323 and requests for permit applications can be directed to the Wetlands Specialist in the Tribe's Natural Resources Department at (715) 682-7123 or wetlands@badriver-nsn.gov.
- ix.** An operator of a project, which is eligible for coverage under the CGP, that would result in an allowable discharge under the CGP occurring within the exterior boundaries of the Bad River Reservation must notify the Tribe prior to the commencing earth-disturbing activities. The operator must submit a copy of the Notice of Intent (NOI) to the following addresses at the same time it is submitted to the U.S. EPA:

Bad River Tribe's Natural Resources Department
Attn: Water Regulatory Specialist
P.O. Box 39 Odanah, WI 54861
WaterReg@badriver-nsn.gov

Bad River Tribe's Natural Resources Department
Attn: Tribal Historic Preservation Officer (THPO)
P.O. Box 39 Odanah, WI 54861
THPO@badriver-nsn.gov

The operator must also submit a copy of the Notice of Termination (NOT) to the above addresses at the same time it is submitted to the U.S. EPA. Photographs showing the current site conditions must be included as part of the NOT to document the stabilization requirements have been met.

- x.** The THPO must be provided 30 days to comment on the project.
- xi.** The operator must obtain THPO concurrence in writing. This written concurrence will outline measures to be taken to prevent or mitigate effects to historic

properties. For more information regarding the specifics of the cultural resources process, see 36 CFR Part 800. A best practice for an operator is to consult with the THPO during the planning stages of an undertaking.

- xii.** An operator of a project, which is eligible for coverage under the CGP, that would result in an allowable discharge under the CGP occurring within the exterior boundaries of the Bad River Reservation must submit a copy of the Stormwater Pollution Prevention Plan (SWPPP) to the following address at the same time as submitting the NOI:

 - Bad River Tribe's Natural Resources Department
 - Attn: Water Regulatory Specialist
 - P.O. Box 39 Odanah, WI 54861
 - WaterReg@badriver-nsn.gov
- xiii.** Any corrective action reports that are required under the CGP must be submitted to the following address within one (1) working day of the report completion:

 - Bad River Tribe's Natural Resources Department
 - P.O. Box 39 Odanah, WI 54861
 - WaterReg@badriver-nsn.gov
- xiv.** An operator of a project, which is eligible for coverage under the CGP, that would result in an allowable discharge under the CGP occurring within the exterior boundaries of the Bad River Reservation must submit a copies of the inspection reports (including photographs) to the following address within 24 hours of completing any site inspection required:

 - Bad River Tribe's Natural Resources Department Attn: Water Regulatory Specialist
 - P.O. Box 39 Odanah, WI 54861
 - WaterReg@badriver-nsn.gov
- xv.** An operator shall be responsible for meeting any additional permit requirements imposed by the U.S. EPA necessary to comply with the Tribe's antidegradation policies if the discharge point is located upstream of waters designated by the Tribe.

9.6 EPA REGION 6

9.6.1 NMR100000 State of New Mexico, except Indian country

- a.** In Outstanding National Resource Waters (ONRWs) in New Mexico, no degradation is permitted except in limited, specifically defined instances. Therefore, Operators are not eligible to obtain authorization under this general permit for stormwater discharges to waters classified as ONRWs listed in Paragraph D of 20.6.4.9 New Mexico Administrative Code (NMAC), also referred to as "Tier 3 waters" as defined in Appendix A of this permit. Exception: When construction activities are in response to a public emergency (e.g., wildfire, extreme flooding, etc.) and the related work requires immediate authorization to avoid a threat to public health or safety.

 - i.** Operators who conduct construction activities in response to a public emergency to mitigate an immediate threat to public health or safety shall adhere to the requirements in 20.6.4.8(A)(3)(c) NMAC, including notifying the New Mexico Environment Department (NMED) within seven days of initiation of

Source of Potential Contamination or Pollutants*	Constituents likely to be required for testing*
Within 0.5 mile of an open Leaking Underground Storage Tank (LUST) site	BTEX (Benzene, Toluene, Ethylbenzene, and Xylene) plus additional parameters depending on site conditions**
Within 0.5 mile of an open Voluntary Remediation site	All applicable parameters or pollutants listed in 20.6.4.13, 20.6.4.52, 20.6.4.54, 20.6.4.97 thru 20.6.4.99, 20.6.4.101 through 20.6.4.899, and 20.6.4.900 NMAC (or an alternate list approved by the NMED-SWQB)*
Within 0.5 mile of an open RCRA Corrective Action Site	
Within 0.5 mile of an open Abatement Site	
Within 0.5 mile of an open Brownfield Site	
Within 1.0 mile or more of a Superfund site or National Priorities List (NPL) site with associated groundwater contamination.	
Construction activity contaminants and/or natural water pollutants	Additional parameters depending on site activities and conditions (Contact NMED- SWQB for an alternate list)*

*For further assistance determining whether dewatering may encounter contaminated sources, please contact the NMED Ground Water Quality Bureau at 505-827-2965 or NMED Surface Water Quality Bureau (SWQB) at 505-827-0187.

** EPA approved sufficiently sensitive methods must be used. For known PCB sources and analysis, EPA Method 1668C must be used (see <https://www.epa.gov/cwa-methods>).

2. If dewatering activities are anticipated, information on the flow rate and potential to encounter contaminated groundwater, subsurface water, spring water, or dewatering water must be provided directly to NMED at the following address:

NMED Surface Water Quality Bureau
 Program Manager, Point Source Regulation
 Section PO Box 5469, Santa Fe, NM 87502

Please call the SWQB to obtain the appropriate email address (505-827-0187).

3. In addition, the Operator/Permittee must characterize the quality of the groundwater and subsurface water, spring water, or dewatering water being considered for discharge according to the table above and including dissolved hardness and pH. Considering the contaminant sources listed in the table above, water quality data may already be available. For further assistance, contact the

erosion and sediment control systems based on these models (or equivalent soil loss prediction tools). Qualifications of the preparer (e.g., professional certifications, description of appropriate training) must be documented in the SWPPP. The Operator(s) must design, implement, and maintain BMPs in the manner specified in the SWPPP.

NMED supports the use of EPA's small residential lot template if a site qualifies to use it as explained in the permit, as long as it is consistent with the above requirements. NMED's requirement does not preclude small residential sites from using the template, but it may require an additional short paragraph to justify the selection of specific BMPs for the site.

- d. Operators must notify NMED when discharges of toxic or hazardous substances or oil from a spill or other release occurs - see Emergency Spill Notification Requirements, Part 2.3.6 of the permit. For emergencies, Operators can call 505-827-9329 at any time. For non-emergencies, Operators can call 866-428-6535 (voice mail 24-hours per day) or 505-476-6000 during business hours from 8am-5pm, Monday through Friday. Operators can also call the NMED Surface Water Quality Bureau directly at 505-827-0187.
- e. Operators of small construction activities (i.e., 1-5 acres) are not eligible to qualify for a waiver in lieu of needing to obtain coverage under this general permit based on Item C.3 of Appendix C (Equivalent Analysis Waiver) in the State of New Mexico.

9.6.2 NMR10I000 Indian country within the State of New Mexico, except Navajo Reservation Lands that are covered under Arizona permit AZR10000I and Ute Mountain Reservation Lands that are covered under Colorado permit COR10000I.

a. Nambe Pueblo

- i. The operator must provide a copy of the Notice of Intent (NOI) and Notice of Termination (NOT) to the Nambe Pueblo Governor's Office at the same time it is provided to the US Environmental Protection Agency. The NOI and NOT should be provided to the following address:
 - Office of the Governor Nambe Pueblo
 - ISA NPI02 WEST
 - Nambe Pueblo, New Mexico 87506
- ii. The operator must provide a copy of the Storm Water Pollution Prevention Plan (SWPPP) to Nambe Pueblo at the same time it is submitted to the EPA, either by email to governor@nambepueblo.org or mailed to the above address.
- iii. The operator must provide copies of inspection reports, a copy of the corrective action log, and modifications made to the SWPPP as a result of inspection findings, upon request by the Nambe Pueblo Department of Environmental and Natural Resources or Nam be Governor.

b. Ohkay Owingeh Tribe

- i. All operators obtaining permit coverage under the EPA CGP, must submit a copy of the certified (signed) Notice of Intent (NOI) to the Ohkay Owingeh Office of Environmental Affairs, a copy of NOI modifications and the Notice of Termination (NOT), must be provided within three business days after EPA provides electronic confirmation that the submission has been received. The NOI and NOT must be

provided to the following address:

Naomi L. Archuleta - Environmental Programs Manager Ohkay Owingeh
Office of Environmental Affairs
P.O. Box 717
Ohkay Owingeh, NM 87566
naomi.archuleta@ohkay.org

Noah Kaniatobe - Environmental Specialist Ohkay Owingeh, Office of
Environmental Affairs
P.O. Box 717
Ohkay Owingeh, NM 87566
noah.kaniatohe@ohkay.org

- ii. All operators obtaining permit coverage under the EPA CGP, must submit an electronic copy of the Storm Water Pollution Prevention Plan (SWPPP) to Ohkay Owingeh Office of Environmental Affairs at the same time that the NOI is submitted to the tribe (see contact information listed above).
- iii. Following each incident where the operator takes a corrective action the operator must provide the corrective action log to the Ohkay Owingeh Office of Environmental Affairs.
- iv. The operator must notify Ohkay Owingeh Office of Environmental Affairs within 24 hours, in the event of an emergency spill in addition to the notification requirements at Part 2.3.6 of the CGP. Please contact: Ohkay Owingeh Tribal Police Department at 505.852.2757.

Please contact:
Ohkay Owingeh
Tribal Police Department
505.852.2757

c. Pueblo of Isleta

- i. All operators obtaining permit coverage under the EPA CGP must submit a copy of the certified Notice of Intent (NOI) to the Pueblo of Isleta at the same time it is submitted to EPA for projects occurring within the exterior boundaries of the Pueblo of Isleta. Additionally, a copy of NOI modifications and the Notice of Termination (NOT), must be provided within three business days after EPA provides electronic confirmation that the submission has been received. The Notices must be provided to the following address:

Water Quality Control Officer Pueblo of Isleta
Environment Department PO Box 1270
Isleta NM 87022
505-869-7565
WQCO@isletapueblo.com

- ii. The operator must notify the Pueblo of Isleta's Dispatch at 505-869-3030 as soon as possible and the Pueblo of Isleta Water Quality Control Officer within 10 hours, in the event of a spill of hazardous or toxic substances or if health or the

environment become endangered in addition to the notification requirements at Part 2.3.6 and at I.12.6.1 of the CGP.

- iii. All operators obtaining permit coverage under the EPA CGP must submit an electronic copy of the Stormwater Pollution Prevention Plan (SWPPP) to the Pueblo of Isleta Water Quality Control Officer at the above address, 30 days prior to submitting the certified NOI to EPA. If the electronic file is too large to send through e-mail, a zip file or flash drive may be submitted.
 - iv. All operators obtaining permit coverage under the EPA CGP must give 2 days advance notice to the Pueblo of Isleta Water Quality Control Officer of any planned changes in the permitted activity which may result in noncompliance with permit requirements.
 - v. All operators obtaining permit coverage under the EPA CGP must post a sign or other notice of permit coverage at a safe, publicly accessible location in close proximity to the construction site. The notice must be located so that it is visible from the public road or tribal road that is nearest to the active part of the construction site. The sign must be maintained on-site from the time construction activities begin until final stabilization is met.
 - vi. Erosion and sediment controls shall be designed to retain sediment on-site and project-generated waste materials that have the potential to discharge pollutants shall not be placed on open soil or on a surface that is not stabilized. Volumes of sediment over five (5) cubic yards must be removed from the active construction site; additionally, if sediment is placed for disposal within the exterior boundaries of the Pueblo of Isleta, disposal must be within a tribally approved sediment disposal site.
- d. Pueblo of Laguna**
- i. All operators obtaining permit coverage under the EPA CGP must submit an electronic copy of the certified (signed) Notice of Intent (NOI) to the Pueblo of Laguna's Environmental & Natural Resources Department (ENRD) within three business days of submittal to the EPA. Additionally, a copy of NOI modifications and the Notice of Termination (NOT), must be provided within three business days after the EPA provides electronic confirmation that the submission has been received. The NOI and NOT must be electronically submitted to info.environmental@pol-nsn.gov.
 - ii. All operators obtaining permit coverage under the EPA CGP must submit an electronic copy of the Stormwater Pollution Prevention Plan (SWPPP) to the Pueblo of Laguna's ENRD 14 days prior to the submittal of the NOI (see contact information listed above).
 - iii. The operator must provide copies of corrective actions logs and modifications made to the SWPPP as a result of inspection findings to the Pueblo of Laguna ENRD (see contact information above).
 - iv. In addition to the notification requirements of Part 2.3.6 of the CPG **[EPA interprets this intending to refer to the CGP]**, the operator must notify the Pueblo of Laguna ENRD at 505-552-7512 in the event of an emergency spill as soon as possible.
- e. Pueblo of Sandia. The following conditions apply only to discharges on the Pueblo of Sandia Reservation:**

provided within three business days after EPA provides electronic confirmation that the submission has been received. The NOI and NOT must be provided to the following address:

Regular U.S. Delivery Mail:

Pueblo of Santa Ana
 Department of Natural Resources Water Resources Division
 Attn: Andrew Sweetman 02 Dove Rd
 Santa Ana Pueblo, NM 87004

Electronically:

Andrew Sweetman
 Water Resources Division Manager Andrew.Sweetman@santaana-nsn.gov
 Tammy Montoya Hydrologist
 Tammy.Montoya@santaana-nsn.gov

- ii. All operators obtaining permit coverage under the EPA CGP, must submit an electronic copy of the Stormwater Pollution Prevention Plan (SWPPP) to the Pueblo's Department of Natural Resources at the same time that the NOI is submitted to the tribe (see contact information listed above).
- iii. The operator must provide copies of inspection reports, a copy of the corrective action log, and modifications made to the SWPPP as a result of inspection findings, upon request by the Pueblo's Department of Natural Resources.
- iv. The operator must notify the Pueblo's Department of Natural Resources within 24 hours in the event of an emergency spill, in addition to the notification requirements at Part 2.3.6 of the CGP.

g. Pueblo of Taos

- i. All operators obtaining permit coverage under the EPA CGP, must submit a copy of the certified (signed) Notice of Intent (NOI) to the Taos Pueblo Environmental Office and Taos Pueblo Governor's Office within three business days of submittal to EPA. Additionally, a copy of NOI modifications and the Notice of Termination (NOT), must be provided within three business days after EPA provides electronic confirmation that the submission has been received. The NOI and NOT must be provided to the following addresses:

Honorable Governor of Taos Pueblo PO Box 1846
 Taos, New Mexico 87571

Taos Pueblo Environmental Office PO Box 1846
 Taos, New Mexico 87571
- ii. All operators obtaining permit coverage under the EPA CGP, must submit an electronic copy of the Stormwater Pollution Prevention Plan (SWPPP) to the Taos Pueblo Environmental Office when the NOI is submitted to the tribe. Electronic copy of SWPPP downloaded on flash drive may be sent to the above address for the Taos Pueblo Environmental Office.
- iii. The operator must provide a copy of the corrective action log following each corrective action undertaken and modifications made to the SWPPP as a result of

a corrective action to the Taos Pueblo Environmental Office at address listed above.

h. Pueblo of Tesuque.

- i. All operators obtaining permit coverage under the EPA CGP, must submit a copy of the certified (signed) Notice of Intent (NOI) to the Pueblo of Tesuque Department of Environment and Natural Resources (DENR) and the Pueblo's Governor within three business days of submittal to EPA. Additionally, a copy of any NOI modifications and the Notice of Termination (NOT), must be provided within three business days after EPA provides electronic confirmation that the submission has been received. The NOI and NOT must be provided to the following address:

Governor Mark Mitchell Pueblo of Tesuque
20 TP 828
Santa Fe, NM 87506 governor@pueblooftesuque.org

Sage Mountain.flower Pueblo of Tesuque
Department of Environment and Natural Resources Director
20 TP 828

- ii. All operators obtaining permit coverage under the EPA CGP, must submit an electronic copy of the Stormwater Pollution Prevention Plan (SWPPP) to Pueblo of Tesuque DENR and the Pueblo's Governor at the same time that the NOI is submitted to the EPA (see contact information listed above).
- iii. The operator must provide a copy of the corrective action log, and any modifications made to the SWPPP as a result of inspection findings, or upon request by the Pueblo of Tesuque DENR.
- iv. The operator must notify the Pueblo of Tesuque DENR within 24 hours in the event of an emergency spill, in addition to the notification requirements at Part 2.3.6 of the CGP (see contact information listed above).

i. Santa Clara Indian Pueblo.

- i. All operators obtaining permit coverage under the EPA CGP, must submit a copy of the certified (signed) Notice of Intent (NOI) to the Santa Clara Pueblo Office of Environmental Affairs at the same time the NOI is submitted to the U.S. EPA. Additionally, a copy of the NOI modifications and the Notice of Termination (NOT), must be provided at the same time after electronic confirmation is received from EPA that the NOT has been accepted. The NOI and NOT shall be provided to the following address in electronic format:

Dino Chavarria,
Santa Clara Pueblo
Office of Environmental Affairs
dinoc@santaclarapueblo.org

- ii. All operators obtaining permit coverage under the EPA CGP, must submit an electronic copy of the Stormwater Pollution Prevention Plan to the Santa Clara Pueblo Office of Environmental Affairs at the same time the NOI is submitted to the U.S. EPA (see contact information listed above).

- iii. The operator must notify the Santa Clara Pueblo Office of Environmental Affairs at the address above within 24 hours, in the event of an emergency spill, in addition to the notification requirements at Part 2.3.6 of the CGP
- 9.6.3 OKR10I000 Indian country within the State of Oklahoma, except areas of Indian country covered by an extension of state program authority pursuant to Section 10211 of the Safe, Accountable, Flexible, Efficient Transportation Equity Act (SAFETEA).**
- a. **Pawnee Nation. The following conditions apply only to discharges within Pawnee Indian country:**
 - i. Copies of the Notice of Intent (NOI) and Notice of Termination (NOT) must be provided to the Pawnee Nation at the same time it is submitted to the Environmental Protection Agency to the following address:
Pawnee Nation Department of Environmental Conservation and Safety
P.O. Box 470
Pawnee, OK 74058
Or email to dnrs@pawneenation.org
 - ii. An electronic copy of the Storm Water Pollution Prevention Plan (SWPPP) must be submitted to the Pawnee Nation Department of Environmental Conservation and Safety at the same time the NOI is submitted.
 - iii. The operator must provide access to the site for inspections and for copies of inspection reports, copy of the corrective action log and modifications, made to the SWPPP because of inspection findings, upon request by the Pawnee Nation DECS.
 - iv. The Pawnee Nation Department of Environmental Conservation and Safety must be notified at 918.762.3655 immediately upon discovery of any noncompliance with any provision of the permit conditions.
- 9.6.4 OKR10F000 Discharges in the State of Oklahoma that are not under the authority of the Oklahoma Department of Environmental Quality, or the Oklahoma Department of Agriculture and Forestry including activities associated with oil and gas exploration, drilling, operations, and pipelines (includes SIC Groups 13 and 46, and SIC codes 492 and 5171), and point source discharges associated with agricultural production, services, and silviculture (includes SIC Groups 01, 02, 07, 08, 09).**
- a. For activities located within the watershed of any Oklahoma Scenic River, including the Illinois River, Flint Creek, Barren Fork Creek, Upper Mountain Fork, Little Lee Creek, and Lee Creek or any water or watershed designated "ORW" in Oklahoma's Water Quality Standards, this permit may only be used to authorize discharges from temporary construction activities. Certification is denied for any on-going activities such as sand and gravel mining or any other mineral mining.
 - b. For activities located within the watershed of any Oklahoma Scenic River, including the Illinois River, Flint Creek, Barren Fork Creek, Upper Mountain Fork, Little Lee Creek, and Lee Creek or any water or watershed designated "ORW" in Oklahoma's Water Quality Standards, certification is denied for any discharges originating from support activities, including, but not limited to, concrete or asphalt batch plants, equipment staging yards, material storage areas, excavated material disposal areas, or borrow areas.

- c. Dewatering discharges into sediment or nutrient-impaired waters, and waters identified as Tier 2, Tier 2.5, or Tier 3 (OAC 785:46-13) shall be controlled to meet water quality standards for turbidity in those waters as follows:
 - i. Cool Water Aquatic Community/Trout Fisheries: 10 NTUs (OAC 785: 45-5-12(f)(7)(A)(i))
 - ii. Lakes: 25 NTUs (OAC 785: 45-5-12(f)(7)(A)(ii))
 - iii. In waters where background turbidity exceeds these values, turbidity from dewatering discharges should be restricted to not exceed ambient levels (OAC 785: 45-5-12(f)(7)(B))

9.7 EPA REGION 7

No additional conditions.

9.8 EPA REGION 8

9.8.1 MTR10I000 Indian country within the State of Montana

a. Blackfeet Nation.

- i. The Applicant and applicants for projects authorized under the NWP's should obtain all other permits, licenses, and certifications that may be required by federal, state, or tribal authority. Primary relevant tribal permit will be ALPO (Ordinance 117). Others may apply. It is the applicant's responsibility to know the tribal and local ordinances and complete all necessary permissions before they can commence work.
- ii. If a project is unable to meet the enclosed conditions, or if certification is denied for an applicable NWP, the Applicant may request an individual certification from Blackfeet. An individual certification request must follow the requirements outlined in 40 CFR 121.5 of EPA's CWA § 401 Certification Rule, effective September 11, 2020.
- iii. Copies of this certification should be kept on the job site and readily available for reference.
- iv. If the project is constructed and/or operated in a manner not consistent with the applicable NWP, general conditions, or regional conditions, the permittee may be in violation of this certification.
- v. Blackfeet and EPA representatives may inspect the authorized activity and any mitigation areas to determine compliance with the terms and conditions of the NWP.
- vi. This NWP Reissuance does not reduce Tribal authority under any other rule.
- vii. The project, including any stream relocations and restoration, must be built as shown and as otherwise described in the application, the construction plans, cross sections, mitigation plans and other supporting documents submitted to this office. Impacts to aquatic systems and restoration efforts will be monitored by an appropriate aquatic resource professional to ensure that disturbed areas are restored to at least their original condition.
- viii. All existing water uses will be fully maintained during and after the completion of the project. (If applicable)

- ix.** Where practicable, perform all in-channel and wetland work during periods of low flow or drawn—down or when dry
- x.** Equipment staging areas must be located out of all delineated wetlands
- xi.** Appropriate soil erosion and sediment controls must be used and maintained in effective operating condition during and immediately after construction, and all exposed soil and other fills, as well as any work below the ordinary high-water mark or in a wetland, must be permanently stabilized as soon as possible
- xii.** Materials such as piling, culverts, sandbags, fabric, mats, timbers used for temporary facilities in wetlands or below the high- water mark of Waters of the US must be free from oil, gas, excess dirt, loose paint and other pollutants.
- xiii.** Equipment staging areas in wetlands or in stream or river channels must be placed on mats, or other measures must be taken to minimize soil disturbance and compaction.
- xiv.** Clearing of riparian or wetland vegetation for the sole purpose of constructing work bridges, detours, staging areas or other temporary facilities must be limited to the absolute minimum necessary. When temporary impacts to native riparian or wetland vegetation are unavoidable, it must be mowed or cut above ground with the topsoil and root mass left intact.
- xv.** Remove all temporary fills and structures in the entirety when they are no longer needed. Restore affected areas to the appropriate original and planned contours where possible. Re-vegetate disturbed areas with appropriate native species when native species are impacted.
- xvi.** Construction methods and best management practices (BMPs) must minimize aquatic resource impacts to the maximum extent possible. Any BMPs described in the Joint Application must be followed. BMPs should include installation and maintenance of sediment control measures; separation, storage and reuse of any topsoil; and recovery of all disturbed areas where possible. All best management practices must in place prior to the onset of construction or as soon as practicable during the construction process.
- xvii.** Best available technology and/or best management practices must be utilized to protect existing water uses and maintain turbidity and sedimentation at the lowest practical level.
- xviii.** Applicant/contractor should manage disturbed streambank topsoil in a manner that optimizes plant establishment for the site.
- xix.** When operating equipment or otherwise undertaking construction in wetlands and water bodies the following conditions apply:
 - (k) Work should be done in dry conditions if possible.
 - (l) All equipment is to be inspected for oil, gas, diesel, anti-freeze, hydraulic fluid or other petroleum leaks. All such leaks will be properly repaired and equipment cleaned prior to being allowed on the project site. Leaks that occur after the equipment is moved to the project site will be fixed the same day or the next day or removed from the project area. The equipment is not allowed to continue operation once a leak is discovered.

- (m) All equipment is to be inspected and cleaned before and after use to minimize the spread or introduction of invasive or undesirable species.
- (n) Construction equipment shall not operate below the existing water surface except as follows:
- Impacts from construction should be minimized through the use of best management practices submitted in the permit application.
 - Essential work below the waterline shall be done in a manner to minimize impacts to aquatic system and water quality.
- (o) Containment booms and/or absorbent material must be available onsite. Any spills of petroleum products must be reported to the Army Corps, Blackfeet Nation BEO Office and the US EPA within 24 hours.
- xx.** Upland, riparian and in-stream vegetation should be protected except where its removal is necessary for completion of work. Revegetation should be completed as soon as possible. Applicant/contractor should revegetate disturbed soil in a manner that optimizes plant establishment for the site. Revegetation must include topsoil replacement, planting, seeding, fertilization, liming and weed-free mulching as necessary. Applicant must use native plant material and soils where appropriate and feasible. This certification does not allow for the introduction of non-native flora and fauna. All disturbed surface areas must be restored to pre-construction contours and elevation.
- xxi.** Spoils piles should not be placed or stored within the delineated wetlands or streams unless protected by a temporary structure designed to divert and handle high flows that can be anticipated during permit activity. Spoils piles should be placed on landscaping fabric or some other material to separate spoils material and allow retrieval of spoils material with minimal impact.
- xxii.** Impacts to wetlands shall not exceed 4.92 acres.
- xxiii.** Any unexpected and additional impacts to waters of the US should be reported to the
- xxiv.** Army Corps, Blackfeet Environmental Office Water Quality Coordinator and the US EPA.
- xxv.** All instream and stream channel reconstruction work must be completed before the stream is diverted into the new channel.
- xxvi.** Any temporary crossings, bridge supports, cofferdams, or other structures that are necessary during permit activity should be designed to handle high flows that can be anticipated during permit activity. All temporary structures should be completely removed from the water body at the conclusion of the permitted activity and the area restored to a natural function and appearance.
- xxvii.** The certification does not authorize any unconfined discharge of liquid cement into the waters of the United States. Grouting riprap must occur under dry conditions with no exposure of wet concrete to the water body.
- xxviii.** BMPs shall include application of certified weed-free straw or hay across all disturbed wetland areas that are temporarily impacted; installation and maintenance of sediment control measures during construction and if necessary, after construction is completed; use of heavy mud mats if necessary; separation,

storage and reuse of all streambank topsoil and wetland topsoil, as appropriate; and recovery of all disturbed wetland and streambank areas where possible. All conditions set by the Blackfeet Tribe and US Army Corps must be followed.

- xxix.** All applicants, including federal agencies, must notify EPA and the Blackfeet Environmental Office of the use of all NWPs for which certification has been granted prior to commencing work on the project. Notifications must include:
- (p) project location (lat. Long., exact point on map);
 - (q) NWP that will be used and the specific activity that will be authorized under the NWP;
 - (r) amount of permanent and temporary fills;
 - (s) a short summary of the proposed activity, and all other federal, state, tribal or local permits or licenses required for the project;
 - (t) complete contact information of both the applicant and contractor (name, name of the company or property if applicable, telephone, mobile, and email); and,
 - (u) Summary of best management practices that will be used.
 - (v) A summary of communications with the affected Tribe's water quality staff regarding the project, including any concerns or issues.
 - (w) Notify Blackfeet and EPA at least 7 days before the completion of construction and operations begin.
- xxx.** Point source discharges may not occur: (1) in fens, bogs or other peatlands; (2) within 100 feet of the point of discharge of a known natural spring source; or (3) hanging gardens.
- xxx.i.** Except as specified in the application, no debris, silt, sand, cement, concrete, oil or petroleum, organic material, or other construction related materials or wastes shall be allowed to enter into or be stored where it may enter into waters of the U.S.
- xxxii.** Silt fences, straw wattles, and other techniques shall be employed as appropriate to protect waters of the U.S. from sedimentation and other pollutants.
- xxxiii.** Water used in dust suppression shall not contain contaminants that could violate water quality standards.
- xxxiv.** Erosion control matting that is either biodegradable blankets or loose-weave mesh must be used to the maximum extent practicable.
- xxxv.** All equipment used in waters of the U.S. must be inspected for fluid leaks and invasive species prior to use on a project. All fluid leaks shall be repaired and cleaned prior to use or when discovered, or if the fluid leak can't be repaired, the equipment shall not be used on site. Equipment used in waters with the possibility of aquatic nuisance species infestation must be thoroughly cleaned and effectively decontaminated before they are used on the project.

- xxxvi.** Vegetation should be protected except where its removal is necessary for completion of the work. Locations disturbed by construction activities should be revegetated with appropriate native vegetation in a manner that optimizes plant establishment for the specific site.
- xxxvii.** Revegetation may include topsoil replacement, planting, seeding, fertilization, liming, and weed-free mulching, as necessary. Where practical, stockpile weed- seed-free topsoil and replace it on disturbed areas. All revegetation materials, including plants and plant seed shall be on site or scheduled for delivery prior to or upon completion of the earth moving activities.
- xxxviii.** Activities may not result in any unconfined discharge of liquid cement into waters of the U.S. Grouting riprap must occur under dry conditions with no exposure of wet concrete to the waterbody.
- xxxix.** Activities that may result in a point source discharge shall occur during seasonal low flow or no flow periods to the extent practicable.
- xl.** The placement of material (discharge) for the construction of new dams is not certified, except for stream restoration projects.
- xli.** Any decision-maker that is required under 7.0 of the CGP to prepare a Stormwater Pollution Prevention Plan (SWPPP), must submit an electronic copy of the SWPPP to the Blackfeet Environmental Office at least 30 days before construction starts for review and approval. Any modifications to the SWPPP should be submitted to the Blackfeet Environmental Office.
- xlii.** Any Decision-maker required under Part 1.4 of the CGP to submit a Notice of Intent (NOI) to EPA for coverage under the CGP, must submit a copy of the NOI to the Blackfeet Environmental Office within three business days of submittal to EPA. Additionally, a copy of the Notice of Termination (NOT) must be provided within three business days after electronic confirmation is received from EPA that the NOT has been accepted. The NOI and NOT must be provided to the following address Gerald Wagner, Blackfeet Environmental Office Director.
62 Hospital Drive, Browning, MT 59417
beo.director@gmail.com

b. Fort Peck Tribes.

- i.** Any Decision-maker required under Part 1.4 of the CGP to submit a Notice of Intent (NOI) to EPA for coverage under the CGP, must submit a copy of the NOI to the Fort Peck Tribes Office of Environmental Protection within three business days of submittal to EPA. Additionally, a copy of the Notice of Termination (NOT) must be provided within three business days after electronic confirmation is received from EPA that the NOT has been accepted. The NOI and NOT must be provided to the following address:
Martina Wilson, Office of Environmental Protection Director
501 Medicine Bear Rd Poplar, MT 59255
martinawilson@fortpecktribes.net
- ii.** Any Decision-maker that is required under Part 7.0 of the CGP to prepare a Stormwater Pollution Prevention Plan (SWPPP), must submit an electronic copy of the SWPPP to the Fort Peck Tribes Office of Environmental Protection at least 30 days before construction starts for review and approval. Any modifications to the

SWPPP should be submitted to the Fort Peck Tribes Office of Environmental Protection.

- iii. Any Decision-maker that is required under Part 8.0 of the CGP to submit a weekly, bi-weekly, and/or annual report to EPA, must submit an electronic copy of the annual report to the Fort Peck Tribes Office of Environmental Protection within three business days after submittal to EPA.

9.9 EPA REGION 9

9.9.1 CAR10I000 Indian country within the State of California

a. Morongo Band of Mission Indians

- i. A copy of the Stormwater Pollution Prevention Plan (SWPPP) must be submitted (either mailed or electronically) to the MEPD no less than thirty (30) days before commencing construction activities:
 - Morongo Band of Mission Indians
 - Environmental Protection Department
 - 12700 Pumarra Road
 - Banning, CA 92220
 - Email: epd@morongo-nsn.gov
- ii. Copies of the Notice of Intent (NOI) and the Notice of Termination (NOT) must be sent to the MEPD at the same time they are submitted to EPA.
- iii. Operators of an "emergency-related project" must submit notice to the MEPD within twenty- four (24) hours after commencing construction activities.
- iv. Spills, leaks, or unpermitted discharges must be reported to the MEPD within twenty-four (24) hours of the incident, in addition to the reporting requirements of the CGP.
- v. Projects utilizing cationic treatment chemicals (as defined in Appendix A of the CGP) within the Morongo Reservation are not eligible for coverage under this certification of the CGP.
- vi. Facilities covered under the CGP will be subject to compliance inspections by MEPD staff, including compliance with final site stabilization criteria prior to submitting an NOI **[EPA assumes this intended to refer to an NOT]**.

9.9.2 GUR100000 Island of Guam

- a. For purposes of this Order, the term "Project Proponent" shall mean U.S. Environmental Protection Agency, and its agents, assignees, and contractors.
- b. For purposes of this Order, the permit "Operator" shall mean any party associated with a construction project that meets either of the following two criteria:
 - i. The party has operational control over construction plans and specifications, including the ability to make modifications to those plans and specifications (e.g. in most cases this is the owner of the site); or
 - ii. The party has day-to-day operational control of those activities at a project that are necessary to ensure compliance with the permit conditions (e.g., they are authorized to direct workers at a site to carry out activities required by the permit; in most cases this is the general contractor of the project).

Subcontractors generally are not considered operators for the purposes of this permit.

- c.** The Project Proponent shall enforce the proposed 2022 CGP and ensure that the Operator complies with the conditions of the permit at all times.¹⁰⁸ (40 CFR §121.11(c))
- d.** All submittals required by this Order shall be sent to the Guam Environmental Protection Agency Attn: 401 Federal Permit Manager, Non-Point Source Program, EMAS Division, 3304 Mariner Avenue, Bldg. 17-3304, Barrigada, Guam 96913, AND via email to jesse.cruz@epa.guam.gov. The submittals shall be identified with WQC Order #2021- 04 and include the COP Permit Number, certifying representative's name, title, mailing address and phone number. (§51060)(4) 2017 GWQS)
- e.** A copy of the Operator's signed Stormwater Pollution Prevention Plan (SWPPP) and signed Notice of Intent (NOI) and Notice of Termination (NOT) submitted to EPA for review and approval, shall concurrently be submitted to Guam EPA, consistent with condition A4. Coordination with Guam EPA is encouraged when the receiving water(s) for the proposed discharge is/are being identified. (§10105.B.5.d.) GSESCR; (§51060)(4) 2017 GWQS)
- f.** The Operator must comply with the conditions and requirements set forth in 22 GAR 10, Guam Soil Erosion and Sediment Control Regulations (GSESCR).
- g.** Before submitting the NOT to EPA, Operators shall comply with GSESCR regulations at §10105.B10. (Stabilization of Affected Areas) and §10107.B. (Final Inspection and Approval)
- h.** All operators/owners shall comply with the general design criteria for best management practices (BMPs) acceptable for meeting the Construction and Post-construction stormwater criteria in the 2006 CNMI and Guam Stormwater Management Manual. (E.O. 2012-02)
- i.** Operating reports and monitoring and analytical data (e.g. Discharge Monitoring Reports (DMRs), follow-up monitoring reports, Exceedance Reports for Numerical Effluent Limits, etc.) submitted to EPA shall be concurrently submitted to Guam EPA, consistent with condition A4. §51060)(4) 2017 GWQS
- j.** The Operators who install a sediment basin or similar impoundment shall maintain the storage capacity of five thousand cubic feet {5,000 cu. ft.) per acre of project area tributary to the basin. (§10105.B.5.i.) GSESCR
- k.** (1) This Order does not authorize EPA to qualify Rainfall Erosivity Waivers to stormwater discharges associated with small construction activities (i.e. 1-5 acres). Operators are required to apply for an NOI for those projects eligible for coverage under the proposed 2022 CGP. An Erosion and Sediment Control Plan is required for every site that would be covered by the proposed 2022 CGP. (22 GAR §10104) The average annual rainfall for Guam and the CNMI exceeds 100 inches per year in many locations. These climatic conditions combined with the region's unique limestone, volcanic geologic formations, sensitive water resources and significant land

¹⁰⁸ By incorporating this condition into the permit, EPA acknowledges receipt of Guam's certification conditions.

development forces make stormwater discharges a very significant environmental and economic issue. (2006 CNMJ/Guam Stormwater Management Manual) E.O. 2012-02

(2) This Order does not authorize EPA to approve a Sediment TMDL Waiver for the Ugum River. Operators of construction activities eligible for a TMDL Waiver in lieu of coverage under the proposed 2022 CGP, shall submit a complete and accurate waiver certification as described in C.2., Appendix C - (Small Construction Waivers) to Guam EPA per condition A4., prior to notifying EPA of its intention to obtain a waiver. §51060)(4) 2017 GWQS

- l.** The Project Proponent shall submit to Guam EPA a signed Statement of Understanding of Water Quality Certification Conditions.¹⁰⁹ (see Attachment A for an example) per condition A4. §51060)(4) 2017 GWQS
- m.** The Operator shall comply with applicable provisions of the Guam Pesticides Act of 2007 (10 GCA Chapter 50) and implementing regulations at Title 22 GAR Chapter 15 for any use and application of pesticides.
- n.** Point source discharge(s) to waterbodies under the jurisdiction of Guam EPA must be consistent with the antidegradation policy in 22 GAR §5101(b).
- o.** The operator shall carry out construction activities in such a manner that will not violate Guam Water Quality Standards (GWQS). Proposed 2022 CGP discharges are prohibited as follows:
 - i.** In Marine Waters, Category M-1 Excellent 22 GAR Chapter 5 §5102(b)(I); and
 - ii.** In Surface Waters, Category S-1 High 22 GAR Chapter 5 §5102(c)(I)
- p.** In addition to complying with construction dewatering requirements in Part 2.4 and site inspection requirements for all areas where construction dewatering is taking place in Part 4 of the proposed 2022 CGP, Operators shall comply with all dewatering conditions and requirements set forth in 22 GAR 7, Water Resources Development and Operating Regulations, to include securing Guam EPA permits prior to any dewatering activities.
- q.** The Operator shall develop and implement a Spill Prevention and Containment Plan.
- r.** The Operator shall have adequate and appropriate spill response materials on hand to respond to emergency release of oil, petroleum or any other material into waters of the territory.
- s.** Any unpermitted discharge into territorial waters or onto land with a potential for entry into territorial waters, is prohibited. If this occurs, the Operator shall immediately take the following actions:
 - i.** Cease operations at the location of the violation or spill.
 - ii.** Assess the cause of the water quality problem and take appropriate measures to correct the problem and/or prevent further environmental damage.
 - iii.** Notify Guam EPA of the failure to comply. All petroleum spills shall be reported immediately to:

¹⁰⁹ By incorporating this condition into the permit, EPA acknowledges receipt of Guam's certification conditions.

- (x) Guam's Emergency 911 system
 - (y) Guam EPA's 24-Hour Spill Response Team at (671) 888-6488 or during working hours (671) 300-4751
 - (z) US Coast Guard Sector Guam (671) 355-4824
 - (aa) National Response Center 1-800-424-8802
- iv.** Submit a detailed written report to Guam EPA within five days of noncompliance that describes the nature of the event corrective action taken and/or planned, steps to be taken to prevent a recurrence, results of any samples taken, and any other pertinent information.
- f.** Compliance with this condition does not relieve the Operator from responsibility to maintain continuous compliance with the terms and conditions of this Order or the resulting liability from failure to comply.
- u.** Submittal or reporting of any of this information does not provide relief from any subsequent enforcement actions for unpermitted discharges to waters of the United States.
- v.** This Order is valid for five (5) Years from Date of Certification, unless otherwise approved by the Guam EPA Administrator.
- w.** The Operator shall be required to adhere to the current Guam Coral Spawning Moratorium dates for both hard and soft corals where in-water activities and/or construction activity in close proximity with marine waters may impair water quality. These dates can be obtained from the Guam Department of Agriculture, Division of Aquatic and Wildlife Resources, or the NOAA NMFS Pacific Islands Regional Office Habitat Conservation Division.
- x.** The Operator shall provide notice to Guam EPA consistent with Condition A4:
- (a) Immediately upon discovery of noncompliance with the provisions of this Order.
- y.** A Notice of Violation/Work Stop Order will be issued if certification conditions are not adhered to or when significant or sustained water quality degradation occurs. Work or discharge shall be suspended or halted until the Operator addresses environmental problems/concerns to Guam EPA's satisfaction. Guam EPA may also levy penalties and fines (10 GCA §47111). Invalidity or enforceability of one or more provisions of this certification shall not affect any other provision of this certification.

9.10 EPA REGION 10

9.10.1 IDR10I000 Indian country within the State of Idaho, except Duck Valley Reservation lands (see Region 9)

a. Shoshone-Bannock Tribes

- i.** Copies of the following information must be sent to the SBT-WRD:
 - (a) Notice of Intent (NOI)

The Notice of Intent shall be forwarded to the SBT-WRD within thirty (30) days of receipt of submitting NOI to the USEPA.

Shoshone-Bannock Tribes Water Resources Department
 PO Box 306 Pima Drive
 Fort Hall, ID 83203 Phone: (208) 239-4582
 Fax: (208) 239-4592
 Or Email ctanaka@sbttribes.com

- ii. If requested by the SBT-WRD, the permittee must submit a copy of the SWPPP to SBT- WRD within fourteen (14) days of the request.

9.10.2 ORR10I000 Indian country within the State of Oregon, except Fort McDermitt Reservation lands (see Region 9)

a. Confederated Tribes of Coos, Lower Umpqua, and Siuslaw

- i. No activities allowed under the CGP shall result in the degradation of any Tribal waters or affect resident aquatic communities or resident or migratory wildlife species at any life stage.
- ii. The operator shall be responsible for achieving compliance with CTCLUSI Water Quality Standards and all other tribal codes, regulations, and laws as they exist at the time that the permit is submitted.
- iii. The operator shall submit a copy of the Notice of Intent (NOI) to be covered by the general permit to the CTCLUSI Water Quality Program before, or at the same time as, it is submitted to EPA.
- iv. The operator shall be responsible for submitting all Stormwater Pollution Prevention Plans (SWPPP) required under this general permit to the CTCLUSI Water Quality Program for review and determination that the SWPPP is sufficient to meet Tribal Water Quality Standards, prior to the beginning of any discharge activities taking place.
- v. The operator shall be responsible for reporting an exceedance to Tribal Water Quality Standards to the CTCLUSI Water Quality Program at the same time it is reported to EPA.
- vi. The THPO will be provided 30 days to comment on the APE as defined in the permit application.
- vii. If the project is an undertaking, a cultural resource assessment must occur. All fieldwork must be permitted by the THPO (as appropriate), conducted by qualified personnel (as outlined by the Secretary of Interior's Standards and Guidelines; http://www.nps.gov/history/local-law/arch_stnds_O.htm) and documented according to Oregon Reporting Standards (Reporting_Guidelines.pdf) (oregon.gov). The resulting report must be submitted to the THPO and the THPO must concur with the finding of effect and recommendations before any ground disturbing work can occur. The THPO requires 30 days to review all reports.
- viii. The operator must obtain THPO concurrence in writing. If historic properties are present, this written concurrence will outline measures to be taken to prevent or mitigate adverse effects to historic properties.

b. Confederated Tribes of the Umatilla Indian Reservation

- i. The operator shall be responsible for achieving compliance with the Confederated Tribes of the Umatilla Indian Reservation's (CTUIR) Water Quality

Standards.

- ii. The operator shall submit a copy of the Notice of Intent (NOI) to be covered by the general permit to the CTUIR Water Resources Program at the address below, at the same time it is submitted to EPA.
- iii. The operator shall be responsible for submitting all Stormwater Pollution Prevention Plans (SWPPP) required under this general permit to the CTUIR Water Resources Program for review and determination that the SWPPP is sufficient to meet Tribal Water Quality Standards, prior to the beginning of any discharge activities taking place.
- iv. The operator shall be responsible for reporting an exceedance to Tribal Water Quality Standards to the CTUIR Water Resources Program at the same time it is reported to EPA.

Confederated Tribes of the Umatilla Indian Reservation
Water Resources Program
46411 Timine Way
Pendleton, OR 97801
(541) 429-7200

- v. The THPO will be provided 30 days to comment on the APE as defined in the permit application.
- vi. If the project is an undertaking, a cultural resource assessment must occur. All fieldwork must be permitted by the Tribal Historic Preservation Office (as appropriate), conducted by qualified personnel (as outlined by the Secretary of Interior's Standards and Guidelines; http://www.nps.gov/history/local-law/arch_stnds_0.htm) and documented according to Oregon Reporting Standards (Reporting_Guidelines.pdf (oregon.gov)). The resulting report must be submitted to the THPO and the THPO must concur with the finding of effect and recommendations before any ground disturbing work can occur. The THPO requires 30 days to review all reports.
- vii. The operator must obtain THPO concurrence in writing. If historic properties are present, this written concurrence will outline measures to be taken to prevent or mitigate adverse effects to historic properties.

9.10.3 WAR10F000 Areas in the State of Washington, except those located on Indian country, subject to construction activity by a Federal Operator

- a. For purposes of this Order, the term "Project Proponent" shall mean those that are seeking coverage under this permit, and its agents, assignees and contractors.
- b. The Federal Agency shall mean the US Environmental Protection Agency. The Federal Agency shall enforce the permit and ensure that the Project Proponent complies with the conditions of the permits at all times.
- c. Failure of any person or entity to comply with this Certification may result in the issuance of civil penalties or other actions, whether administrative or judicial, to enforce the terms of this Certification.
- d. The Certification conditions within this Order must be incorporated into EPA's final NPDES permit. Per 40 CFR 121.10(a), all certification conditions herein that satisfy the requirements of 40 CFR 121.7(d) must be incorporated into the permit. Per 40 CFR

121.10(b), the permit must clearly identify all certification conditions.

- e. This Certification does not authorize exceedances of water quality standards established in chapter 173-201A WAC.
- f. Discharges from construction activity must not cause or contribute to violations of the Water Quality Standards for Surface Water of the State of Washington (chapter 173-201A WAC), Ground Water Quality Standards (chapter 173-200 WAC), Sediment Management Standards (chapter 173-204 WAC), and standards in the EPA's Revision of certain Federal water quality criteria applicable to Washington (40 CFR 131.45). Discharges that do not comply with these standards are prohibited.
- g. Prior to discharge of stormwater and non-stormwater to waters of the State, the Permittee must apply all known, available, and reasonable methods of prevention, control, and treatment (AKART). This includes the preparation and implementation of an adequate Stormwater Pollution Prevention Plan (SWPPP), with all appropriate Best Management Practices (BMPs) installed and maintained in accordance with the SWPPP and the terms and conditions of the permit.
 - i. BMPs must be consistent with:
 - (a) The Stormwater Management Manual for Western Washington (most current approved edition at the time this permit was issued), for sites west of the crest of the Cascade Mountains; or
 - (b) The Stormwater Management Manual for Eastern Washington (most current approved edition at the time this permit was issued), for sites east of the crest of the Cascade Mountains; or
 - (c) Revisions to either manual, or other stormwater management guidance documents or manuals which provide equivalent level of pollution prevention, that are approved by Ecology and incorporated into this permit in accordance with the permit modification requirements of WAC 173-226-230. (For purposes of this section, the stormwater manuals listed in Appendix 10 of the Phase I Municipal Stormwater Permit are approved by Ecology); or
 - (d) Documentation in the SWPPP that the BMPs selected provided an equivalent level of pollution prevention, compared to the applicable stormwater management manuals, including:
 - The technical basis for the selection of all stormwater BMPs (scientific, technical studies, and/or modeling) that support the performance claims for the BMPs being selected.
 - An assessment of how the selected BMP will satisfy AKART requirements and the applicable federal technology-based treatment requirements under 40 CFR part 125.3.
 - ii. An adequate SWPPP must include a narrative and drawings. All BMPs must be clearly referenced in the narrative and marked on the drawings. The SWPPP narrative must include documentation to explain and justify the pollution

prevention decisions made for the project. Documentation must include:

(a) Information about existing site conditions (topography, drainage, soils, vegetation, etc.).

(b) Potential erosion problem areas.

(c) The 13 elements of a SWPPP, including BMPs used to address each element. Unless site conditions render the element unnecessary and the exemption is clearly justified in the SWPPP, the 13 elements are as follows:

- Preserve Vegetation/Mark Clearing Limits
- Establish Construction Access
- Control Flow Rates
- Install Sediment Controls
- Stabilize Soils
- Protect Slopes
- Protect Drain Inlets
- Stabilize Channels and Outlets
- Control Pollutants
- Control Dewatering
- Maintain BMPs
- Manage the Project
- Protect Low Impact Development (LID) BMPs

h. Discharges of stormwater and authorized non-stormwater must be monitored for turbidity (or transparency) and, in the event of significant concrete work or engineered soils, pH must also be monitored. As applicable based on project specifics, monitoring, benchmarks, and reporting requirements contained in Condition S.4. (pp.10-16) of the Washington State Construction Stormwater General Permit, effective January 1, 2021, shall apply.

i. Discharges to segments of waterbodies listed as impaired by the State of Washington under Section 303(d) of the Clean Water Act for turbidity, fine sediment, phosphorus, or pH must comply with the following numeric effluent limits:

Parameter identified in 303(d) listing	Parameter Sampled	Unit	Analytical Method	Numeric Effluent Limit
<ul style="list-style-type: none"> • Turbidity • Fine Sediment • Phosphorus 	Turbidity	NTU	SM2130	25 NTUs at the point where the stormwater is discharged from the site.
High pH	pH	su	pH meter	In the range of 6.5 – 8.5

All references and requirements associated with Section 303(d) of the Clean Water Act mean the most current EPA-approved listing of impaired waters that exists on the

effective date of the permit, or the date when the operator's complete permit application is received by EPA, whichever is later.

The EPA approved WQ Assessment can be found at: <https://ecology.wa.gov/Water-Shorelines/Water-quality/Water-improvement/Assessment-of-state-waters-303d>

- j.** Discharges to a waterbody that is subject to a Total Maximum Daily Load (TMDL) for turbidity, fine sediment, high pH, or phosphorus must be consistent with the TMDL.
 - i.** Where an applicable TMDL sets specific waste load allocations or requirements for discharges covered by this permit, discharges shall be consistent with any specific waste load allocations or requirements established by the applicable TMDL.
 - ii.** Where an applicable TMDL has established a general waste load allocation for construction stormwater discharges, but no specific requirements have been identified, compliance with this permit will be assumed to be consistent with the approved TMDL.
 - iii.** Where an applicable TMDL has not specified a waste load allocation for construction stormwater discharges, but has not excluded these discharges, compliance with this permit will be assumed to be consistent with the approved TMDL.
 - iv.** Where an applicable TMDL specifically precludes or prohibits discharges from construction activity, the operator is not eligible for coverage under this permit.

Applicable TMDL means a TMDL for turbidity, fine sediment, high pH, or phosphorus which has been completed and approved by EPA as of the effective date of the permit, or prior to the date of the operator's complete application for permit coverage is received by EPA, whichever is later.

- k.** Discharges to waters of the state from the following activities are prohibited:
 - i.** Concrete wastewater.
 - ii.** Wastewater from washout and clean-up of stucco, paint, form release oils, curing compounds and other construction materials.
 - iii.** Process wastewater as defined by 40 Code of Federal Regulations (CFR) 122.2.
 - iv.** Slurry materials and waste from shaft drilling, including process wastewater from shaft drilling for construction of building, road, and bridge foundations unless managed to prevent discharge to surface water.
 - v.** Fuels, oils, or other pollutants used in vehicle and equipment operation and maintenance.
 - vi.** Soaps or solvents used in vehicle and equipment washing.
 - vii.** Wheel wash wastewater, unless managed to prevent discharge to surface water.
 - viii.** Discharges from dewatering activities, including discharges from dewatering of trenches and excavations, unless managed according to appropriate controls described within the permit.
- l.** This Certification is valid until the expiration date including any administrative extension or termination date of the NPDES 2022 Construction General Permit. (40 CFR § 122.46)

- m. The Federal Agency shall enforce and the Project Proponent must comply with all the reporting and notification conditions of the NPDES 2022 Construction General Permit in order to comply with this Order and the certification conditions herein (40 CFR § 121.11).
- n. You have a right to appeal this Order to the Pollution Control Hearing Board (PCHB) within 30 days of the date of receipt of this Order. The appeal process is governed by chapter 43.21B RCW and chapter 371-08 WAC. "Date of receipt" is defined in RCW 43.21B.001(2).

To appeal you must do all of the following within 30 days of the date of receipt of this Order:

- File your appeal and a copy of this Order with the PCHB (see addresses below). Filing means actual receipt by the PCHB during regular business hours.
- Serve a copy of your appeal and this Order on Ecology in paper form - by mail or in person (see addresses below). E-mail is not accepted.

You must also comply with other applicable requirements in chapter 43.21B RCW and chapter 371-08 WAC.

ADDRESS AND LOCATION INFORMATION

Street Addresses	Mailing Addresses
<p>Department of Ecology Attn: Appeals Processing Desk 300 Desmond Drive SE Lacey, WA 98503</p> <p>Pollution Control Hearings Board 1111 Israel RD SW STE 301 Tumwater, WA 98501</p>	<p>Department of Ecology Attn: Appeals Processing Desk PO Box 47608 Olympia, WA 98504-7608</p> <p>Pollution Control Hearings Board PO Box 40903 Olympia, WA 98504-0903</p>

CONTACT INFORMATION

Please direct all questions about this Order to:

Noel Tamboer
 Department of Ecology
 P.O. Box 47600
 Olympia, WA 98503-7600
 (360) 701-6171
noel.tamboer@ecy.wa.gov

9.10.4 WAR10I000 Indian country within the State of Washington

a. Lummi Nation

- i. This certification does not exempt and is provisional upon compliance with other applicable statutes and codes administered by federal and Lummi tribal agencies. Pursuant to Lummi Code of Laws (LCL) 17.05.020(a), the operator must also obtain a land use permit from the Lummi Planning Department as provided in Title 15 of the Lummi Code of Laws and regulations adopted thereunder.
 - ii. Pursuant to LCL 17.05.020(a), each operator shall develop and submit a Storm Water Pollution Prevention Plan to the Lummi Water Resources Division for review and approval by the Water Resources Manager prior to beginning any discharge activities.
 - iii. Pursuant to LCL Title 17, each operator shall be responsible for achieving compliance with the Water Quality Standards for Surface Waters of the Lummi
 - iv. Indian Reservation (Lummi Administrative Regulations [LAR] 17 LAR 07.010 through 17 LAR 07.210 together with supplements and amendments thereto).
 - v. Each operator shall submit a signed copy of the Notice of Intent (NOI) to the Lummi Water Resources Division at the same time it is submitted electronically to the Environmental Protection Agency (EPA) and shall provide the Lummi Water Resources Division the acknowledgement of receipt of the NOI from the EPA and the associated NPDES tracking number provided by the EPA within 7 calendar days of receipt from the EPA.
 - vi. Each operator shall submit a signed copy of the Notice of Termination (NOT) to the Lummi Water Resources Division at the same time it is submitted electronically to the EPA and shall provide the Lummi Water Resources Division the EPA acknowledgement of receipt of the NOT.
 - vii. Storm Water Pollution Prevention Plans, Notice of Intent, Notice of Termination and associated correspondence with the EPA shall be submitted to:
 - Lummi Natural Resources Department
 - ATTN: Water Resources Manager 2665 Kwina Road
 - Bellingham, WA 98226-9298
- b. Port Gamble S'Klallam Tribe**
- i. No discharge from the project site shall cause exceedances of Port Gamble S'Klallam Surface Water Quality Standards narrative or numeric criteria in Tribal waters. This includes activities outside of Tribal lands that occur upstream of Tribal waters.
 - (a) If any exceedance of these water quality standards occurred, the Natural Resources Department shall be notified immediately.
 - The Department shall additionally be provided a complete draft of the proposed corrective action within a reasonable timeframe and its approval will be required before any corrective action may be taken.
 - ii. Operators performing activities under the CGP that may affect Tribal waters will require a permit and shall submit their plans to the Port Gamble S'Klallam Natural Resources Department for review.
 - The Department has the right to require conditions outside of this Water Quality Certification prior to permit approval.
 - iii. No activities allowed under the CGP shall result in the degradation of any Tribal

waters or change in designated uses.

- iv. No activities allowed under the CGP shall affect resident aquatic communities or resident/migratory wildlife species at any life stage.
 - Biological assessment methods used to determine the effect of an activity allowed under the CGP shall be approved by the PGST Natural Resources Department.
- v. No activities allowed under the CGP shall be conducted within wetland and stream buffer zones, nor shall said activities affect in any way wetland or stream buffers, as defined by *PGST Law and Order Code 24.08.01(c)*.
- vi. Concentrations for substances listed within the table in *Water Quality Standards for Surface Waters sec. 7(7)* shall not be exceeded by activities allowed under the CGP.

c. Spokane Tribe of Indians

- i. Pursuant to Tribal Law and Order Code (TLOC) Chapter 30 each operator shall be responsible for achieving compliance with the Surface Water Quality Standards of the Spokane Tribe. The operator shall notify the Spokane Tribe, Water Control Board (WCB) of any spills of hazardous material and;
- ii. Each operator shall submit a signed hard copy of the Notice of Intent (NOI) to the WCB at the same time it is submitted to EPA.
- iii. The permittee shall allow the Tribal Water Control Board or its designee to inspect and sample at the construction site as needed.
- iv. Each operator shall submit a signed copy of the Notice of Termination (NOT) to the WCB at the same time it is submitted to EPA

The correspondence address for the Spokane Tribe Water Control Board is:

Water Control Board c/o Brian Crossley PO Box 480
 Wellpinit WA 99040
 (509) 626-4409
 crossley@spokanetribe.com

d. Swinomish Tribe

- i. Owners and operators seeking coverage under this permit must submit a copy of the Notice of Intent (NOI) to the DEP at the same time the NOI is submitted to EPA.
- ii. Owners and operators must also submit to the DEP changes in NOI and/or Notices of Termination at the same time they are submitted to EPA.
- iii. Owners and operators seeking coverage under this permit must also submit a Stormwater Pollution Prevention Plan to the DEP for review and approval by DEP prior to beginning any discharge activities.

e. Tulalip Tribes

- i. Submission of NOI: Copies of the Notice of Intent (NOI), Certification shall be submitted to the Tribe's Natural Resources Department to notify the Tribes of the pending project and in order for the Tribes to review the projects potential impacts to endangered or threatened species.

- ii.** Submission of SWPPP: A copy of the Stormwater Pollution Plans (SWPPPs) shall be submitted to the Tribe's Natural Resources Department along with the NOI during the 30 day waiting period.
- iii.** Submission of Monitoring Data and Reports: The results of any monitoring required by this permit and reports must be sent to the Tribe's Natural Resources Department,
- iv.** The Tulalip Tribes are federally recognized successors in the interest to the Snohomish, Snoqualmie, Skykomish, and other allied tribes and bands signatory to the Treaty of Point Elliott.
- v.** including a description of the corrective actions required and undertaken to meet effluent limits or benchmarks (as applicable).
- vi.** Authorization to Inspect: The Tribe's Natural Resources Department may conduct an inspection of any facility covered by this permit to ensure compliance with tribal water quality standards. The Department may enforce its certification conditions.
- vii.** Submission of Inspection Reports: Inspection reports must be sent to the Tribe's Natural Resources Department, including a description of the corrective actions required and undertaken to meet effluent limits or benchmarks (as applicable).
- viii.** Permits on-site: A copy of the permit shall be kept on the job site and readily available for reference by the construction supervisor, construction managers and foreman, and Tribal inspectors.
- ix.** Project Management: The applicant shall ensure that project managers, construction managers and foreman, and other responsible parties have read and understand conditions of the permit, this certification, and other relevant documents, to avoid violations or noncompliance with this certification.
- x.** Emergency Spill Notification Requirements: In the event of a spill or the contractor shall immediately take action to stop the violation and correct the problem, and immediately report spill to the Tulalip Tribes Police Department (425) 508-1565. Compliance with this condition does not relieve the applicant from responsibility to maintain continuous compliance with the terms and conditions of this certification or the resulting liability from failure to comply.
- xi.** Discharges to CERCLA Sites: This permit does not authorize direct stormwater discharges to certain sites undergoing remedial cleanup actions pursuant to the Comprehensive Environmental Response, Compensation and Liability Act (CERCLA) unless first approved by the appropriate EPA Regional office. In the case of the Tulalip Landfill site (WAD980639256), the Tulalip Tribes also requests notification by the facility and consultation with EPA prior to discharge. Contaminants at this site may include but are not limited to: dioxins, furans, arsenic, copper, lead, zinc, 4-methyl-phenol, Hex-CB, HPAHs, PCBs, PCE, cadmium, mercury, and LPAHs.
- xii.** Discharge-related Activities that have Potential to Cause an Adverse Effect on Historic Properties: Installation of stormwater controls that involve subsurface disturbances may potentially have an adverse impact on historic properties.
- xiii.** Procedures detailed in the permit shall be completed. Richard Young, of the Tulalip Tribe's Cultural Resources Department shall be contacted prior to initiating

discharge-related activities that may have an impact on historic properties. His contact information is (360) 716-2652, ryoung@tulaliptribes-nsn.gov.

- xiv.** Invalidation: This certification will cease to be valid if the project is constructed and/or operated in a manner not consistent with the project description contained in
- xv.** the permit. This certification will also cease to be valid and the applicant must reapply with an updated application if information contained in the permit is voided by subsequent submittals.
- xvi.** Modification: Nothing in this certification waives the Tulalip Tribes of Washington's authority to issue modifications to this certification if additional impacts due to operational changes are identified, or if additional conditions are necessary to protect water quality or further protect the Tribal Communities interest.
- xvii.** incorporation by reference: This certification does not exempt the applicant from compliance with other statutes and codes administered by the Tribes, county, state and federal agencies.
- xviii.** Compliance with Tribe's 1996 Water Quality Standards: Each permittee shall be responsible for controlling discharges and achieving compliance with the Tribe's Water Quality Standards.
- xix.** Compliant with Tulalip Tribes Tidelands Management Policy: Permittee shall be responsible for achieving compliance with applicable sections of the Tulalip Tribe's Tidelands Management Policy. (Tulalip Tribal Code Title 8 Chapter 8.30).
- xx.** Compliant with Tulalip Tribes Environmental Infractions: Permittee shall be responsible for achieving compliance with applicable sections of the Tulalip Tribe's Environmental Infractions. (Tulalip Tribal Code Title 8 Chapter 8.20).
- xxi.** Where to Submit information and for further Coordination: All requested documents should be sent to the: Tulalip Tribes Natural Resources Environmental Department c/o Kurt Nelson and Valerie Streeter, 6704 Marine Drive, Tulalip, Washington 98271. For further 401 Certification coordination with the Tulalip Tribes Natural Resources Department, please contact Mr. Kurt Nelson (360) 716-4617 knelson@tulaliptribes-nsn.gov. 6406 Marine Dr., Tulalip WA 98271.

f. Makah Tribe

- i.** The permittee shall be responsible for meeting any additional permit requirements imposed by EPA necessary to comply with the Makah Tribe's Water Quality Standards if the discharge point is located within the Makah's U&A treaty reserved areas.
- ii.** Each permittee shall submit a copy of the Notice of Intent (NOI) to be covered by the general permit to Makah Fisheries Management, Water Quality Department at the address listed below at the same time it is submitted to the EPA.

Makah Water Quality
Makah Fisheries Management (MFM)
ray.colby@makah.com
PO Box 115
Neah bay, WA 98357

- iii. All supporting documentation and certifications in the NOI related to coverage under the general permit for Endangered Species Act purposes shall be submitted to the Tribe's Habitat programs for their review.
 - iv. If EPA requires coverage under an individual or alternative permit, the permittee shall submit a copy of the permit to Assistant Fisheries Director, ray.colby@makah.com.
 - v. The permittee shall submit all Stormwater Pollution Prevention plan (SWPP) to MFM for review and approval prior to beginning any activities resulting in a discharge to Makah tribal waters.
 - vi. The permittee shall notify Ray Colby, ray.colby@makah.com (360) 645-3150 prior to conducting inspections at construction sites generating stormwater discharges to tribal waters.
 - vii. The operator shall treat dewatering discharges with controls necessary to minimize discharges of pollutants to surface waters, or ground waters, and from stormwater runoff onsite from excavations, trenches, foundations, or storage areas. To the extent feasible, at all points where dewatering is discharged, comply with the velocity dissipation using check dams, sediment traps, and grouted outlets.
- g. Puyallup Tribe of Indians**
- i. The permittee shall be responsible for meeting any additional permit requirements imposed by EPA necessary to comply with the Puyallup Tribe's antidegradation procedures.
 - ii. Each permittee shall submit a copy of the Notice of Intent (NOI) to be covered by the general permit to Char Naylor, Tribal Water Quality Manager at the following e-mail address: (char.naylor@puyalluptribe-nsn.gov) at the same time it is submitted to EPA.
 - iii. All supporting documentation and certifications in the NOI related to coverage under the general permit for Endangered Species Act purposes shall be submitted to Char Naylor, Tribal Water Quality Manager/Assistant Fisheries Director (char.naylor@puyalluptribe-nsn.gov) for review.
 - iv. If EPA requires coverage under an individual or alternative permit, the permittee shall submit a copy of the permit to Char Naylor at the email address listed above.
 - v. The permittee shall submit all stormwater pollution prevention plans to Char Naylor for review and approval prior to beginning any activities resulting in a discharge to Puyallup tribal waters.
 - vi. The permittee shall contact Brandon Reynon (Brandon.reynon@puyalluptribe-nsn.gov), Tribe's Historic Preservation Officer or Jennifer Keating (Jennifer.keating@puyalluptribe-nsn.gov), Tribe's Assistant Historic Preservation Officer regarding historic properties and cultural resources.
 - vii. To minimize the discharge of pollutants to groundwater or surface waters from stormwater that is removed from excavations, trenches, foundations, vaults, or other storage areas, treat dewatering discharges with controls necessary to minimize discharges of pollutants. Examples of appropriate controls include sediment basins or sediment traps, sediment socks, dewatering tanks, tube

settlers, weir tanks, and filtration systems (e.g., bag or sand filters) that are designed to remove sediment.

To the extent feasible, utilize vegetated, upland areas of the site to infiltrate dewatering water before discharge. At all points where dewatering water is discharged, utilize velocity dissipation controls. Examples of velocity dissipation devices include check dams, sediment traps, riprap, and grouted riprap at outlets.

- viii.** The permittee shall provide and maintain natural buffers to the maximum extent possible (and/or equivalent erosion and sediment controls) when tribal waters are located within 100 feet of the boundaries. If infeasible to provide and maintain an undisturbed 100 foot natural buffer, erosion and sediment controls to achieve the sediment load reduction equivalent to a 100-foot undisturbed natural buffer shall be required.

10 ADDITIONAL PERMIT CONDITIONS APPLICABLE TO LANDS OF EXCLUSIVE FEDERAL JURISDICTION

All projects that discharge to receiving waters located within Lands of Exclusive Federal Jurisdiction must comply with the provisions in this Part in addition to Parts 1, 2, and 3.2 thru 8 of this permit.^{110 111 112}

10.1 INSPECTION FREQUENCIES

You must comply with the increased inspection frequencies specified in Part 4.3.1.

10.2 STABILIZATION DEADLINES

You must comply with the stabilization deadlines specified in Part 2.2.14b.iv.

10.3 TURBIDITY BENCHMARK MONITORING FOR DEWATERING DISCHARGES

You must comply with the benchmark monitoring requirements in Part 3.3 for sites discharging dewatering water.

10.4 ADDITIONAL WATER QUALITY-BASED LIMITATIONS FOR STORMWATER AND AUTHORIZED NON-STORMWATER DISCHARGES

Your discharge must not contain:

- a.** Observable deposits of floating solids, scum, sheen, or other substances;
- b.** An observable film, sheen, or discoloration from oil and grease; or
- c.** Foam or substances that produce an observable change in color, odor, or cloudiness in the discharge.

¹¹⁰ The requirements of Part 9 do not apply to projects within Lands of Exclusive Federal Jurisdiction.

¹¹¹ This section does not apply to projects within Denali National Park and Preserve or projects that are eligible for coverage in Appendix B for federal facilities in Vermont, Delaware, and Colorado and for areas in Washington where construction activities are carried out by a Federal Operator.

¹¹² EPA notes that reference to water quality standards in Part 7.2.6(b)(vi)(c) for projects that discharge to receiving waters in Lands of Exclusive Federal Jurisdiction means the requirements of Part 10.4.a-c.

If any of these conditions are observed, except with respect to dewatering discharges, you must treat this as triggering corrective action under Part 5, which requires that you take corrective action and document the corrective actions as required in Part 5.2.¹¹³

For sites discharging from dewatering operations, you must implement corrective actions if any of the conditions described in Part 5.1.5 occur and comply with the requirements of Part 5.2.2 for responding to these conditions.

¹¹³ Consistent with this requirement, with respect to projects discharging to receiving waters in Lands of Exclusive Federal Jurisdiction, the triggering condition in Part 5.1.3 relating to water quality standards means that one of the discharge conditions in this section (Part 10.4.a-c) has occurred.

Appendix C – Copy of NOI and EPA Authorization Email

Doug Jones

From: no-reply@epacdx.net
Sent: Friday, January 9, 2026 1:37 PM
Subject: EPA NeT CGP Forms Certified: Take 5 Oil Change Gibson ABQ DD, NPDES ID: NMR1007NZ

2026-01-09

Dear NeT User,

Stephen Knudsen successfully certified the following forms within NeT CGP:

NPDES ID	Form Type	Operator	Project/Site Name	City, State	Targeted End of Review
NMR1007NZ	NOI	Durban Development	Take 5 Oil Change Gibson ABQ DD	Albuquerque , NM	01/23/2026

A copy of the submission can be found [here](#).

If your NOI or Change-NOI is subject to review, your coverage under the CGP begins at the conclusion of the 14-day waiting period, unless otherwise notified that your coverage has been delayed or denied. You will receive an email informing you once your coverage under the CGP is active.

Additionally you can view your submission history and obtain a copy of the form you submitted within the NPDES Electronic Reporting Tool (NeT) or download via [Permit Search](#).

If you were the certifier of this form, a copy of your submission is also available on the Submission History tab of your EPA Central Data Exchange (CDX) account. If you have questions about this email or about NeT CGP, please refer to [NeT Support](#) or e-mail NPDESereporting@epa.gov for assistance.

This is an automated notification; please do not reply to this email.

Doug Jones

From: no-reply@epacdx.net
Sent: Friday, January 9, 2026 1:40 PM
Subject: EPA NeT CGP Forms Certified: Take 5 Oil Change Gibson ABQ, NPDES ID: NMR100700

2026-01-09

Dear NeT User,

Stephen Knudsen successfully certified the following forms within NeT CGP:

NPDES ID	Form Type	Operator	Project/Site Name	City, State	Targeted End of Review
NMR100700	NOI	Albuquerque-Gibson Take Five, LLC	Take 5 Oil Change Gibson ABQ	Albuquerque , NM	01/23/2026

A copy of the submission can be found [here](#).

If your NOI or Change-NOI is subject to review, your coverage under the CGP begins at the conclusion of the 14-day waiting period, unless otherwise notified that your coverage has been delayed or denied. You will receive an email informing you once your coverage under the CGP is active.

Additionally you can view your submission history and obtain a copy of the form you submitted within the NPDES Electronic Reporting Tool (NeT) or download via [Permit Search](#).

If you were the certifier of this form, a copy of your submission is also available on the Submission History tab of your EPA Central Data Exchange (CDX) account. If you have questions about this email or about NeT CGP, please refer to [NeT Support](#) or e-mail NPDESereporting@epa.gov for assistance.

This is an automated notification; please do not reply to this email.

Appendix D – Copy of Site and Dewatering Inspection Forms

(Note: EPA has developed a sample site inspection and dewatering inspection form templates that CGP operators can use. The template is available at <https://www.epa.gov/npdes/construction-general-permit-resources-tools-and-templates>)

Section A – Dewatering Discharges (CGP Part 4.6.3) Complete this section <u>within 24 hours</u> of completing the inspection. (If necessary, complete additional inspection reports for each separate inspection location.)	
Inspector Information	
Inspector Name:	Title:
Company Name:	Email:
Address:	Phone Number:
Inspection Details	
Inspection Date:	Inspection Location:
Discharge Start Time:	Discharge End Time:
Rate of Discharge (gallons per day):	Corrective Action Required? ¹ <input type="checkbox"/> Yes <input type="checkbox"/> No
Describe Indicators of Pollutant Discharge at Point of Dewatering Discharge: ¹	
Attach Photographs of: <ol style="list-style-type: none"> 1. Dewatering water prior to treatment by a dewatering control(s) and the final discharge after treatment; and 2. Dewatering control(s); and 3. Point of discharge to any receiving waters flowing through or immediately adjacent to the site and/or to constructed or natural site drainage features, storm drain inlets, and other conveyances to receiving waters. 	

¹ If you observe any of the following indicators of pollutant discharge, you are required to take corrective action under Part 5.1.5.b:

- a sediment plume, suspended solids, unusual color, presence of odor, decreased clarity, or presence of foam; or
- a visible sheen on the water surface or visible oily deposits on the bottom or shoreline of the receiving water.

Section B – Signature and Certification (CGP Part 4.7.2)

"I certify under penalty of law that this document and all attachments were prepared under my direction or supervision in accordance with a system designed to assure that qualified personnel properly gathered and evaluated the information contained therein. Based on my inquiry of the person or persons who manage the system, or those persons directly responsible for gathering the information, the information contained is, to the best of my knowledge and belief, true, accurate, and complete. I have no personal knowledge that the information submitted is other than true, accurate, and complete. I am aware that there are significant penalties for submitting false information, including the possibility of fine and imprisonment for knowing violations."

MANDATORY: Signature of Operator or "Duly Authorized Representative:"

Signature:	Date:
-------------------	--------------

Printed Name:	Affiliation:
----------------------	---------------------

OPTIONAL: Signature of Contractor or Subcontractor

Signature:	Date:
-------------------	--------------

Printed Name:	Affiliation:
----------------------	---------------------

General Tips for Using This Template

This Dewatering Inspection Report Template is provided to assist you in preparing dewatering inspection reports for EPA's 2022 Construction General Permit (CGP). If you are covered under the 2022 CGP, you can use this template to create a dewatering inspection report form that complies with the minimum reporting requirements of Part 4.6.3 of the permit. Note that the use of this form is optional; you may use your own inspection report form provided it includes the minimum information required in Part 4.6.3 of the CGP.

This template is for dewatering inspections only. A separate site inspection report template that does not include dewatering inspections and complies with the minimum reporting requirements of Part 4.7 of the permit is available at <https://www.epa.gov/npdes/construction-general-permit-resources-tools-and-templates>.

If you are covered under a State CGP, this template may be helpful in developing a report that can be used for that permit; however, it will need to be modified to meet the specific requirements of that permit. If your permitting authority requires you to use a specific inspection report form, you should not use this form.

The following tips for using this template will help you ensure that the minimum permit requirements are met:

- **Review the inspection requirements.** Before you start developing your inspection report form, read the CGP's Part 4 inspection requirements. This will ensure that you have a working understanding of the permit's underlying inspection requirements.
- **Complete all required blank fields.** Fill out all blank fields. Only by filling out all fields will the template be compliant with the requirements of the permit. (Note: Where you do not need the number of rows provided in the template form for your inspection, you may delete these as you see fit. Or, if you need more space to document your findings, you may insert additional rows in the electronic version of this form or use the bottom of the page in the field version of this form.)
- **Use your site map to document inspection findings.** In several places in the template, you are directed to specify the location of certain features of your site, including where stormwater controls are installed and where you will be stabilizing exposed soil. You are also asked to fill in location information for unsafe conditions and the locations of any discharges occurring during your inspections. Where you are asked for location information, EPA encourages you to reference the point on your SWPPP site map that corresponds to the requested location on the inspection form. Using the site map as a tool in this way will help you conduct efficient inspections, will assist you in evaluating problems found, and will ensure proper documentation.
- **Include the inspection form with your SWPPP.** Once your form is complete, make sure to include a copy of the inspection form in your SWPPP in accordance with Part 7.2.7.e of the CGP.
- **Retain copies of all inspection reports with your records.** You must also retain copies of all inspection reports in your records in accordance with the requirements in Part 4.7.3 of the CGP. These reports must be retained for at least 3 years from the date your permit coverage expires or is terminated in accordance with the requirements in Part 4.7.4 of the CGP.

Instructions for Section A

Inspector Name

Enter the name of the person that conducted the inspection. Include the person's contact information (title, affiliated company name, address, email, and phone number).

Inspection Date

Enter the date you performed the inspection.

Inspection Location

If your project has multiple locations where you conduct separate dewatering inspections, specify the location where this inspection is being conducted. Otherwise, you can enter "dewatering operation."

Discharge Start and End Times

Enter the approximate time the dewatering discharge started and ended on the day of the inspection.

Rate of Discharge

Enter the rate of discharge in gallons per day on the day of inspection.

To estimate the approximate discharge rate on the day of dewatering inspection, one approach is to use the manufacturer's design pump rating for the pump model in use. For example, a pump rated at 164 gpm (gallons per minute) by the manufacturer can be assumed to be discharging at 164 gpm in most cases. To convert to gallons per day, multiply the rate in gpm by the ratio of minutes in one-day (1,440 minutes per day), resulting in a discharge rate of 236,160 gallons per day.

In cases where the dewatering discharge is being pumped over long distances or a substantial distance uphill, which will result in a reduced pump rate relative to manufacturer's specification, the operator may improve the accuracy of the estimate by estimating the time required to fill a container of a known volume. For example, if it takes 60 seconds to fill an empty 55-gallon barrel, the estimated discharge rate is 55 gpm, or 79,200 gallons per day.

Indicators of Pollutant Discharge

For the point of discharge, describe any observed sediment plume, suspended solids, unusual color, presence of odor, decreased clarity, or presence of foam; and/or a visible sheen on the water surface or visible oily deposits on the bottom or shoreline of the receiving water.

Corrective Action Required?

Answer "Yes" if during your inspection you found any of the conditions listed above in the instructions for the Indicators of Pollutant Discharge section. If you answer "Yes," you must take corrective action and complete a corrective action log, found at <https://www.epa.gov/npdes/construction-general-permit-resources-tools-and-templates>. Answer "No" if you did not observe any of the listed pollutant indicators.

Photographs

As required in CGP Part 8.2.1.a, attach photos of: (1) dewatering water prior to treatment by a dewatering control(s) and the final discharge after treatment; (2) the dewatering control(s); and (3) the point of discharge to any receiving waters flowing through or immediately adjacent to the site and/or to constructed or natural site drainage features, storm drain inlets, and other conveyances to receiving waters.

Instructions for Section B

Each inspection report must be signed and certified to be considered complete (CGP Part 4.7.2).

Operator or "Duly Authorized Representative" – MANDATORY (CGP Appendix G Part G.11.2 and CGP Appendix H Section X)

At a minimum, the dewatering inspection report must be signed by either (1) the person who signed the NOI, or (2) a duly authorized representative of that person. The following requirements apply:

If the signatory will be the person who signed the NOI for permit coverage, as a reminder, that person must be one of the following types of individuals:

- *For a corporation:* By a responsible corporate officer. For the purpose of this subsection, a responsible corporate officer means: (i) a president, secretary, treasurer, or vice-president of the corporation in charge of a principal business function, or any other person who performs similar policy- or decision-making functions for the corporation, or (ii) the manager of one or more manufacturing, production, or operating facilities, provided, the manager is authorized to make management decisions which govern the operation of the regulated facility including having the explicit or implicit duty of making major capital investment recommendations, and initiating and directing other comprehensive measures to assure long term environmental compliance with environmental laws and regulations; the manager can ensure that the necessary systems are established or actions taken to gather complete and accurate information for permit application requirements; and where authority to sign documents has been assigned or delegated to the manager in accordance with corporate procedures.
- *For a partnership or sole proprietorship:* By a general partner or the proprietor, respectively.

- *For a municipality, State, Federal, or other public agency:* By either a principal executive officer or ranking elected official. For purposes of this subsection, a principal executive officer of a Federal agency includes (i) the chief executive officer of the agency, or (ii) a senior executive officer having responsibility for the overall operations of a principal geographic unit of the agency (e.g., Regional Administrator of EPA).

If the signatory will be a duly authorized representative, the following requirements must be met:

- The authorization is made in writing by the person who signed the NOI (see above);
- The authorization specifies either an individual or a position having responsibility for the overall operation of the regulated facility or activity such as the position of plant manager, operator of a well or a well field, superintendent, position of equivalent responsibility, or an individual or position having overall responsibility for environmental matters for the company. (A duly authorized representative may thus be either a named individual or any individual occupying a named position); and
- The signed and dated written authorization is included in the SWPPP. A copy must be submitted to EPA, if requested.

Sign, date and print your name and affiliation.

Contractor or Subcontractor - OPTIONAL

Where you rely on a contractor or subcontractor to complete the dewatering inspection report, you should consider requiring the individual(s) to sign and certify each report. Note that this does not relieve you, the permitted operator, of the requirement to sign and certify the dewatering inspection report as well. If applicable, sign, date, and print your name and affiliation.

Note

While EPA has made every effort to ensure the accuracy of all instructions contained in this template, it is the permit, not this template, that determines the actual obligations of regulated construction stormwater discharges. In the event of a conflict between this template and any corresponding provision of the CGP, you must abide by the requirements in the permit. EPA welcomes comments on this Dewatering Inspection Report Template at any time and will consider those comments in any future revision. You may contact EPA for CGP-related inquiries at cgp@epa.gov

Section A – General Information (If necessary, complete additional inspection reports for each separate inspection location.)	
Inspector Information	
Inspector Name:	Title:
Company Name:	Email:
Address:	Phone Number:
Inspection Details	
Inspection Date:	Inspection Location:
Inspection Start Time:	Inspection End Time:
Current Phase of Construction:	Weather Conditions During Inspection:
Did you determine that any portion of your site was unsafe for inspection per CGP Part 4.5? <input type="checkbox"/> Yes <input type="checkbox"/> No If "Yes," provide the following information: Location of unsafe conditions: The conditions that prevented you inspecting this location:	
Indicate the required inspection frequency: (Check all that apply. You may be subject to different inspection frequencies in different areas of the site.)	
Standard Frequency (CGP Part 4.2): <input type="checkbox"/> At least once every 7 calendar days; OR <input type="checkbox"/> Once every 14 calendar days <i>and</i> within 24 hours of the occurrence of either: <ul style="list-style-type: none"> • A storm event that produces 0.25 inches or more of rain within a 24-hour period, or • A snowmelt discharge from a storm event that produces 3.25 inches or more of snow within a 24-hour period 	
Increased Frequency (CGP Part 4.3.1) (If site discharges to sediment or nutrient-impaired waters or to waters designated as Tier 2, Tier 2.5, or Tier 3): <input type="checkbox"/> Once every 7 calendar days <i>and</i> within 24 hours of the occurrence of either: <ul style="list-style-type: none"> • A storm event that produces 0.25 inches or more of rain within a 24-hour period, or • A snowmelt discharge from a storm event that produces 3.25 inches or more of snow within a 24-hour period 	

Reduced Frequency (CGP Part 4.4):

- For stabilized areas: Twice during first month, no more than 14 calendar days apart; then once per month after first month until permit coverage is terminated
- For stabilized areas on "linear construction sites": Twice during first month, no more than 14 calendar days apart; then once more within 24 hours of the occurrence of either:
 - A storm event that produces 0.25 inches or more of rain within a 24-hour period, or
 - A snowmelt discharge from a storm event that produces 3.25 inches or more of snow within a 24-hour period
- For arid, semi-arid, or drought-stricken areas during seasonally dry periods or during drought: Once per month and within 24 hours of the occurrence of either:
 - A storm event that produces 0.25 inches or more of rain within a 24-hour period, or
 - A snowmelt discharge from a storm event that produces 3.25 inches or more of snow within a 24-hour period
- For frozen conditions where construction activities are being conducted: Once per month

Was this inspection triggered by a storm event producing 0.25 inches or more of rain within a 24-hour period? Yes No

If "Yes," how did you determine whether the storm produced 0.25 inches or more of rain?

- On-site rain gauge
- Weather station representative of site.
Weather station location:

Total rainfall amount that triggered the inspection (inches):

Was this inspection triggered by a snowmelt discharge from a storm event producing 3.25 inches or more of snow within a 24-hour period? Yes No

If "Yes," how did you determine whether the storm produced 3.25 inches or more of snow?

- On-site rain gauge
- Weather station representative of site.
Weather station location:

Total snowfall amount that triggered the inspection (inches):

Section B – Condition and Effectiveness of Erosion and Sediment (E&S) Controls (CGP Part 2.2) (Insert additional rows if needed)					
Type and Location of E&S Control	Conditions Requiring Routine Maintenance? ¹	If “Yes,” How Many Times (Including This Occurrence) Has This Condition Been Identified?	Conditions Requiring Corrective Action? ^{2, 3}	Date on Which Condition First Observed (If Applicable)?	Description of Conditions Observed
1.	<input type="checkbox"/> Yes <input type="checkbox"/> No		<input type="checkbox"/> Yes <input type="checkbox"/> No		
2.	<input type="checkbox"/> Yes <input type="checkbox"/> No		<input type="checkbox"/> Yes <input type="checkbox"/> No		
3.	<input type="checkbox"/> Yes <input type="checkbox"/> No		<input type="checkbox"/> Yes <input type="checkbox"/> No		
4.	<input type="checkbox"/> Yes <input type="checkbox"/> No		<input type="checkbox"/> Yes <input type="checkbox"/> No		
5.	<input type="checkbox"/> Yes <input type="checkbox"/> No		<input type="checkbox"/> Yes <input type="checkbox"/> No		
<p>If the same routine maintenance was found to be necessary three or more times for the same control at the same location (including this occurrence), follow the corrective action requirements and record the required information in your corrective action log, or describe here why you believe the specific condition should still be addressed as routine maintenance:</p>					

¹ Routine maintenance includes minor repairs or other upkeep performed to ensure that the site’s stormwater controls remain in effective operating condition, not including significant repairs or the need to install a new or replacement control. Routine maintenance is also required for specific conditions: (1) for perimeter controls, whenever sediment has accumulated to half or more the above-ground height of the control (CGP Part 2.2.3.c.i); (2) where sediment has been tracked-out from the site onto paved roads, sidewalks, or other paved areas (CGP Part 2.2.4.d); (3) for inlet protection measures, when sediment accumulates, the filter becomes clogged, and/or performance is compromised (CGP Part 2.2.10.b); and (4) for sediment basins, as necessary to maintain at least half of the design capacity of the basin (CGP Part 2.2.12.f)

² Corrective actions are triggered only for specific conditions (CGP Part 5.1):

1. A stormwater control needs a significant repair or a new or replacement control is needed, or, in accordance with Part 2.1.4.c, you find it necessary to repeatedly (i.e., three (3) or more times) conduct the same routine maintenance fix to the same control at the same location (unless you document in your inspection report under Part 4.7.1.c that the specific reoccurrence of this same problem should still be addressed as a routine maintenance fix under 2.1.4); or
2. A stormwater control necessary to comply with the requirements of this permit was never installed, or was installed incorrectly; or
3. Your discharges are not meeting applicable water quality standards; or
4. A prohibited discharge has occurred (see CGP Part 1.3); or
5. During the discharge from site dewatering activities:
 - a. The weekly average of your turbidity monitoring results exceeds the 50 NTU benchmark (or alternate benchmark if approved by EPA pursuant to Part 3.3.2.b); or
 - b. You observe or you are informed by EPA, State, or local authorities of the presence of the conditions specified in Part 4.6.3.e.

³ If a condition on your site requires a corrective action, you must also fill out a corrective action log found at <https://www.epa.gov/npdes/construction-general-permit-resources-tools-and-templates>. See CGP Part 5.4 for more information.

Section C – Condition and Effectiveness of Pollution Prevention (P2) Practices and Controls (CGP Part 2.3)					
(Insert additional rows if needed)					
Type and Location of P2 Practices and Controls	Conditions Requiring Routine Maintenance? ¹	If “Yes,” How Many Times (Including This Occurrence) Has This Condition Been Identified?	Conditions Requiring Corrective Action? ^{2,3}	Date on Which Condition First Observed (If Applicable)?	Description of Conditions Observed
1.	<input type="checkbox"/> Yes <input type="checkbox"/> No		<input type="checkbox"/> Yes <input type="checkbox"/> No		
2.	<input type="checkbox"/> Yes <input type="checkbox"/> No		<input type="checkbox"/> Yes <input type="checkbox"/> No		
3.	<input type="checkbox"/> Yes <input type="checkbox"/> No		<input type="checkbox"/> Yes <input type="checkbox"/> No		
4.	<input type="checkbox"/> Yes <input type="checkbox"/> No		<input type="checkbox"/> Yes <input type="checkbox"/> No		
5.	<input type="checkbox"/> Yes <input type="checkbox"/> No		<input type="checkbox"/> Yes <input type="checkbox"/> No		
<p>If the same routine maintenance was found to be necessary three or more times for the same control at the same location (including this occurrence), follow the corrective action requirements and record the required information in your corrective action log, or describe here why you believe the specific condition should still be addressed as routine maintenance:</p>					

Section D – Stabilization of Exposed Soil (CGP Part 2.2.14) (Insert additional rows if needed)					
Specific Location That Has Been or Will Be Stabilized	Stabilization Method and Applicable Deadline	Stabilization Initiated?	Final Stabilization Criteria Met?	Final Stabilization Photos Taken?	Notes
1.		<input type="checkbox"/> Yes <input type="checkbox"/> No If "Yes," date initiated:	<input type="checkbox"/> Yes <input type="checkbox"/> No If "Yes," date criteria met:	<input type="checkbox"/> Yes <input type="checkbox"/> No	
2.		<input type="checkbox"/> Yes <input type="checkbox"/> No If "Yes," date initiated:	<input type="checkbox"/> Yes <input type="checkbox"/> No If "Yes," date criteria met:	<input type="checkbox"/> Yes <input type="checkbox"/> No	
3.		<input type="checkbox"/> Yes <input type="checkbox"/> No If "Yes," date initiated:	<input type="checkbox"/> Yes <input type="checkbox"/> No If "Yes," date criteria met:	<input type="checkbox"/> Yes <input type="checkbox"/> No	
4.		<input type="checkbox"/> Yes <input type="checkbox"/> No If "Yes," date initiated:	<input type="checkbox"/> Yes <input type="checkbox"/> No If "Yes," date criteria met:	<input type="checkbox"/> Yes <input type="checkbox"/> No	
5.		<input type="checkbox"/> Yes <input type="checkbox"/> No If "Yes," date initiated:	<input type="checkbox"/> Yes <input type="checkbox"/> No If "Yes," date criteria met:	<input type="checkbox"/> Yes <input type="checkbox"/> No	

Section E – Description of Discharges (CGP Part 4.6.2) (Insert additional rows if needed)	
<p>Was a discharge (not including dewatering) occurring from any part of your site at the time of the inspection?⁴ <input type="checkbox"/> Yes <input type="checkbox"/> No</p> <p>If “Yes,” for each point of discharge, document the following:</p> <ul style="list-style-type: none"> • The visual quality of the discharge. • The characteristics of the discharge, including color; odor; floating, settled, or suspended solids; foam; oil sheen; and other indicators of stormwater pollutants. • Signs of the above pollutant characteristics that are visible from your site and attributable to your discharge in receiving waters or in other constructed or natural site drainage features. 	
Discharge Location	Observations
1.	
2.	
3.	
4.	
5.	

⁴ If a dewatering discharge was occurring, you must conduct a dewatering inspection pursuant to CGP Part 4.3.2 and complete a separate dewatering inspection report.

Section F – Signature and Certification (CGP Part 4.7.2)

"I certify under penalty of law that this document and all attachments were prepared under my direction or supervision in accordance with a system designed to assure that qualified personnel properly gathered and evaluated the information contained therein. Based on my inquiry of the person or persons who manage the system, or those persons directly responsible for gathering the information, the information contained is, to the best of my knowledge and belief, true, accurate, and complete. I have no personal knowledge that the information submitted is other than true, accurate, and complete. I am aware that there are significant penalties for submitting false information, including the possibility of fine and imprisonment for knowing violations."

MANDATORY: Signature of Operator or "Duly Authorized Representative:"

Signature:	Date:
Printed Name:	Affiliation:

OPTIONAL: Signature of Contractor or Subcontractor

Signature:	Date:
Printed Name:	Affiliation:

General Tips for Using This Template

This Site Inspection Report Template is provided to assist you in preparing site inspection reports for EPA's 2022 Construction General Permit (CGP). If you are covered under the 2022 CGP, you can use this template to create a site inspection report form that is customized to the specific circumstances of your site and that complies with the minimum reporting requirements of Part 4.7 of the permit. Note that the use of this form is optional; you may use your own site inspection report form provided it includes the minimum information required in Part 4.7 of the CGP.

This template does not address the CGP's inspection reporting requirements related to dewatering activities. A separate inspection template has been developed specifically for dewatering activities and is available at <https://www.epa.gov/npdes/construction-general-permit-resources-tools-and-templates>.

Keep in mind that this document is a template and not an "off-the-shelf" inspection report that is ready to use without some modification. You must first customize this form to include the specifics of your project in order for it to be useable for your inspection reports. Once you have entered all of your site-specific information into the blank fields, you may use this form to complete inspection reports.

The following tips for using this template will help you ensure that the minimum permit requirements are met:

- **Review the inspection requirements.** Before you start developing your inspection report form, read the CGP's Part 4 inspection requirements. This will ensure that you have a working understanding of the permit's underlying inspection requirements.
- **Complete all required blank fields.** Fill out all blank fields. Only by filling out all fields will the template be compliant with the requirements of the permit. (Note: Where you do not need the number of rows provided in the template form for your inspection, you may delete these or cross them off as you see fit. Or, if you need more space to document your findings, you may insert additional rows in the electronic version of this form or use the bottom of the page in the field version of this form.)
- **Use your site map to document inspection findings.** In several places in the template, you are directed to specify the location of certain features of your site, including where stormwater controls are installed and where you will be stabilizing exposed soil. You are also asked to fill in location information for unsafe conditions and the locations of any discharges occurring during your inspections. Where you are asked for location information, EPA encourages you to reference the point on your SWPPP site map that corresponds to the requested location on the inspection form. Using the site map as a tool in this way will help you conduct efficient inspections, will assist you in evaluating problems found, and will ensure proper documentation.
- **Complete the inspection report within 24 hours of completing a site inspection.** You must complete an inspection report in accordance with Part 4.7.1 of the CGP.
- **Include the inspection form with your SWPPP.** Once your form is complete, make sure to include a copy of the inspection form in your SWPPP in accordance with Part 7.2.7.e of the CGP.
- **Retain copies of all inspection reports with your records.** You must also retain in your records copies of all inspection reports in accordance with the requirements in Part 4.7.3 of the CGP. These reports must be retained for at least 3 years from the date your permit coverage expires or is terminated in accordance with the requirements in Part 4.7.4 of the CGP.

Instructions for Section A

Inspector Name

Enter the name of the person that conducted the inspection. Include the person's contact information (title, affiliated company name, address, email, and phone number).

Inspection Date and Time

Enter the date you performed the inspection and the time you started and ended the inspection.

Weather Conditions During Inspection

Enter the weather conditions occurring during the inspection, e.g., sunny, overcast, light rain, heavy rain, snowing, icy, windy.

Current Phase of Construction

If this project is being completed in more than one phase, indicate which phase it is currently in.

Inspection Location

If your project has multiple locations where you conduct separate inspections, specify the location where this inspection is being conducted. If only one inspection is conducted for your entire project, enter "Entire Site." If necessary, complete additional inspection report forms for each separate inspection location.

Unsafe Conditions for Inspection (CGP Part 4.5.7)

Inspections are not required where a portion of the site or the entire site is subject to unsafe conditions. These conditions should not regularly occur and should not be consistently present on a site. Generally, unsafe conditions are those that render the site (or a portion of it) inaccessible or that would pose a significant probability of injury to applicable personnel. Examples could include severe storm or flood conditions, high winds, and downed electrical wires.

If your site, or a portion of it, is affected by unsafe conditions during the time of your inspection, provide a description of the conditions that prevented you from conducting the inspection and what parts of the site were affected. If the entire site was considered unsafe, specify the location as "Entire Site."

Inspection Frequency

Check all the inspection frequencies that apply to your project. Note that you may be subject to different inspection frequencies in different areas of your site.

Inspection Triggered by a Storm Event

If you were required to conduct this inspection because of a storm event that produced 0.25 inches or more of rain within a 24-hour period, indicate whether you relied on an on-site rain gauge or a nearby weather station (and where the weather station is located). Also, specify the total amount of rainfall for this specific storm event.

If you were required to conduct this inspection because of a snowmelt discharge from a storm event that produced 3.25 inches or more of snow within a 24-hour period, then indicate whether you relied on an on-site measurement or a nearby weather station (and where the weather station is located). Also, specify the total amount of snowfall for this specific storm event.

Instructions for Section B

Type and Location of Erosion and Sediment (E&S) Controls

Provide a list of all erosion and sediment (E&S) controls that your SWPPP indicates will be installed and implemented at your site. This list must include at a minimum all E&S controls required by CGP Part 2.2. Include also any natural buffers established under CGP Part 2.2.1. Buffer requirements apply if your project's earth-disturbing activities will occur within 50 feet of a discharge to receiving water. You may group your E&S controls on your form if you have several of the same type of controls (e.g., you may group "Inlet Protection Measures," "Perimeter Controls," and "Stockpile Controls" together on one line), but if there are any problems with a specific control, you must separately identify the location of the control, whether routine maintenance or corrective action is necessary, and in the notes section you must describe the specifics about the problem you observed.

Conditions Requiring Routine Maintenance?

Answer "Yes" if the E&S control requires routine maintenance as defined in footnote 1 of this template. Note that in many cases, "Yes" answers are expected and indicate a project with an active operation and maintenance program. You should also answer "Yes" if work to fix the problem is still ongoing from the previous inspection, though necessary work must be initiated immediately and completed by the end of the next business day or within seven calendar days if documented in accordance with CGP Part 2.1.4.b.

If "Yes," How Many Times (Including this Occurrence) Has this Condition Been Identified?

Indicate how many times the routine maintenance has been required for the same control at the same location.

Conditions Requiring Corrective Action?

Answer "Yes" if you found any of the conditions listed in footnote 2 in this template to be present during your inspection (CGP Part 5.1). If you answer "Yes," you must take corrective action and complete a corrective action log, found at <https://www.epa.gov/npdes/construction-general-permit-resources-tools-and-templates>. You should also answer "Yes" if work to fix the problem from a previous inspection is still ongoing, though the operator must comply with the corrective action deadlines in CGP Part 5.2.

Date on Which Condition First Observed (If Applicable)?

Provide the date on which the condition that triggered the need for routine maintenance or corrective action was first identified. If the condition was just discovered during this inspection, enter the inspection date. If the condition is a carryover from a previous inspection, enter the original date of the condition's discovery.

Description of Conditions Observed

For each E&S control and the area immediately surrounding it, describe whether the control is properly installed and whether it appears to be working to minimize sediment discharge. Indicate also whether a new or modified control is necessary to comply with the permit. Describe any problem condition(s) you observed such as the following:

1. Failure to install or to properly install a required E&S control
2. Damage or destruction to an E&S control caused by vehicles, equipment, or personnel, a storm event, or other event
3. Mud or sediment deposits found downslope from E&S controls, including in receiving waters, or on nearby streets, curbs, or open conveyance channels
4. Sediment tracked out onto paved areas by vehicles leaving construction site
5. Noticeable erosion or sedimentation at discharge outlets or at adjacent streambanks or channels
6. Erosion of the site's sloped areas (e.g., formation of rills or gullies)
7. E&S control is no longer working due to lack of maintenance
8. Other incidents of noncompliance

Describe also why you think the problem condition(s) occurred as well as actions (e.g., routine maintenance or corrective action) you will take or have taken to fix the problem.

For buffer areas, make note of whether they are marked off as required, whether there are signs of construction disturbance within the buffer, which is prohibited under the CGP, and whether there are visible signs of erosion resulting from discharges through the area.

If routine maintenance or corrective action is required, briefly note the reason. If routine maintenance or corrective action has been completed, make a note of the date it was completed and what was done. *If corrective action is required, note that you will need to complete a separate corrective action log describing the condition and your work to fix the problem.*

Routine Maintenance Need Has Been Found to be Necessary Three (3) or More Times for the Same Control at the Same Location (Including this Occurrence)

If routine maintenance has been required three (3) or more times for the same control at the same location, the permit requires (CGP Part 2.1.4.c) you to fix the problem using the corrective action procedures in CGP Part 5 or to document why you believe the reoccurring problem can be addressed as a routine maintenance fix. If you believe the problem can continue to be fixed as routine maintenance, describe why you believe the specific condition should still be addressed as routine maintenance.

Instructions for Section C

Type and Location of Pollution Prevention (P2) Practices and Controls

Provide a list of all pollution prevention (P2) practices and controls that are implemented at your site. This list must include all P2 practices and controls required by CGP Part 2.3 and those that are described in your SWPPP.

Conditions Requiring Routine Maintenance?

Answer "Yes" if the P2 practice or control requires routine maintenance as defined in footnote 1 of this template. Note that in many cases, "Yes" answers are expected and indicate a project with an active operation and maintenance program. You should also answer "Yes" if work to fix the problem is still ongoing

from the previous inspection, though necessary work must be initiated immediately and completed by the end of the next business day or within seven calendar days if documented in accordance with CGP Part 2.1.4.b.

If “Yes,” How Many Times (Including this Occurrence) Has this Condition Been Identified?

Indicate how many times the routine maintenance has been required for the same practice or control at the same location.

Conditions Requiring Corrective Action?

Answer “Yes” if you found any of the conditions listed in footnote 2 in this template to be present during your inspection (CGP Part 5.1). If you answer “Yes,” you must take corrective action and complete a corrective action log, found at <https://www.epa.gov/npdes/construction-general-permit-resources-tools-and-templates>. You should also answer “Yes” if work to fix the problem from a previous inspection is still ongoing, though the operator must comply with the corrective action deadlines in CGP Part 5.2.

Date on Which Condition First Observed (If Applicable)?

Provide the date on which the condition that triggered the need for maintenance or corrective action was first identified. If the condition was just discovered during this inspection, enter the inspection date. If the condition is a carryover from a previous inspection, enter the original date of the condition’s discovery.

Description of Conditions Observed

For each P2 control and the area immediately surrounding it, describe whether the control is properly installed, and whether it appears to be working to minimize or eliminate pollutant discharges. Indicate also whether a new or modified control is necessary to comply with the permit. Describe any problem condition(s) you observed such as the following:

1. Failure to install or to properly install a required P2 control
2. Damage or destruction to a P2 control caused by vehicles, equipment, or personnel, or a storm event
3. Evidence of a spill, leak, or other type of pollutant discharge, or failure to have properly cleaned up a previous spill, leak, or other type of pollutant discharge
4. Spill response supplies are absent, insufficient, or not where they are supposed to be located
5. Improper storage, handling, or disposal of chemicals, building materials or products, fuels, or wastes
6. P2 control is no longer working due to lack of maintenance
7. Other incidents of noncompliance

Describe also why you think the problem condition(s) occurred as well as actions (e.g., routine maintenance or corrective action) you will take or have taken to fix the problem.

If routine maintenance or corrective action is required, briefly note the reason. If routine maintenance or corrective action has been completed, make a note of the date it was completed and what was done. *If corrective action is required, note that you will need to complete a separate corrective action log describing the condition and your work to fix the problem.*

Routine Maintenance Need Was Found to be Necessary Three (3) or More Times for the Same Control at the Same Location (Including this Occurrence)

If routine maintenance has been required three (3) or more times for the same control at the same location, the permit requires (CGP Part 2.1.4.c) you to fix the problem using the corrective action procedures in CGP Part 5 or to document why you believe the reoccurring problem can be addressed as a routine maintenance fix. If you believe the problem can continue to be fixed as routine maintenance, describe why you believe the specific condition should still be addressed as routine maintenance.

Instructions for Section D

Specific Location That Has Been or Will Be Stabilized

List all areas where soil stabilization is required to begin because construction work in that area has permanently stopped or temporarily stopped (i.e., work will stop for 14 or more days), and all areas where stabilization has been implemented (CGP Part 2.2.14).

Stabilization Method and Applicable Deadline

For each area, specify the method of stabilization (e.g., hydroseed, sod, planted vegetation, erosion control blanket, mulch, rock).

Specify also which of the following stabilization deadlines apply to this location:

1. 5 acres or less of land disturbance occurring at any one time at site: Complete no later than 14 calendar days after stabilization initiated.
2. More than 5 acres of land disturbance occurring at any one time at site: Complete no later than 7 calendar days after stabilization initiated.
3. Arid, semi-arid, and drought-stricken areas: See CGP Part 2.2.14.b.i.
4. Unforeseen circumstances: See CGP Part 2.2.14.b.ii.
5. Discharges to a sediment- or nutrient-impaired water or to a water identified as Tier 2, 2.5, or 3 for antidegradation purposes: Complete no later than 7 days after stabilization initiated.

Stabilization Initiated?

For each area, indicate whether stabilization has been initiated. If "Yes," then enter the date stabilization was initiated.

Final Stabilization Criteria Met?

For each area, indicate whether the final stabilization criteria in CGP Part 2.2.14.c have been met. If "Yes," then enter the date final stabilization criteria were met.

Final Stabilization Photos Taken?

Answer "Yes" if you have taken photos before and after meeting the stabilization criteria as required in CGP Part 8.2.1.a.

Notes

For each area where stabilization has been initiated, describe the progress that has been made and what additional actions are necessary to complete stabilization. Note the effectiveness of stabilization in preventing erosion. If stabilization has been initiated but not completed, make a note of the date it is to be completed. If stabilization has been completed, make a note of the date it was completed. If stabilization has not yet been initiated, make a note of the date it is to be initiated and the date it is to be completed.

Instructions for Section E

You are only required to complete this section if a discharge is occurring at the time of the inspection (CGP Part 4.6.2).

Was a discharge (not including dewatering) occurring from any part of your site at the time of the inspection?

During your inspection, examine all points of discharge from your site, and determine whether a discharge is occurring. If a dewatering discharge was occurring, you must conduct a dewatering inspection pursuant to CGP Part 4.3.2. If there is a discharge, answer "Yes" and complete the questions below regarding the specific discharge. If there is not a discharge, answer "No" and skip to the next page.

Discharge Location (Repeat as necessary if there are multiple points of discharge.)

Specify the location on your site where the discharge is occurring. The location may be an outlet from a stormwater control or constructed stormwater channel, a discharge into a storm sewer inlet, or a specific point on the site. Be as specific as possible; it is recommended that you refer to a precise point on your site map.

Observations

Document the visual quality of the discharge and take note of the characteristics of the stormwater discharge, including color; odor; floating, settled, or suspended solids; foam; oily sheen; and other indicators of stormwater pollutants. Also, document signs of these same pollutant characteristics that are visible from your site and attributable to your discharge in receiving waters or in other constructed or natural site drainage features.

Instructions for Section F

Each inspection report must be signed and certified to be considered complete (CGP Part 4.7.2).

Operator or “Duly Authorized Representative” – MANDATORY (CGP Appendix G Part G.11.2 and CGP Appendix H Section X)

At a minimum, the site inspection report must be signed by either (1) the person who signed the NOI, or (2) a duly authorized representative of that person. The following requirements apply:

If the signatory will be the person who signed the NOI for permit coverage, as a reminder, that person must be one of the following types of individuals:

- *For a corporation:* By a responsible corporate officer. For the purpose of this subsection, a responsible corporate officer means: (i) a president, secretary, treasurer, or vice-president of the corporation in charge of a principal business function, or any other person who performs similar policy- or decision-making functions for the corporation, or (ii) the manager of one or more manufacturing, production, or operating facilities, provided, the manager is authorized to make management decisions which govern the operation of the regulated facility including having the explicit or implicit duty of making major capital investment recommendations, and initiating and directing other comprehensive measures to assure long term environmental compliance with environmental laws and regulations; the manager can ensure that the necessary systems are established or actions taken to gather complete and accurate information for permit application requirements; and where authority to sign documents has been assigned or delegated to the manager in accordance with corporate procedures.
- *For a partnership or sole proprietorship:* By a general partner or the proprietor, respectively.
- *For a municipality, State, Federal, or other public agency:* By either a principal executive officer or ranking elected official. For purposes of this subsection, a principal executive officer of a Federal agency includes (i) the chief executive officer of the agency, or (ii) a senior executive officer having responsibility for the overall operations of a principal geographic unit of the agency (e.g., Regional Administrator of EPA).

If the signatory will be a duly authorized representative, the following requirements must be met:

- The authorization is made in writing by the person who signed the NOI (see above);
- The authorization specifies either an individual or a position having responsibility for the overall operation of the regulated facility or activity such as the position of plant manager, operator of a well or a well field, superintendent, position of equivalent responsibility, or an individual or position having overall responsibility for environmental matters for the company. (A duly authorized representative may thus be either a named individual or any individual occupying a named position); and
- The signed and dated written authorization is included in the SWPPP. A copy must be submitted to EPA, if requested.

Sign, date and print your name and affiliation.

Contractor or Subcontractor - OPTIONAL

Where you rely on a contractor or subcontractor to complete the site inspection report, you should consider requiring the individual(s) to sign and certify each report. Note that this does not relieve you, the permitted operator, of the requirement to sign and certify the site inspection report as well. If applicable, sign, date, and print your name and affiliation.

Note

While EPA has made every effort to ensure the accuracy of all instructions contained in this template, it is the permit, not this template, that determines the actual obligations of regulated construction stormwater discharges. In the event of a conflict between this template and any corresponding provision of the CGP, you must abide by the requirements in the permit. EPA welcomes comments on this Site Inspection Report Template at any time and will consider those comments in any future revision. You may contact EPA for CGP-related inquiries at cgp@epa.gov

Appendix E – Copy of Corrective Action Log

(Note: EPA has developed a sample corrective action log that CGP operators can use. The form is available at <https://www.epa.gov/npdes/stormwater-discharges-construction-activities#resources>)

2022 CGP Corrective Action Log

Project Name: _____

NPDES ID Number: _____

Section A – Individual Completing this Log	
Name:	Title:
Company Name:	Email:
Address:	Phone Number:
Section B – Details of the Problem (CGP Part 5.4.1.a)	
Complete this section <u>within 24 hours</u> of discovering the condition that triggered corrective action.	
Date problem was first identified:	Time problem was first identified:
What site conditions triggered this corrective action? <i>(Check the box that applies. See instructions for a description of each triggering condition (1 thru 6).)</i> <input type="checkbox"/> 1 <input type="checkbox"/> 2 <input type="checkbox"/> 3 <input type="checkbox"/> 4 <input type="checkbox"/> 5a <input type="checkbox"/> 5b <input type="checkbox"/> 6	
Specific location where problem identified:	
Provide a description of the specific condition that triggered the need for corrective action and the cause (if identifiable):	
Section C – Corrective Action Completion (CGP Part 5.4.1.b)	
Complete this section <u>within 24 hours</u> after completing the corrective action.	
For site condition # 1, 2, 3, 4, or 6 (those not related to a dewatering discharge) confirm that you met the following deadlines (CGP Part 5.2.1):	
<input type="checkbox"/> Immediately took all reasonable steps to address the condition, including cleaning up any contaminated surfaces so the material will not discharge in subsequent storm events. AND	
<input type="checkbox"/> Completed corrective action by the close of the next business day, unless a new or replacement control, or significant repair, was required. OR	
<input type="checkbox"/> Completed corrective action within seven (7) calendar days from the time of discovery because a new or replacement control, or significant repair, was necessary to complete the installation of the new or modified control or complete the repair. OR	
<input type="checkbox"/> It was infeasible to complete the installation or repair within 7 calendar days from the time of discovery. Provide the following additional information: Explain why 7 calendar days was infeasible to complete the installation or repair:	

Provide your schedule for installing the stormwater control and making it operational as soon as feasible after the 7 calendar days:

For site condition # 5a, 5b, or 6 (those related to a dewatering discharge), confirm that you met the following deadlines:

- Immediately took all reasonable steps to minimize or prevent the discharge of pollutants until a solution could be implemented, including shutting off the dewatering discharge as soon as possible depending on the severity of the condition taking safety considerations into account.
- Determined whether the dewatering controls were operating effectively and whether they were causing the conditions.
- Made any necessary adjustments, repairs, or replacements to the dewatering controls to lower the turbidity levels below the benchmark or remove the visible plume or sheen.

Describe any modification(s) made as part of corrective action: (Insert additional rows below if applicable)	Date of completion:	SWPPP update necessary?	If yes, date SWPPP was updated:
1.		<input type="checkbox"/> Yes <input type="checkbox"/> No	
2.		<input type="checkbox"/> Yes <input type="checkbox"/> No	

Section D - Signature and Certification (CGP Part 5.4.2)

"I certify under penalty of law that this document and all attachments were prepared under my direction or supervision in accordance with a system designed to assure that qualified personnel properly gathered and evaluated the information contained therein. Based on my inquiry of the person or persons who manage the system, or those persons directly responsible for gathering the information, the information contained is, to the best of my knowledge and belief, true, accurate, and complete. I have no personal knowledge that the information submitted is other than true, accurate, and complete. I am aware that there are significant penalties for submitting false information, including the possibility of fine and imprisonment for knowing violations."

MANDATORY: Signature of Operator or "Duly Authorized Representative:"

Signature:	Date:
Printed Name:	Affiliation:

OPTIONAL: Signature of Contractor or Subcontractor

Signature:	Date:
Printed Name:	Affiliation:

General Instructions

This Corrective Action Log Template is provided to assist you creating a corrective action log that complies with the minimum reporting requirements of Part 5.4 of the EPA's Construction General Permit (CGP). For each triggering condition on your site, you will need to fill out a separate corrective action log.

The entire form must be completed to be compliant with the requirements of the permit. (Note: In Section C, if you do not need the number of rows provided in the corrective action log, you may delete these or cross them off. Alternatively, if you need more space to describe any modifications, you may insert additional rows in the electronic version of this form or use the bottom of the page in the field version of this form.)

If you are covered under a State CGP, this template may be helpful in developing a log that can be used for that permit; however, you will likely need to modify this form to meet the specific requirements of any State-issued permit. If your permitting authority requires you to use a specific corrective action log, you should not use this template.

Instructions for Section A

Individual completing this form Enter the name of the person completing this log. Include the person's contact information (title, affiliated company name, address, email, and phone number).

Instructions for Section B

You must complete Section B within 24 hours of discovering the condition that triggered corrective action. (CGP Part 5.4)

When was the problem first discovered?

Specify the date and time when the triggering condition was first discovered.

What site conditions triggered this corrective action? (CGP Parts 5.1 and 5.3)

Check the box corresponding to the numbered triggering condition below that applies to your site.

1. A stormwater control needs a significant repair or a new or replacement control is needed, or, in accordance with Part 2.1.4c, you find it necessary to repeatedly (i.e., 3 or more times) conduct the same routine maintenance fix to the same control at the same location (unless you document in your inspection report under Part 4.7.1c that the specific reoccurrence of this same problem should still be addressed as a routine maintenance fix under Part 2.1.4);
2. A stormwater control necessary to comply with the requirements of this permit was never installed, or was installed incorrectly;
3. Your discharges are not meeting applicable water quality standards;
4. A prohibited discharge has occurred (see Part 1.3);
5. During discharge from site dewatering activities:
 - a. The weekly average of your turbidity monitoring results exceeds the 50 NTU benchmark (or alternate benchmark if approved by EPA pursuant to Part 3.3.2b); or
 - b. You observe or you are informed by EPA, State, or local authorities of the presence of any of the following at the point of discharge to a receiving water flowing through or immediately adjacent to your site and/or to constructed or natural site drainage features or storm drain inlets:
 - sediment plume
 - suspended solids
 - unusual color
 - presence of odor
 - decreased clarity
 - presence of foam
 - visible sheen on the water surface or visible oily deposits on the bottom or shoreline of the receiving water
6. EPA requires corrective action as a result of permit violations found during an inspection carried out under Part 4.8.

Provide a description of the problem (CGP Part 5.4.1.a)

Provide a summary description of the condition you found that triggered corrective action, the cause of the problem (if identifiable), and the specific location where it was found. Be as specific as possible about the location; it is recommended that you refer to a precise point on your site map.

Instructions for Section C

You must complete Section C within 24 hours after completing the correction action. (CGP Part 5.4)

Deadlines for completing corrective action for condition # 1, 2, 3, 4, or 6 (if not relating to a dewatering discharge) (CGP Part 5.2.1)

Check the box to confirm that you met the deadlines that apply to each triggering condition. You are always required to check the first box (i.e., Immediately took all reasonable steps to address the condition, including cleaning up any contaminated surfaces so the material will not discharge in subsequent storm events.). Only one of the next three boxes should be checked depending on the situation that applies to this corrective action.

Check the second box if the corrective action for this particular triggering condition does not require a new or replacement control, or a significant repair. These actions must be completed by the close of the next business day from the time of discovery of the condition.

Check the third box if the corrective action for this particular triggering condition requires a new or replacement control, or a significant repair. These actions must be completed by no later than seven calendar days from the time of discover of the condition.

Check the fourth box if the corrective action for this particular triggering condition requires a new or replacement control, or a significant repair, and if it is infeasible to complete the work within seven calendar days. Additionally, you will need to fill out the table below the checkbox that requires:

1. An explanation as to why it was infeasible to complete the installation or repair within seven calendar days of discovering the condition.
2. Provide the schedule you will adhere to for installing the stormwater control and making it operational as soon as feasible after the seventh day following discovery.

Note: Per Part 5.2.1.c, where these actions result in changes to any of the stormwater controls or procedures documented in your SWPPP, you must modify your SWPPP accordingly within seven calendar days of completing this work.

Deadlines for completing corrective action for condition # 5a, 5b, or 6 related to a dewatering discharge (CGP Part 5.2.2)

These deadlines apply to conditions relating to construction dewatering activities. Check the box to confirm that you met the deadlines that apply to each triggering condition. You are required to check all of the boxes in this section to indicate your compliance with the corrective action deadlines.

List of modification(s) to correct problem

Provide a list of modifications you completed to correct the problem.

Date of completion

Enter the date you completed the modification. The work must be completed by the deadline you indicated above.

SWPPP update necessary?

Check "Yes" or "No" to indicate if a SWPPP update is necessary consistent with Part 7.4.1.a in order to reflect changes implemented at your site. If "Yes," then enter the date you updated your SWPPP. The SWPPP updates must be made within seven calendar days of completing a corrective action. (CGP Part 5.2.1.c)

Instructions for Section D

Each corrective action log entry must be signed and certified following completion of Section D to be considered complete. (CGP Part 5.4.2)

Operator or "Duly Authorized Representative" – MANDATORY (CGP Appendix G Part G.11.2 and CGP Appendix H Section X)

At a minimum, the corrective action log must be signed by either (1) the person who signed the NOI, or (2) a duly authorized representative of that person. The following requirements apply:

If the signatory will be the person who signed the NOI for permit coverage, as a reminder, that person must be one of the following types of individuals:

- *For a corporation:* By a responsible corporate officer. For the purpose of this subsection, a responsible corporate officer means: (i) a president, secretary, treasurer, or vice-president of the corporation in charge of a principal business function, or any other person who performs similar policy- or decision-making functions for the corporation, or (ii) the manager of one or more manufacturing, production, or operating facilities, provided, the manager is authorized to make management decisions which govern the operation of the regulated facility including having the explicit or implicit duty of making major capital investment recommendations, and initiating and directing other comprehensive measures to assure long term environmental compliance with environmental laws and regulations; the manager can ensure that the necessary systems are established or actions taken to gather complete and accurate information for permit application requirements; and where authority to sign documents has been assigned or delegated to the manager in accordance with corporate procedures.
- *For a partnership or sole proprietorship:* By a general partner or the proprietor, respectively.
- *For a municipality, State, Federal, or other public agency:* By either a principal executive officer or ranking elected official. For purposes of this subsection, a principal executive officer of a Federal agency includes (i) the chief executive officer of the agency, or (ii) a senior executive officer having responsibility for the overall operations of a principal geographic unit of the agency (e.g., Regional Administrator of EPA).

If the signatory will be a duly authorized representative, the following requirements must be met:

- The authorization is made in writing by the person who signed the NOI (see above);
- The authorization specifies either an individual or a position having responsibility for the overall operation of the regulated facility or activity such as the position of plant manager, operator of a well or a well field, superintendent, position of equivalent responsibility, or an individual or position having overall responsibility for environmental matters for the company. (A duly authorized representative may thus be either a named individual or any individual occupying a named position); and
- The signed and dated written authorization is included in the SWPPP. A copy must be submitted to EPA, if requested.

Sign, date and print your name and affiliation.

Contractor or Subcontractor - OPTIONAL

Where you rely on a contractor or subcontractor to complete this log and the associated corrective action, you should consider requiring the individual(s) to sign and certify each log entry. Note that this does not relieve you, the permitted operator, of the requirement to sign and certify the log as well. If applicable, sign, date, and print your name and affiliation.

Recordkeeping

Logs must be retained for at least 3 years from the date your permit coverage expires or is terminated. (CGP Part 5.4.4)

Keep copies of your signed corrective action log entries at the site or at an easily accessible location so that it can be made immediately available at the time of an on-site inspection or upon request by EPA. (CGP Part 5.4.3) Include a copy of the corrective action log in your SWPPP. (CGP Part 7.2.7.e)

Note

While EPA has made every effort to ensure the accuracy of all instructions contained in this template, it is the permit, not this template, that determines the actual obligations of regulated construction stormwater discharges. In the event of a conflict between this template and any corresponding provision of the CGP, you must abide by the requirements in the permit. EPA welcomes comments on this Corrective Action Log Template at any time and will consider those comments in any future revision. You may contact EPA for CGP-related inquiries at cgp@epa.gov

Appendix G –Subcontractor Certifications/Agreements

SUBCONTRACTOR CERTIFICATION
STORMWATER POLLUTION PREVENTION PLAN

Project Number: _____

Project Title: _____

Operator(s): _____

As a subcontractor, you are required to comply with the Stormwater Pollution Prevention Plan (SWPPP) for any work that you perform on-site. Any person or group who violates any condition of the SWPPP may be subject to substantial penalties or loss of contract. You are encouraged to advise each of your employees working on this project of the requirements of the SWPPP. A copy of the SWPPP is available for your review at the office trailer.

Each subcontractor engaged in activities at the construction site that could impact stormwater must be identified and sign the following certification statement:

I certify under the penalty of law that I have read and understand the terms and conditions of the SWPPP for the above designated project and agree to follow the practices described in the SWPPP.

This certification is hereby signed in reference to the above named project:

Company: _____

Address: _____

Telephone Number: _____

Type of construction service to be provided: _____

Signature: _____

Title: _____

Date: _____

Appendix H – *Sample* Grading and Stabilization Activities Log

Date Grading Activity Initiated	Description of Grading Activity	Description of Stabilization Measure and Location	Date Grading Activity Ceased (Indicate Temporary or Permanent)	Date When Stabilization Measures Initiated
INSERT DATE			INSERT DATE <input type="checkbox"/> Temporary <input type="checkbox"/> Permanent	INSERT DATE
INSERT DATE			INSERT DATE <input type="checkbox"/> Temporary <input type="checkbox"/> Permanent	INSERT DATE
INSERT DATE			INSERT DATE <input type="checkbox"/> Temporary <input type="checkbox"/> Permanent	INSERT DATE
INSERT DATE			INSERT DATE <input type="checkbox"/> Temporary <input type="checkbox"/> Permanent	INSERT DATE
INSERT DATE			INSERT DATE <input type="checkbox"/> Temporary <input type="checkbox"/> Permanent	INSERT DATE
INSERT DATE			INSERT DATE <input type="checkbox"/> Temporary <input type="checkbox"/> Permanent	INSERT DATE
INSERT DATE			INSERT DATE <input type="checkbox"/> Temporary <input type="checkbox"/> Permanent	INSERT DATE
INSERT DATE			INSERT DATE <input type="checkbox"/> Temporary <input type="checkbox"/> Permanent	INSERT DATE

Appendix I –Training Documentation



THIS CERTIFIES THAT

Ethan Schulz

has successfully completed the required course of study approved for Storm Water Pollution Prevention Plan Training for Owners and Inspectors, and is therefore awarded this

CERTIFICATE OF COMPLETION

Given this 4th day of March, 2022

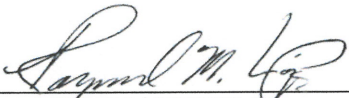

NPDES/SWPPP Instructor



Appendix J –Delegation of Authority Form

Delegation of Authority

I, _____ (name), hereby designate the person or specifically described position below to be a duly authorized representative for the purpose of overseeing compliance with environmental requirements, including the EPA's Construction General Permit (CGP), at the _____ construction site. The designee is authorized to sign any reports, stormwater pollution prevention plans and all other documents required by the permit.

_____ (name of person or position)
_____ (company)
_____ (address)
_____ (city, State, zip)
_____ (phone)

By signing this authorization, I confirm that I meet the requirements to make such a designation as set forth in Appendix G of EPA's CGP, and that the designee above meets the definition of a "duly authorized representative" as set forth in Appendix G.

I certify under penalty of law that this document and all attachments were prepared under my direction or supervision in accordance with a system designed to assure that qualified personnel properly gathered and evaluated the information submitted. Based on my inquiry of the person or persons who manage the system, or those persons directly responsible for gathering the information, the information submitted is, to the best of my knowledge and belief, true, accurate, and complete. I have no personal knowledge that the information submitted is other than true, accurate, and complete. I am aware that there are significant penalties for submitting false information, including the possibility of fine and imprisonment for knowing violations.

Name: _____

Company: _____

Title: _____

Signature: _____

Date: _____

Appendix K – Endangered Species Documentation



United States Department of the Interior



FISH AND WILDLIFE SERVICE
New Mexico Ecological Services Field Office
2105 Osuna Road Ne
Albuquerque, NM 87113-1001
Phone: (505) 346-2525 Fax: (505) 346-2542

In Reply Refer To:
Project Code: 2026-0024325
Project Name: Take 5 Oil Change

12/08/2025 21:43:17 UTC

Subject: List of threatened and endangered species that may occur in your proposed project location or may be affected by your proposed project

To Whom It May Concern:

Thank you for your recent request for information on federally listed species and important wildlife habitats that may occur in your project area. The U.S. Fish and Wildlife Service (Service) has responsibility for certain species of New Mexico wildlife under the Endangered Species Act (ESA) of 1973 as amended (16 USC 1531 *et seq.*), the Migratory Bird Treaty Act as amended (16 USC 701-715), and the Bald and Golden Eagle Protection Act as amended (16 USC 668-668(c)). We are providing the following guidance to assist you in determining which federally imperiled species may or may not occur within your project area, and to recommend some conservation measures that can be included in your project design.

The enclosed species list identifies threatened, endangered, proposed and candidate species, as well as proposed and final designated critical habitat, that may occur within the boundary of your proposed project and/or may be affected by your proposed project. The species list fulfills the requirements of the U.S. Fish and Wildlife Service (Service) under section 7(c) of the ESA of 1973, as amended (16 U.S.C. 1531 *et seq.*).

New information based on updated surveys, changes in the abundance and distribution of species, changed habitat conditions, or other factors could change this list. Please feel free to contact us if you need more current information or assistance regarding the potential impacts to federally proposed, listed, and candidate species and federally designated and proposed critical habitat. Please note that under 50 CFR 402.12(e) of the regulations implementing section 7 of the ESA, the accuracy of this species list should be verified after 90 days. The Service recommends that verification be completed by visiting the IPaC website at regular intervals during project planning and implementation for updates to species lists and information. An updated list may be requested through the IPaC system by completing the same process used to receive the enclosed list.

The purpose of the ESA is to provide a means whereby threatened and endangered species and

the ecosystems upon which they depend may be conserved. Under sections 7(a)(1) and 7(a)(2) of the ESA and its implementing regulations (50 CFR 402 *et seq.*), Federal agencies are required to utilize their authorities to carry out programs for the conservation of threatened and endangered species and to determine whether projects may affect threatened and endangered species and/or designated critical habitat.

A Biological Assessment is required for construction projects (or other undertakings having similar physical impacts) that are major Federal actions significantly affecting the quality of the human environment as defined in the National Environmental Policy Act (NEPA; 42 USC 4332(2) (c)). For projects other than major construction activities, the Service suggests that a biological evaluation similar to a Biological Assessment be prepared to determine whether the project may affect listed or proposed species and/or designated or proposed critical habitat. Recommended contents of a Biological Assessment are described at 50 CFR 402.12.

If a Federal agency determines, based on the Biological Assessment or biological evaluation, that listed species and/or designated critical habitat may be affected by the proposed project, the agency is required to consult with the Service pursuant to 50 CFR 402. In addition, the Service recommends that candidate species, proposed species and proposed critical habitat be addressed within the consultation. More information on the regulations and procedures for section 7 consultation, including the role of permit or license applicants, can be found in the "Endangered Species Consultation Handbook" at <https://www.fws.gov/sites/default/files/documents/endangered-species-consultation-handbook.pdf>.

Candidate Species and Other Sensitive Species

A list of candidate and other sensitive species in your area is also attached. Candidate species and other sensitive species are species that have no legal protection under the ESA, although we recommend that candidate and other sensitive species be included in your surveys and considered for planning purposes. The Service monitors the status of these species. If significant declines occur, these species could potentially be listed. Therefore, actions that may contribute to their decline should be avoided.

Lists of sensitive species including State-listed endangered and threatened species are compiled by New Mexico State agencies. These lists, along with species information, can be found at the following websites.

Biota Information System of New Mexico (BISON-M): www.bison-m.org

New Mexico State Forestry. The New Mexico Endangered Plant Program:
<https://www.emnrd.nm.gov/sfd/rare-plants/>

New Mexico Rare Plant Technical Council, New Mexico Rare Plants: nmrareplants.unm.edu

Natural Heritage New Mexico, online species database: nhnm.unm.edu

WETLANDS AND FLOODPLAINS

Under Executive Orders 11988 and 11990, Federal agencies are required to minimize the destruction, loss, or degradation of wetlands and floodplains, and preserve and enhance their natural and beneficial values. These habitats should be conserved through avoidance, or mitigated to ensure that there would be no net loss of wetlands function and value.

We encourage you to use the National Wetland Inventory (NWI) maps in conjunction with ground-truthing to identify wetlands occurring in your project area. The Service's NWI program website, www.fws.gov/wetlands/Data/Mapper.html, integrates digital map data with other resource information. We also recommend you contact the U.S. Army Corps of Engineers for permitting requirements under section 404 of the Clean Water Act if your proposed action could impact floodplains or wetlands.

MIGRATORY BIRDS

In addition to responsibilities to protect threatened and endangered species under the ESA, there are additional responsibilities under the Migratory Bird Treaty Act (MBTA) and the Bald and Golden Eagle Protection Act (BGEPA) to protect native birds from project-related impacts. Any activity resulting in take of migratory birds, including eagles, is prohibited unless otherwise permitted by the Service (50 CFR 10.12 and 16 USC 668(a)). For more information regarding these Acts, see <https://www.fws.gov/program/migratory-bird-permit/what-we-do>.

It is the responsibility of the project proponent to comply with these Acts by identifying potential impacts to migratory birds and eagles within applicable NEPA documents (when there is a Federal nexus) or a Bird/Eagle Conservation Plan (when there is no Federal nexus). Proponents should implement conservation measures to avoid or minimize the production of project-related stressors or minimize the exposure of birds and their resources to the project-related stressors. For more information on avian stressors and recommended conservation measures, see <https://www.fws.gov/library/collections/threats-birds>. We also recommend review of the Birds of Conservation Concern list (<https://www.fws.gov/media/birds-conservation-concern-2021>) to fully evaluate the effects to the birds at your site. This list identifies migratory and non-migratory bird species (beyond those already designated as federally threatened or endangered) that represent top conservation priorities for the Service, and are potentially threatened by disturbance, habitat impacts, or other project development activities.

In addition to MBTA and BGEPA, Executive Order 13186: *Responsibilities of Federal Agencies to Protect Migratory Birds*, obligates all Federal agencies that engage in or authorize activities that might affect migratory birds, to minimize those effects and encourage conservation measures that will improve bird populations. Executive Order 13186 thereby provides additional protection for both migratory birds and migratory bird habitat. Please visit <https://www.fws.gov/partner/council-conservation-migratory-birds> for information regarding the implementation of Executive Order 13186.

We suggest you contact the New Mexico Department of Game and Fish, and the New Mexico

Energy, Minerals, and Natural Resources Department, Forestry Division for information regarding State protected and at-risk species fish, wildlife, and plants.

For further consultation with the Service we recommend submitting inquiries or assessments electronically to our incoming email box at nmesfo@fws.gov, where it will be more promptly routed to the appropriate biologist for review.

We appreciate your concern for threatened and endangered species. The Service encourages Federal agencies to include conservation of threatened and endangered species into their project planning to further the purposes of the Act. Please include the Consultation Code in the header of this letter with any request for consultation or correspondence about your project that you submit to our office.

Attachment(s):

- Official Species List

OFFICIAL SPECIES LIST

This list is provided pursuant to Section 7 of the Endangered Species Act, and fulfills the requirement for Federal agencies to "request of the Secretary of the Interior information whether any species which is listed or proposed to be listed may be present in the area of a proposed action".

This species list is provided by:

New Mexico Ecological Services Field Office

2105 Osuna Road Ne

Albuquerque, NM 87113-1001

(505) 346-2525

PROJECT SUMMARY

Project Code: 2026-0024325
Project Name: Take 5 Oil Change
Project Type: Commercial Development
Project Description: Proposed Take 5 Oil Change drive through oil change service located at 2030 Gibson Blvd SE. The property is currently an undeveloped 0.42 AC lot.

Project Location:

The approximate location of the project can be viewed in Google Maps: <https://www.google.com/maps/@35.05793,-106.62474666316344,14z>



Counties: Bernalillo County, New Mexico

ENDANGERED SPECIES ACT SPECIES

There is a total of 4 threatened, endangered, or candidate species on this species list.

Species on this list should be considered in an effects analysis for your project and could include species that exist in another geographic area. For example, certain fish may appear on the species list because a project could affect downstream species.

IPaC does not display listed species or critical habitats under the sole jurisdiction of NOAA Fisheries¹, as USFWS does not have the authority to speak on behalf of NOAA and the Department of Commerce.

See the "Critical habitats" section below for those critical habitats that lie wholly or partially within your project area under this office's jurisdiction. Please contact the designated FWS office if you have questions.

-
1. [NOAA Fisheries](#), also known as the National Marine Fisheries Service (NMFS), is an office of the National Oceanic and Atmospheric Administration within the Department of Commerce.

MAMMALS

NAME	STATUS
New Mexico Meadow Jumping Mouse <i>Zapus hudsonius luteus</i> There is final critical habitat for this species. Your location does not overlap the critical habitat. Species profile: https://ecos.fws.gov/ecp/species/7965 General project design guidelines: https://ipac.ecosphere.fws.gov/project/SC244PUGJJB5HGVD SHWPZL3R3Y/documents/generated/9163.pdf	Endangered

BIRDS

NAME	STATUS
Yellow-billed Cuckoo <i>Coccyzus americanus</i> Population: Western U.S. DPS There is final critical habitat for this species. Your location does not overlap the critical habitat. Species profile: https://ecos.fws.gov/ecp/species/3911 General project design guidelines: https://ipac.ecosphere.fws.gov/project/SC244PUGJJB5HGVD SHWPZL3R3Y/documents/generated/9183.pdf	Threatened

INSECTS

NAME	STATUS
Monarch Butterfly <i>Danaus plexippus</i> There is proposed critical habitat for this species. Your location does not overlap the critical habitat. Species profile: https://ecos.fws.gov/ecp/species/9743	Proposed Threatened
Suckley's Cuckoo Bumble Bee <i>Bombus suckleyi</i> Population: No critical habitat has been designated for this species. Species profile: https://ecos.fws.gov/ecp/species/10885	Proposed Endangered

CRITICAL HABITATS

THERE ARE NO CRITICAL HABITATS WITHIN YOUR PROJECT AREA UNDER THIS OFFICE'S JURISDICTION.

YOU ARE STILL REQUIRED TO DETERMINE IF YOUR PROJECT(S) MAY HAVE EFFECTS ON ALL ABOVE LISTED SPECIES.

IPAC USER CONTACT INFORMATION

Agency: Private Entity
Name: Nicholas Merelli
Address: 5500 Greenwood Plaza Blvd, Suite 200
City: Greenwood Village
State: CO
Zip: 80111
Email: nicholasmerelli@gallowayus.com
Phone: 3039628423

Appendix L – Historic Properties Documentation

Previous development at this project site has proven historical properties are not located onsite

Appendix M – Rainfall Gauge Recording

Use the table below to record the rainfall gauge readings at the beginning and end of each work day. An example table follows.

Month/Year			Month/Year			Month/Year		
Day	Start time	End time	Day	Start time	End time	Day	Start time	End time
1			1			1		
2			2			2		
3			3			3		
4			4			4		
5			5			5		
6			6			6		
7			7			7		
8			8			8		
9			9			9		
10			10			10		
11			11			11		
12			12			12		
13			13			13		
14			14			14		
15			15			15		
16			16			16		
17			17			17		
18			18			18		
19			19			19		
20			20			20		
21			21			21		
22			22			22		
23			23			23		
24			24			24		
25			25			25		
26			26			26		
27			27			27		
28			28			28		
29			29			29		
30			30			30		
31			31			31		

Example Rainfall Gauge Recording

April 2022			May 2022			June 2022		
Day	7:00 am	4:400 pm	Day	7:00 am	4:00 pm	Day	7:00 am	4:00 pm
1	--	--	1	0.2	0	1	0	0.4
2	--	--	2	0	0	2	0	0
3	0	0	3	0.1	0.3	3	--	--
4	0	0.3	4	0	0	4	--	--
5	0	0	5	0	0	5	0	0

In this example (for only partial months), 0.25-inch rainfall inspections would have been conducted on April 4 and June 1.

Appendix N – Turbidity Monitoring Sampling Documentation

N/A – Dewatering is not anticipated